



2720 Tobey Drive, Indianapolis, IN 46219
 Tel 1-877-671-7011 ■ Fax 800-851-0000
 Zero.Customer.Support@allegion.com
 www.zerointernational.com

Part No:

35/38

Part description:

Meeting stile

Notes:

Provided by:

Customer name:

Job no:

Date:

Image may not be shown to scale

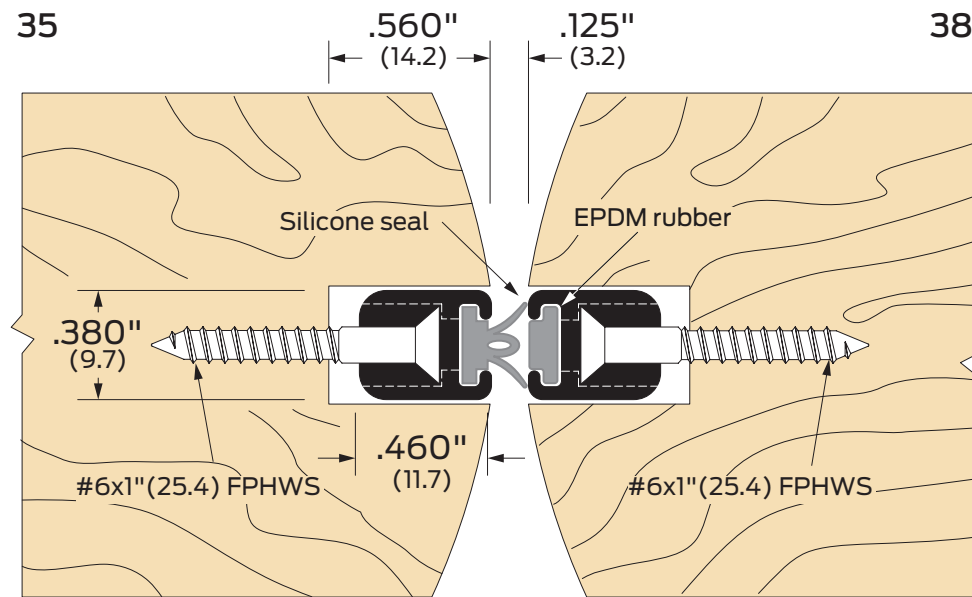

Notes:

Order components separately.

Certifications:

Fire rated-UL10c

ANSI/BHMA:

35AA, 35BK, 35D, 35G

R3E824

Finishes:

- AA** Aluminum clear anodized
- BK** Aluminum black anodized
- D** Aluminum dark bronze anodized
- G** Aluminum gold anodized

