



D-1026

# F-XX-C-LBR & XX-C-LBR

# FALCON®

Exit Devices

Installation Instructions

## 8 REVERSING INSTRUCTIONS

### TO REVERSE THE HANDING OF A (F)XX-C-LBR DEVICE

NOTE: TO REVERSE TRIM, REFER TO SEPARATE INSTALLATION SHEETS.

1. REMOVE CHASSIS COVER AND FOUR SCREWS (NOT SHOWN) FROM BOTH ACTIVE AND INACTIVE HEADS.
2. SLIDE CHASSIS COVERS BACK AND REMOVE AXLE FROM CROSS BAR ARM.
3. REMOVE CHASSIS COVERS FROM HEADS.
4. SWITCH ARMS FROM ACTIVE TO INACTIVE HEADS.
5. RE-INSTALL AXLE THRU HEADS AND CROSS BAR ARMS.
6. CHECK FOR PROPER FUNCTION.
7. FOR PANIC DEVICES, SWITCH LOCATION OF MOUNTING BRACKET ON TOP LATCH TO OPPOSITE SIDE.
8. PROCEED WITH DEVICE INSTALLATION.

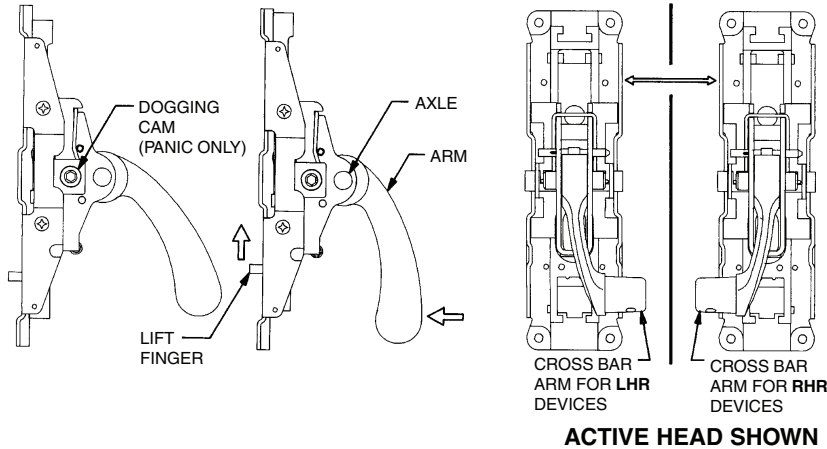

ACTIVE HEAD SHOWN

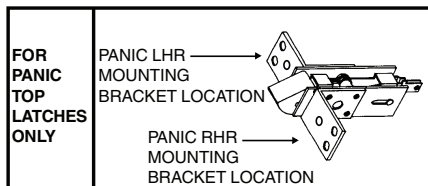

## 1 PARTS CHECK

- 1) MAKE SURE THE CORRECT DEVICE IS BEING USED AND IS THE CORRECT HANDING.  
(SEE PAGE 12 FOR REVERSING INSTRUCTIONS).
- 2) MAKE SURE ALL NEEDED PARTS ARE ON HAND.

NOTE: LIST DOES NOT REFLECT ALL POSSIBLE APPLICATIONS

<b>1. (F) XX-C DEVICE</b>  NOTE: DEVICE IS FIELD REVERSIBLE	<b>4. CENTERSLIDE</b> 	<b>7. SCREW PACK</b> DOGGING KEY (1 QTY) PANIC ONLY #10-24x3/4" PPHMS (8 QTY) #10-24x3/4" FPHMS (11 QTY, 2 FINISHED) #8-32x3/8" UFPHMS (2 QTY) COTTER KEY (1 QTY) RELEASE BRACKET (1 QTY)
<b>2. STRIKES</b> 4188 TOP STRIKE 	<b>5. VERTICAL RODS</b> TOP ROD (37-1/4" FOR 7'0" DOOR) 	
<b>3. TOP LATCHES</b> FIRE PANIC	<b>6. CROSSBAR</b> 	

- 3) MAKE SURE OUTSIDE TRIM (IF BEING USED) HAS BEEN PROVIDED AND IS THE CORRECT HANDING.



Customer Service

1-877-671-7011 www.allegion.com/us

## 2 DOOR LAYOUT

**NOTE: FOR FACTORY PREPARED DOORS, VERIFY LAYOUT.**

- 1) DOOR MUST BE FITTED AND HUNG PROPERLY BEFORE PROCEEDING.
- 2) MARK VERTICAL  $\zeta$ , DEVICE REF.  $\zeta$  AND HORIZONTAL  $\zeta$  ON DOOR AND FRAME. (SEE FIGURES AND CHART BELOW)

### A. VERTICAL $\zeta$

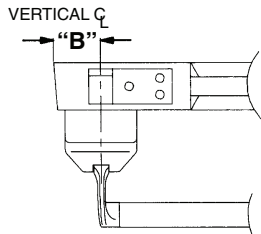

LHR SHOWN

PANIC TOP  
LATCH  
SHOWN

DEVICE BACKSET "B" CHART	
STILE	BACKSET
3" Min to 4-1/2"	Half of Stile
4-1/2" to Flush	2-3/4"

**NOTE: Fire application requires a 2-3/4" backset**

### B. DEVICE REF. $\zeta$ AND HORIZONTAL $\zeta$

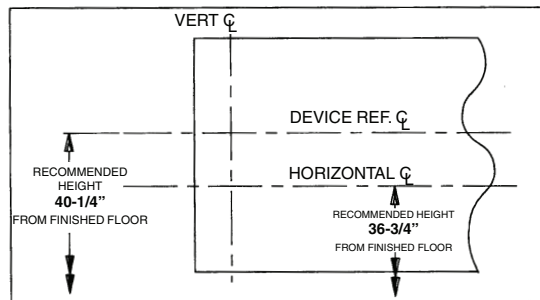

LHR SHOWN

- 3) MARK LOCATION OF RELEASE BRACKET ACCESS HOLE ON VERTICAL  $\zeta$  AT TOP OF DOOR AS SHOWN BELOW.

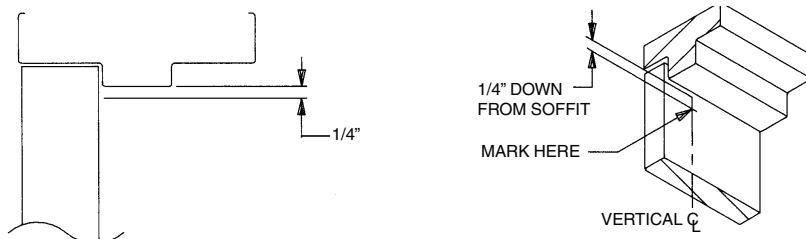

## 7 ADJUSTMENT

- 1) WITH THE LATCH BOLT PROJECTED, **SLOWLY** DEPRESS CROSS BAR. TOP LATCH BOLT SHOULD REMAIN IN RETRACTED POSITION. IF NOT, TURN TOP ADJUSTMENT PIN COUNTER CLOCKWISE BY 1/2 TURN AND **SLOWLY** PUSH CROSS BAR, TOP LATCH BOLT SHOULD REMAIN IN RETRACTED POSITION. IF NOT, REPEAT THIS PROCESS UNTIL TOP LATCH BOLT REMAINS RETRACTED.

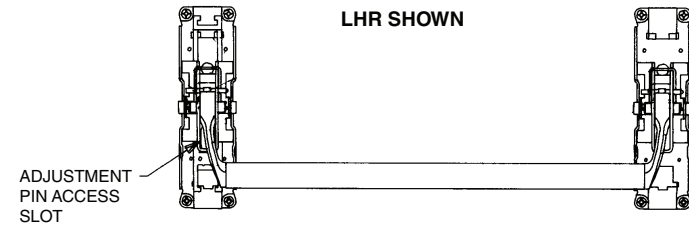

- 2) RELEASE TOP LATCH BOLT USING TOOL. OPERATE DEVICE SEVERAL TIMES TO CHECK ADJUSTMENT BY **SLOWLY** PUSHING ON CROSS BAR, CHECKING TOP LATCH BOLT RETRACTION, AND THEN RELEASING THE TOP LATCH BOLT EACH TIME.
- 3) CHECK DOGGING OPERATION (PANIC APPLICATION ONLY).
  - A) PUSH CROSS BAR, THEN INSERT AND TURN DOGGING KEY CLOCKWISE. IF YOU CANNOT TURN DOGGING KEY WHILE PUSHING CROSS BAR, REDUCE THE TOP LATCH BOLT PROJECTION BY USING THE ADJUSTMENT PINS IN THE CENTERSLIDE (REFER TO STEP 1 ABOVE AND PAGE 7, STEP 2B). REPEAT UNTIL CROSS BAR IS DOGGED AND LATCH IS HELD RETRACTED.
  - B) AFTER REMOVING THE DOGGING KEY, THE CROSS BAR SHOULD REMAIN RETRACTED.
  - C) RE-INSERT THE DOGGING KEY AND TURN IN OPPOSITE DIRECTION. CROSS BAR WILL "POP OUT".
  - D) FOR CYLINDER DOGGING, REFER TO INSTRUCTION D-4085.
- 4) INSTALL RELEASE BRACKET, REFER TO DEVICE DRILLING TEMPLATE DT-1030. ALLOW DOOR TO CLOSE TO SEE IF THE PLUNGER WILL RELEASE THE TOP LATCH BOLT. IF THE PLUNGER STOPS THE DOOR FROM SWINGING TO THE DOOR STOP, ADJUST THE PLUNGER IN USING AN ALLEN WRENCH; IF THE TOP LATCH BOLT DOES NOT RELEASE, ADJUST THE PLUNGER OUT.
- 5) CHECK DEVICE FOR SMOOTH OPERATION AND LATCH BOLT ENGAGEMENT.
- 6) RE-INSTALL CHASSIS COVER.
  - A) REMOVE AXLES FROM BOTH ACTIVE AND INACTIVE CHASSIS.
  - B) REMOVE CROSSBAR AND CROSSBAR ARMS FROM BOTH CHASSIS.
  - C) SLIDE CROSSBAR ARMS INTO RECTANGULAR CUT-OUT IN TOP OF CHASSIS COVER.
 

**NOTE: THE 1/2" DIA. HOLE IN THE CHASSIS COVER ON BOTH COVERS SHOULD FACE EACH OTHER.**
  - D) INSERT CROSSBAR ARMS INTO CHASSIS AND INSERT AXLES.
  - E) SLIDE CHASSIS COVER OVER CHASSIS AND ATTACH WITH 4 (PER HEAD) #8-32x1/4" UPPHMS.
- 7) FOR F-XX-C-LBR DEVICES ONLY, INSTALL SPRING BOLT PLUNGER, REFER TO INSTRUCTION D-5494.

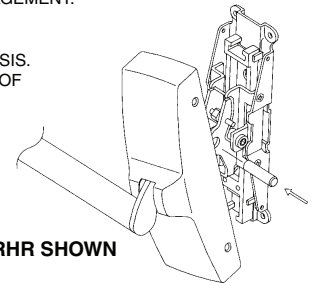

RHR SHOWN

- 7) INSERT A TOOL INTO THE RELEASE BRACKET ACCESS HOLE AND PUSH THE TOP LATCH BOLT RETAINER. THE LATCH BOLT SHOULD RELEASE, PULL DOWN ON THE LIFT TAB AND THE LATCHBOLT SHOULD GO INTO THE FULLY PROJECTED POSITION.
- 8) REPEAT STEPS 6 THRU 8 SEVERAL TIMES, CHECKING FOR BINDS OR ROUGH ACTION IN THE CENTERSLIDE AND TOP LATCH.
- 9) RE-HANG THE DOOR IN THE OPENING.

## 6 DEVICE, STRIKE AND TRIM INSTALLATION

- 1) IF USING OUTSIDE TRIM OR SEXBOLTS, MOUNT TRIM PER DIRECTIONS IN TRIM BOX, OR INSTALL OUTSIDE SEXBOLTS.
- 2) SURFACE MOUNT DEVICE USING FOUR #10-24x3/4" PPHMS NOTING THE ALIGNMENT BETWEEN THE LIFT FINGER ON THE DEVICE HEAD AND THE LIFT TAB ON THE CONCEALED CENTERSLIDE (SEE BELOW).

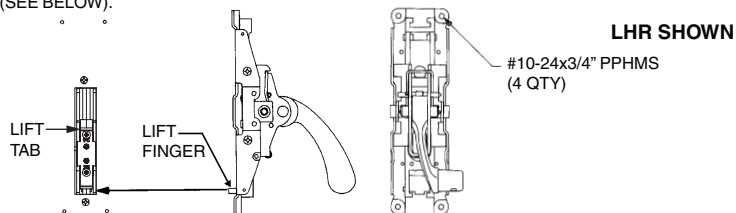

- 3) REMOVE CROSSBAR RETAINER SCREW AND ROUNDED WASHER FROM XX CROSSBAR ARMS. SLIDE THE CROSSBAR OVER BOTH THE ACTIVE AND INACTIVE ARMS AND ATTACH WITH CROSSBAR RETAINER SCREW AND ROUNDED WASHER.

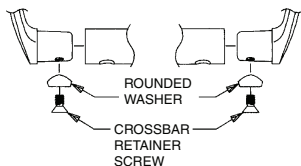

- 4) LOCATE, MARK AND DRILL INACTIVE HEAD MONTING HOLES.
  - A) LEVEL CROSSBAR ON DOOR AND MARK CENTER OF FOUR MOUNTING HOLES.
  - B) PREPARE HOLES FOR MOUNTING SCREWS:
    - FOR SHEET METAL SCREWS: DRILL 9/64" DIA. HOLES
    - FOR MACHINE SCREWS: DRILL & TAP #10-24
    - FOR MACHINE SCREWS WITH SEXBOLTS: DRILL 7/32" DIA. HOLE THRU DOOR AND DRILL 3/8" DIA. HOLE ON OPPOSITE SIDE OF DOOR USING 7/32" DIA. HOLE AS PILOT.

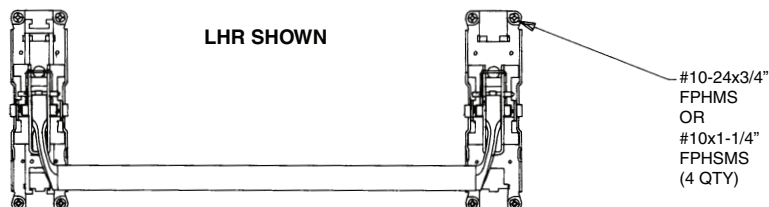

- 5) INSTALL TOP STRIKE USING TWO #10-24x3/4" FPHMS, REFER TO DRILLING TEMPLATE DT-1030.

## 3 DOOR & HARDWARE PREPARATION

- 1) REMOVE DOOR FROM OPENING AND LAY FLAT.
- 2) TAPE DEVICE DRILLING TEMPLATE ALONG HORIZONTAL AND VERTICAL CENTERLINES. CENTER PUNCH AND PREPARE HOLES AS SPECIFIED.
- 3) PREPARE DOOR FOR TOP LATCH AS SHOWN ON DEVICE DRILLING TEMPLATE FROM THE CENTER OF THIS BOOK.
- 4) PREPARE FRAME FOR TOP STRIKE PER DEVICE DRILLING TEMPLATE FROM CENTER OF THIS BOOK.
- 5) DRILL 1/2" DIA. RELEASE BRACKET ACCESS HOLE AT LOCATION SPECIFIED ON PAGE 2, STEP 3.
- 6) IF USING OUTSIDE TRIM, PREPARE TRIM SIDE OF DOOR USING SEPARATE TRIM DIRECTION SHEET. FOR SEXBOLT INSTALLATIONS, PREPARE DOOR AS SHOWN BELOW.

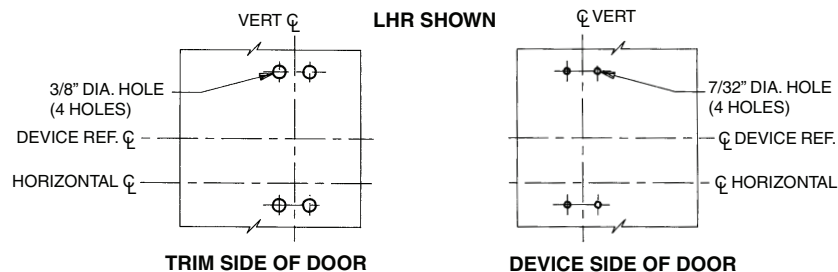

- 7) DETERMINE CROSSBAR LENGTH.
  - A. MEASURE DISTANCE BETWEEN VERTICAL C AND EDGE OF DOOR (DIMENSION "Y" BELOW).
  - B. CALCULATE CROSSBAR LENGTH "X" USING FORMULA BELOW:

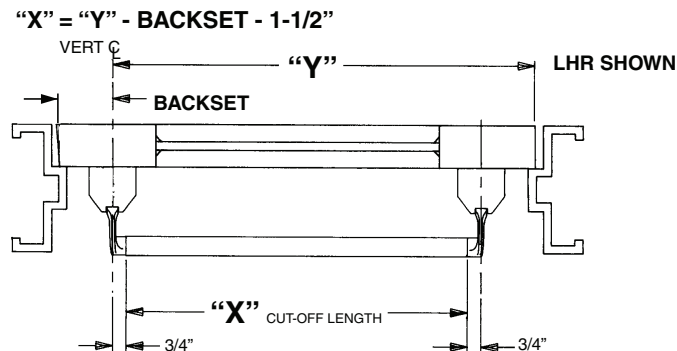

- 8) IF CROSSBAR IS LONGER THAN "X", CUT THE DEVICE.  
 A. MARK CROSSBAR TO LENGTH "X".

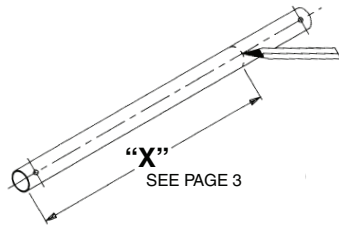

- B. CUT CROSSBAR TO MARKED DIMENSION AND REMOVE BURRS.

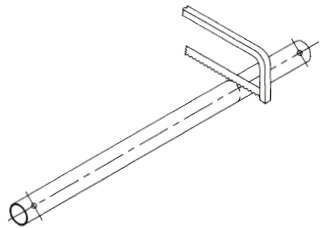

**NOTE: FACTORY RECOMMENDS SAWING RATHER THAN CUT GRIND TO SIZE. GRINDING CAN DAMAGE THE FINISH OF THE DEVICE AND SAWING RESULTS IN LESS DAMAGE TO THE DEVICE'S FINISH.**

- C. DRILL A 5/16" DIA. HOLE 5/8" FROM THE JUST CUT END OF THE CROSSBAR.

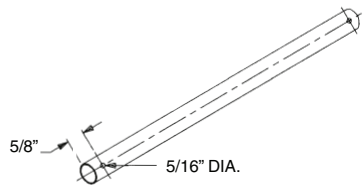

- 9) IF DOOR OPENING IS NOT 7'0", DETERMINE TOP ROD LENGTH BASED ON A 40-1/4" DEVICE REF. Q FROM THE FINISHED FLOOR.

- A. FOR DOOR OPENINGS UNDER 7'0":  
 1. SUBTRACT DOOR OPENING FROM 7'0".  
 2. SUBTRACT ANSWER FROM PART 1 FROM 37-1/4" TO DETERMINE TOP ROD LENGTH.  
 (EXAMPLE: 6'8" OPENING: 7'0" - 6'8" = 4"; 37-1/4" - 4" = 33-1/4" TOP ROD)
- B. FOR DOOR OPENINGS OVER 7'0":  
 1. SUBTRACT 7'0" FROM DOOR OPENING.  
 2. ADD ANSWER FROM PART 1 TO 37-1/4" TO DETERMINE TOP ROD LENGTH.  
 (EXAMPLE: 8'10" OPENING: 8'10" - 7'0" = 22"; 37-1/4" + 22" = 59-1/4" TOP ROD)

- 4) TURN THE TOP ADJUSTMENT PIN CLOCKWISE (MOVING THE LIFT TAB TOWARDS THE TOP LATCH) OR COUNTER-CLOCKWISE (MOVING THE LIFT TAB TOWARDS THE BOTTOM OF THE DOOR) UNTIL THE LIFT TAB IS POSITIONED LIKE THIS.

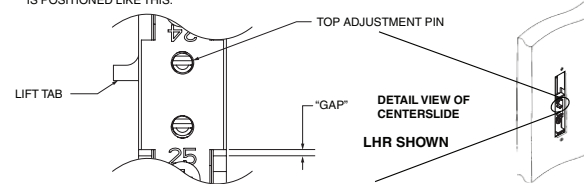

- 5) TURN THE TOP ADJUSTMENT PIN COUNTER-CLOCKWISE UNTIL THE LIFT TAB MOVES TOWARDS THE BOTTOM OF THE DOOR AND CLOSES THE "GAP".

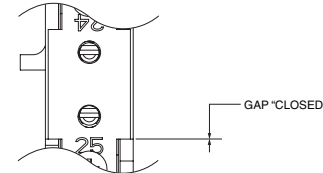

- 6) LIFT ON THE LIFT TAB UNTIL THE TOP LATCH BOLT IS FULLY RETRACTED. ATTEMPT TO SLIDE THE THE CENTERSLIDE THE OPPOSITE DIRECTION, THE CENTERSLIDE SHOULD NOT MOVE AND THE TOP LATCH BOLT SHOULD REMAIN IN THE RETRACTED POSITION. IF NOT, TURN THE TOP ADJUSTMENT PIN ONE QUARTER TURN COUNTER-CLOCKWISE AND TRY AGAIN. REPEAT UNTIL THE TOP LATCH BOLT REMAINS RETRACTED.

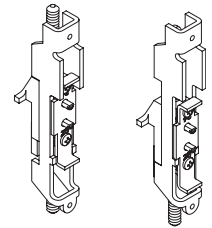
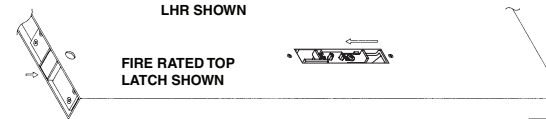

# 5 CONCEALED VERTICAL ROD ASSEMBLY INSTRUCTION

1) THREAD BOTH THE TOP ROD AND BOTTOM ROD & BOLT ASSEMBLY ONTO THE CENTERSLIDE. INSERT COTTER KEY THRU ROD AND ROD CONNECTORS AND BEND, ASSEMBLING THE ROD AND TOP LATCH TOGETHER.



FIRE RATED TOP LATCH SHOWN

2) LAY TOP LATCH, RODS AND CENTERSLIDE ASSEMBLY ONTO SURFACE OF DOOR (AS SHOWN BELOW). ALIGN ASSEMBLY AS IF IT WAS INSTALLED INSIDE THE DOOR AND PERFORM ADJUSTMENT AS DETAILED BELOW.

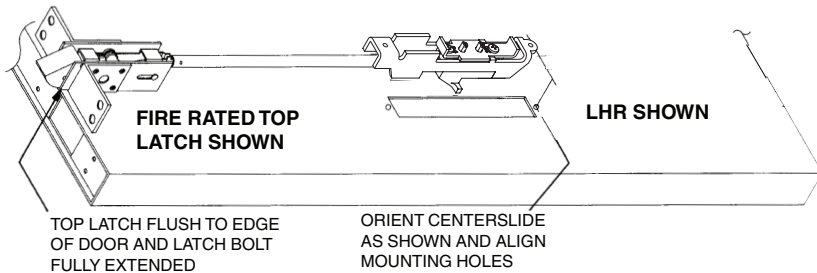

FIRE RATED TOP LATCH SHOWN

LHR SHOWN

TOP LATCH FLUSH TO EDGE OF DOOR AND LATCH BOLT FULLY EXTENDED

ORIENT CENTERSLIDE AS SHOWN AND ALIGN MOUNTING HOLES

3) PICK UP THE ENTIRE ASSEMBLY AND INSERT CENTERSLIDE INTO TOP LATCH CUT-OUT. SLIDE ASSEMBLY THRU DOOR UNTIL THE TOP LATCH SEATS INTO THE MATING PREPARATION. ATTACH CENTERSLIDE AND TOP LATCH TO DOOR USING SCREWS LISTED BELOW:

TOP LATCH: #10-24x3/4" FPHMS (4 FOR FIRE OR 3 FOR PANIC)  
CENTERSLIDE: #8-32x3/8" UFPHMS (2 QTY)

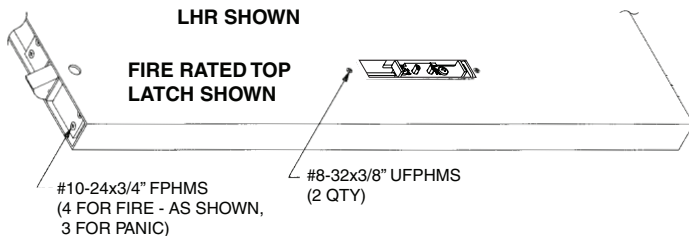

LHR SHOWN

FIRE RATED TOP LATCH SHOWN

#10-24x3/4" FPHMS (4 FOR FIRE - AS SHOWN, 3 FOR PANIC)

#8-32x3/8" UFPHMS (2 QTY)

10) MODIFY TOP ROD TO REQUIRED LENGTH.

A. FOR TOP RODS THAT ARE TOO LONG, FOLLOW PROCEDURE BELOW TO CUT ROD TO SIZE.

1. MARK ROD TO REQUIRED LENGTH.

NOTE: ROD MUST BE MEASURED FROM THREADED PORTION OF ROD.

**DO NOT CUT ROD AT END WITH INTERNAL THREADS.**

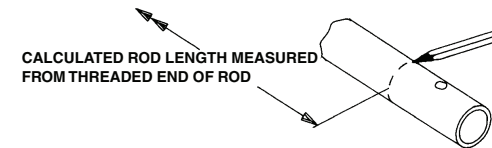

CALCULATED ROD LENGTH MEASURED FROM THREADED END OF ROD

2. CUT ROD AT MARKED LOCATION.

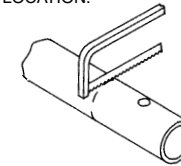

3. DRILL COTTER KEY CONNECTION HOLE.

DRILL 1/8" DIA. HOLE THRU ON VERTICAL ROD 7/16" FROM END OF ROD JUST CUT.

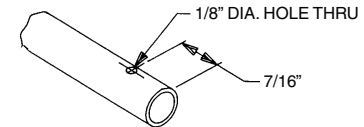

1/8" DIA. HOLE THRU

7/16"

B. FOR TOP RODS THAT ARE TOO SHORT, FOLLOW PROCEDURE BELOW:

1. ATTACH EXTENSION RODS TO THREADED SECTION OF TOP ROD.



TOP ROD

NOTE: USE VISE GRIPS OR PLIERS TO SECURE RODS TOGETHER TIGHTLY

EXTENSION ROD

2. CHECK TOP ROD AND EXTENSION ROD ASSEMBLY FOR STRAIGHTNESS.

3. FOLLOW INSTRUCTIONS TO MARK, CUT AND DRILL TOP ROD (SEE ABOVE).

# 4 OPERATIONAL REVIEW

## 1) TOP LATCH FUNCTION.

A. WITH THE LATCH BOLT RETRACTED, PULL ON THE ROD CONNECTOR. THE LATCH BOLT WILL REMAIN RETRACTED.

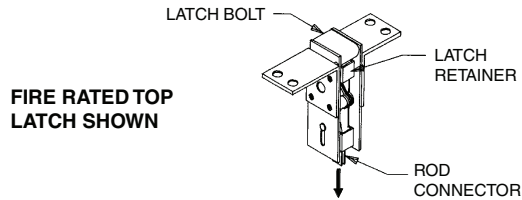

B. PULL ON THE ROD CONNECTOR AND PUSH ON THE LATCH RETAINER. THE LATCH BOLT WILL EXTEND.

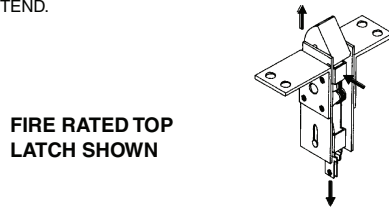

C. PUSH ON ROD CONNECTOR. THE LATCH BOLT WILL RETRACT AND REMAIN RETRACTED.

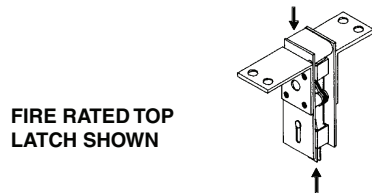

## 2. CENTERSLIDE FUNCTION.

A. PLACE THE CENTERSLIDE IN YOUR HAND. LIFT UP ON THE LIFT TAB TO CHECK IF THE CENTERSLIDE CAN MOVE FREELY (AS SHOWN BELOW). ALSO, NOTE THE LOCATIONS SHOWN FOR DEVICE LIFTING AND TRIM LIFTING.

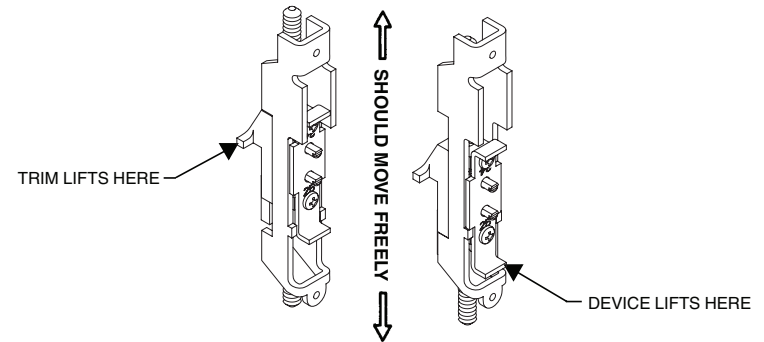

B. USING A SMALL FLAT-BLADE SCREW DRIVER, PUSH IN GENTLY ON THE TWO ADJUSTMENT PINS AND TURN. THE ROD CONNECTOR SCREW WILL ROTATE. (THIS IS THE VERTICAL ROD ADJUSTMENT FEATURE).

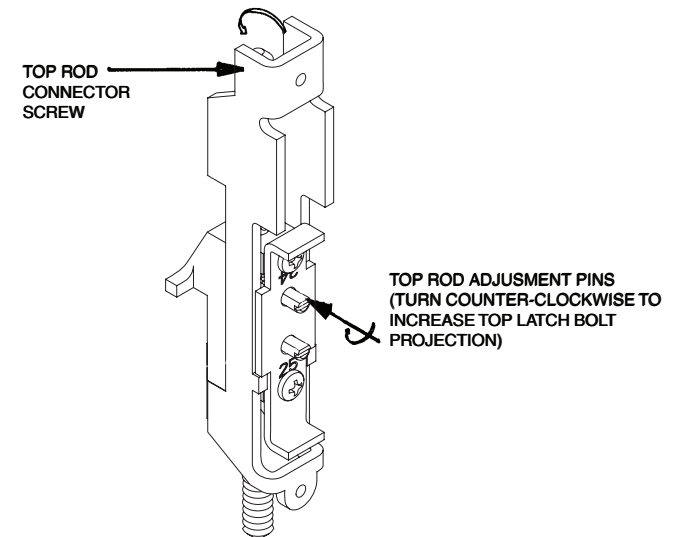

**XX Series Concealed Vertical Rod  
Panic & Fire Exit Devices  
DRILLING TEMPLATE**

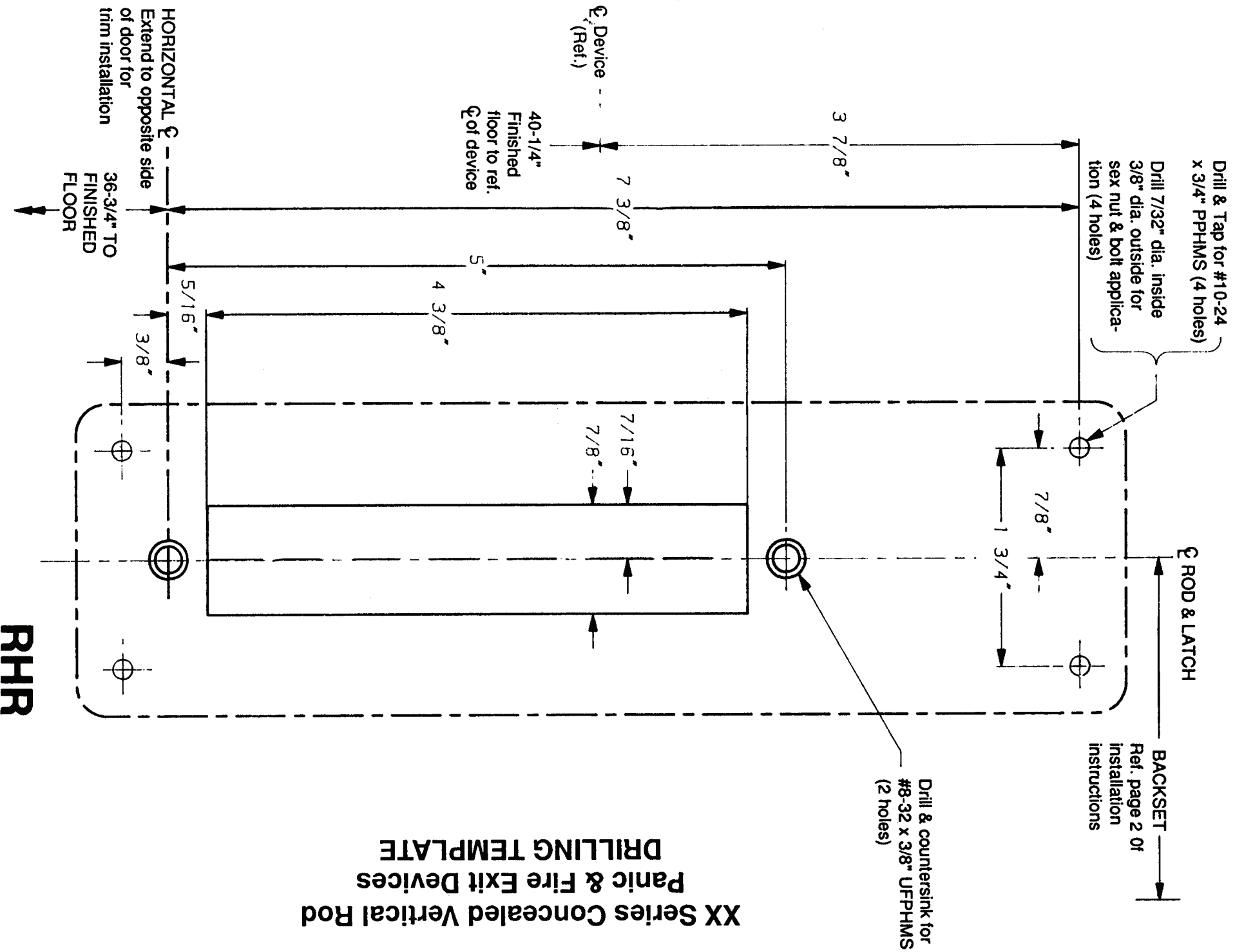

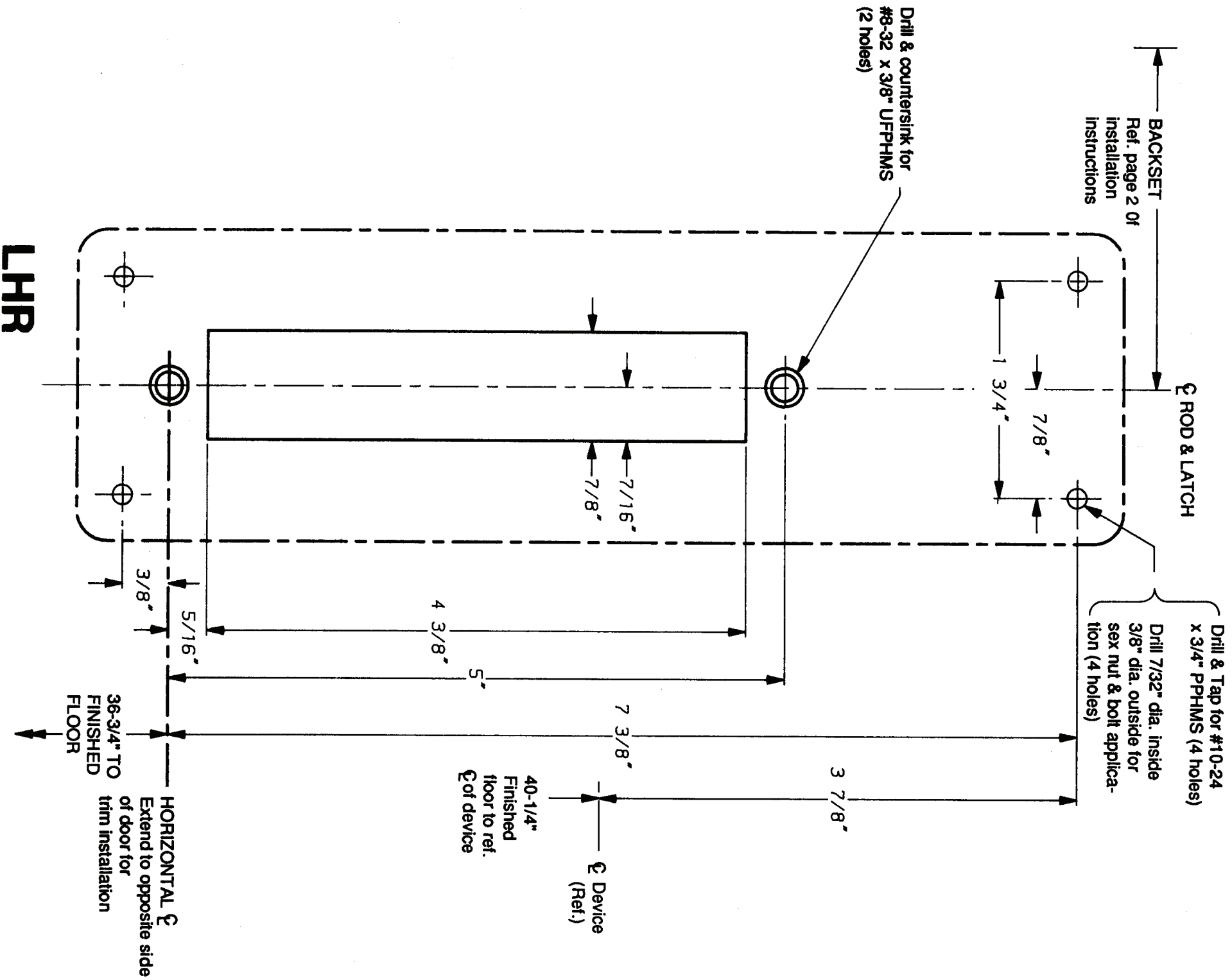



# SOFFIT STRIKE & RELEASE BRACKET TEMPLATE

Ø ROD & LATCH

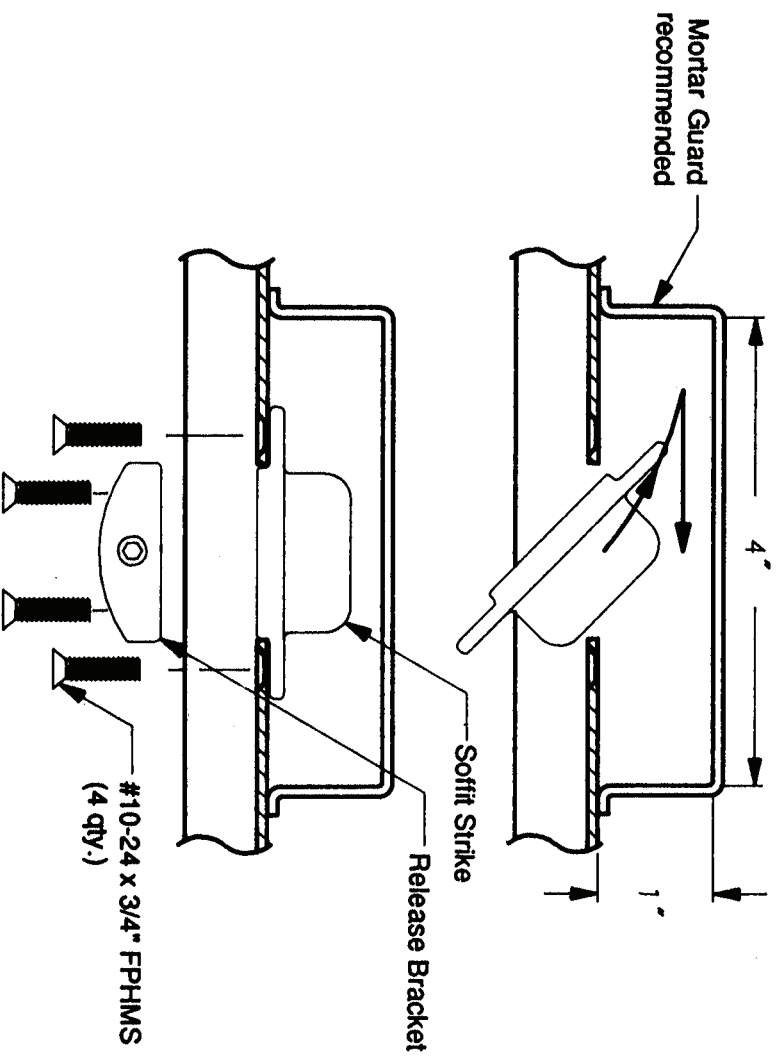
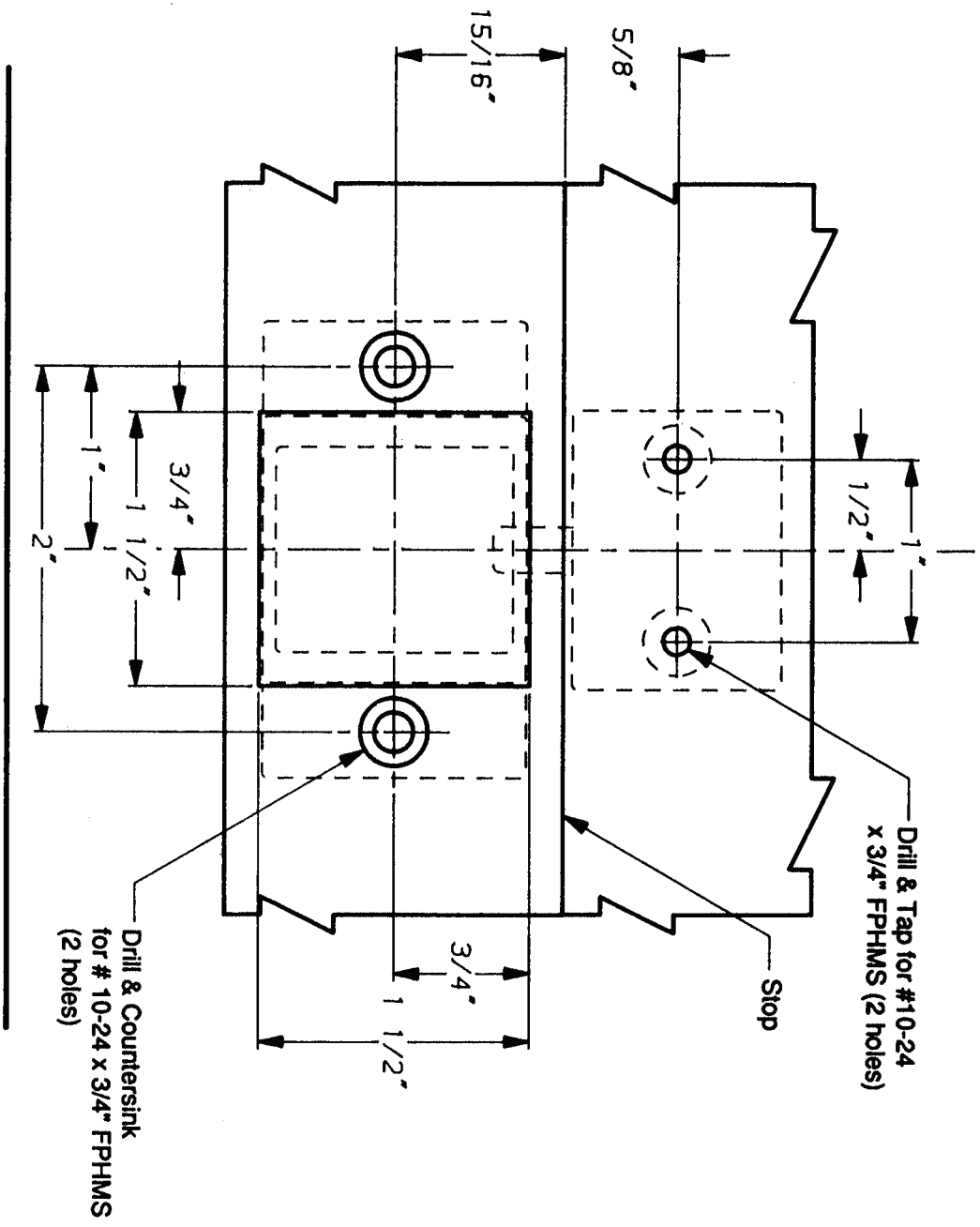

## TOP LATCH PREPARATION

L H R Shown

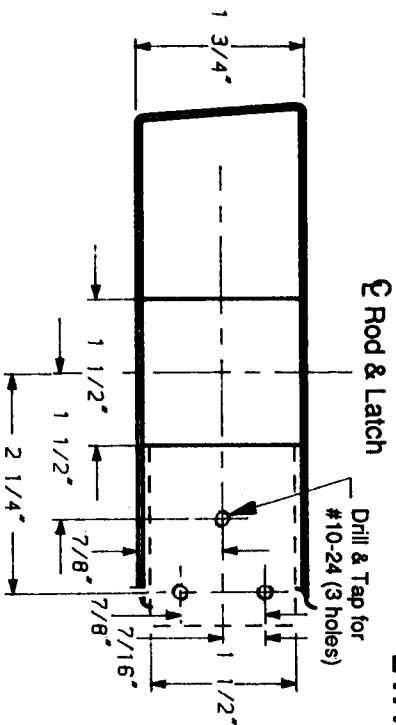

⌀ Rod & Latch

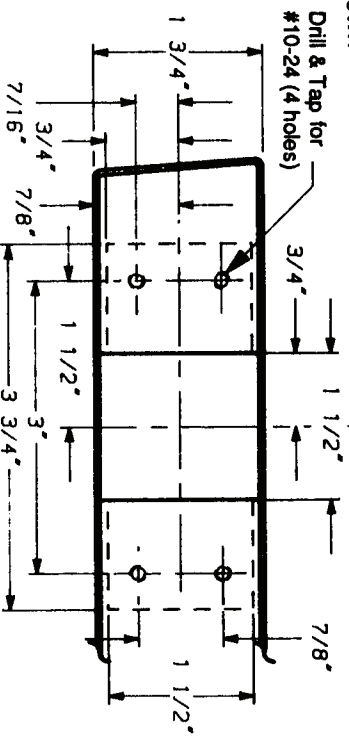

⌀ Rod & Latch

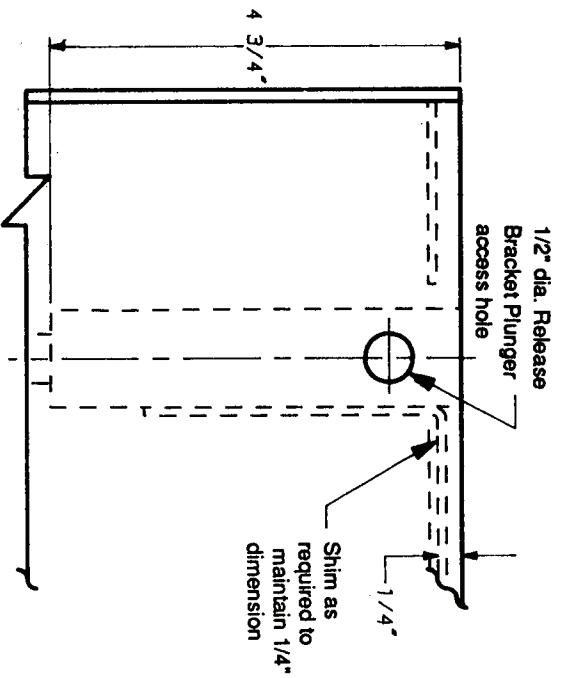

Panic

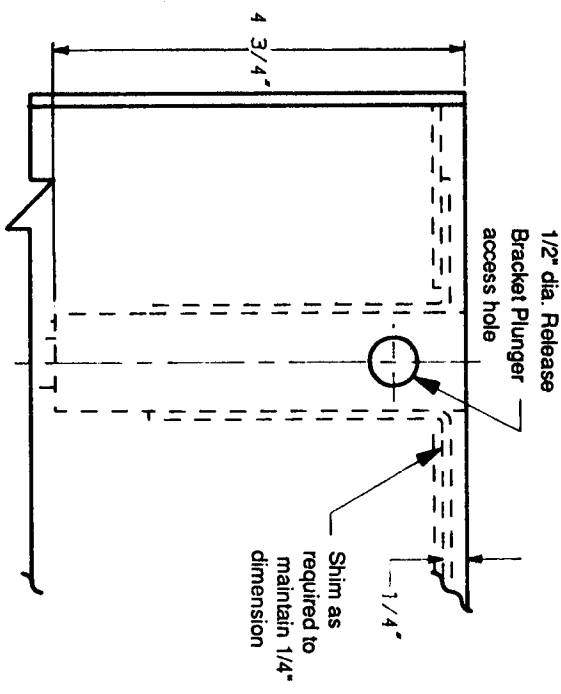

Fire

## BOTTOM BOLT GUIDE PREPARATION

L H R Shown

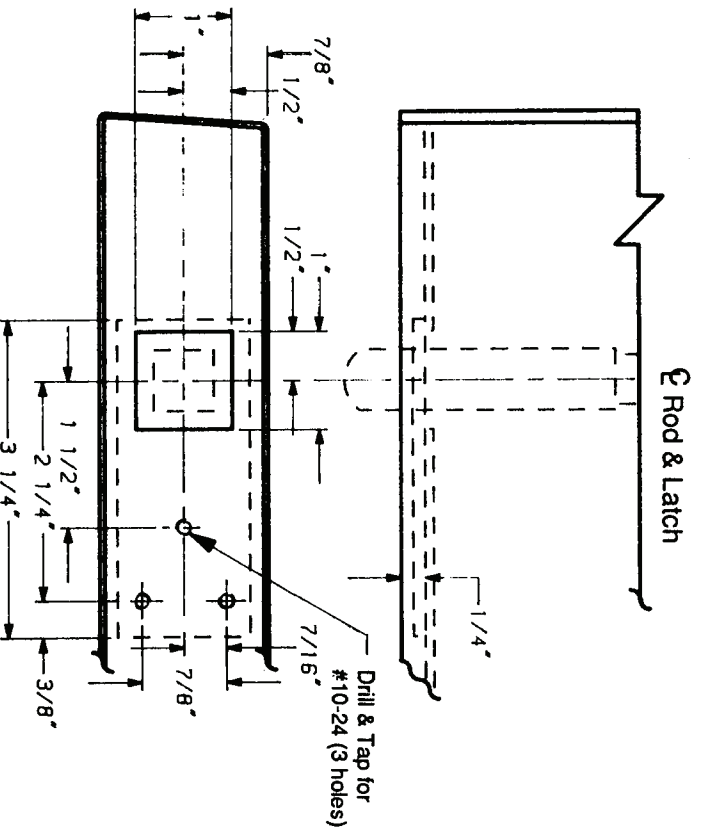

⌀ Rod & Latch

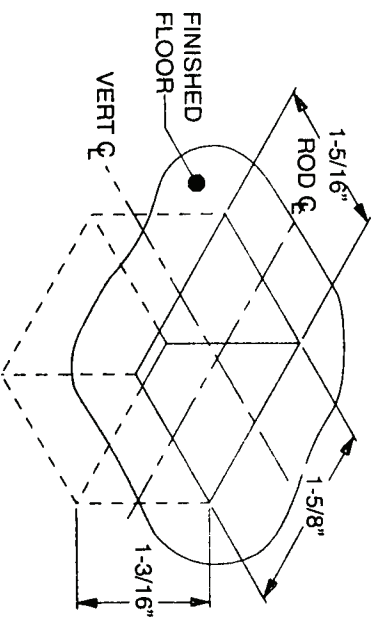

## CAVITY PREPARATION FOR 2130 BOTTOM STRIKE