



43035

SC80 Series/Serie/Série

FALCON®

Heavy Duty Arm Models, SC81 (1-6 Adj.)
Modelos con brazo para uso industrial, SC81 (1-6 Adj.)
Modèles avec bras à usage industriel, SC81 (1-6 adj.)

Installation Instructions
Instrucciones de Instalación
Instructions d'installation

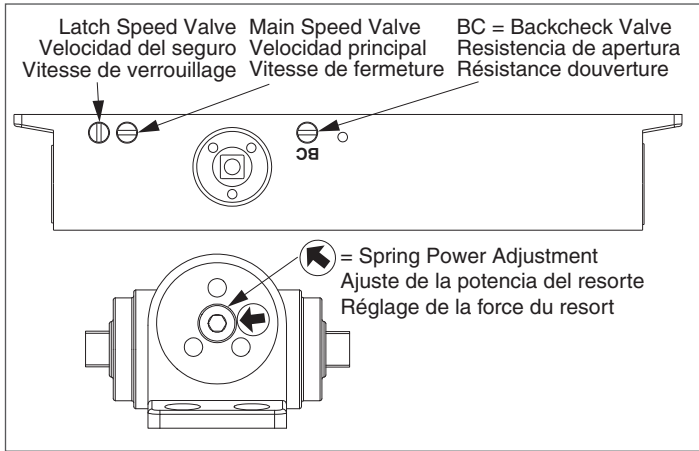

Parallel Arm Installation Instalación "brazo paralelo" Installation "bras parallèle"

Closer mounted on the push side of the door (opposite of the hinge side).
Cerrador montado al lado del empuje de la puerta (opuesto al lado del gozne).
Ferme-porte installé sur le côté à pousser de la porte (à l'opposé du côté de la charnière).

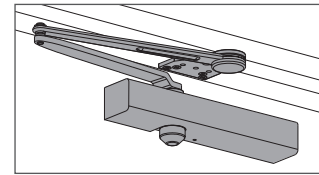

Optional Opcional Optionnelle

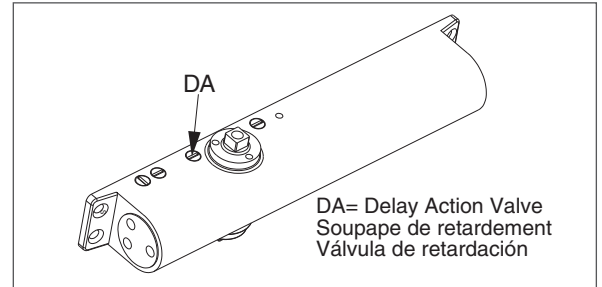

	Fasteners	Door/Frame	Drill Sizes
Arm Shoe	#14 Wood	Wood	1/8"
	1/4-20 Machine	Metal	Drill: #7 Tap: 1/4-20
Closer Body	#14 Wood	Wood	1/8"
	1/4-20 Machine	Metal	Drill: #7 Tap: 1/4-20
	Thru-Bolt	All	3/8"
Fifth Hole Spacer	#14 Wood	Wood	1/8"
	1/4-20 Machine	Metal	Drill: #7 Tap: 1/4-20

CAUTION

Improper installation or regulation may result in personal injury or property damage. Follow all instructions carefully. For questions, call Falcon at 1-877-671-7011

DANGER

Une installation ou un réglage inadéquats peuvent entraîner des blessures ou des dommages. Veuillez suivre toutes les instructions avec soin. Pour plus de renseignements, composez le 1-877-671-7011

ADVERTENCIA

Una instalación o un ajuste incorrectos pueden resultar en daño personal o material. Siga bien todas las instrucciones. Para más informaciones, llama a Falcon al 1-877-671-7011

Customer Service Servicio al cliente Service à la clientèle
1-877-671-7011 www.allegion.com/us



© Allegion 2014
Printed in U.S.A.
43035 Rev. 01/14-d

1 Door and frame preparation
Preparación de la puerta y del cuadro
Préparation de la porte et du cadre

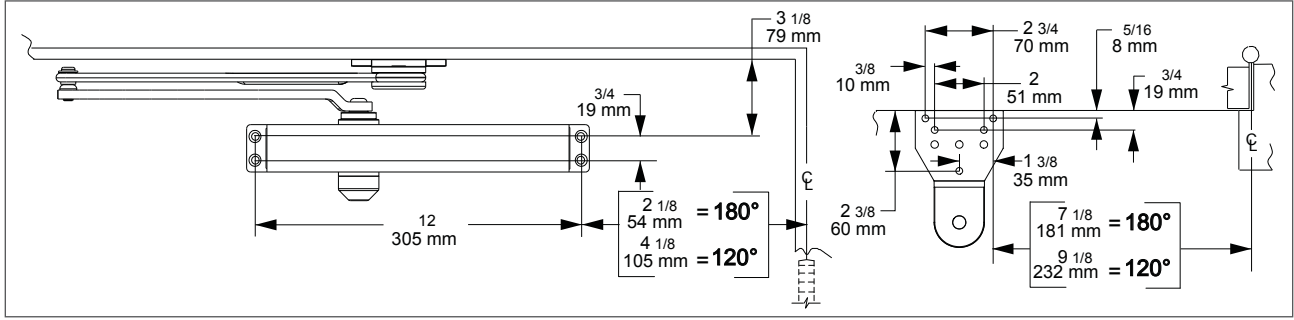

Right hand door illustrated. Same dimensions apply for left hand door measured from hinge side.
Montaje de puerta a la derecha como ilustrado. Las mismas dimensiones se aplican para un montaje de puerta a la izquierda medidas a partir del lado del gozne.
Porte main droite illustrée. Les mêmes dimensions s'appliquent pour une porte main gauche mesurées à partir du côté de la charnière.

2 Determine door width, adjust spring power to match chart
Determina la anchura de la puerta. Ajuste la potencia del resorte según lo indicado en el gráfico
Mesurez la largeur de la porte. Réglez le ressort selon les indications du tableau

	SC81 (1-6)
	0
30"- 750mm	+ 3
32"- 815mm	+ 6
36"- 915mm	+ 9
42"- 1050mm	+ 12
48"- 1220mm	+ 15

3 Disconnect arm & shoe assembly from main arm
Desconecte el ensamblaje del brazo y de la zapata del brazo principal
Séparez l'assemblage du bras et de la console du bras principal

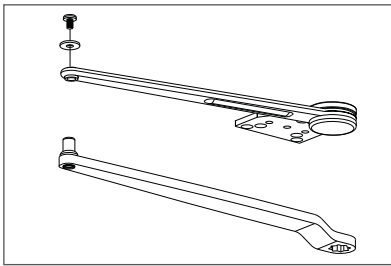

4 Install arm & shoe assembly onto frame
Instale el ensamblaje del brazo y de la zapata en el cuadro
Installez l'assemblage du bras et de la console sur le cadre

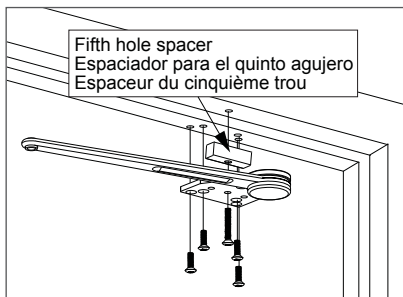

5 Install closer onto door
Monte el cerrador en la puerta
Installez le ferme-porte sur la porte

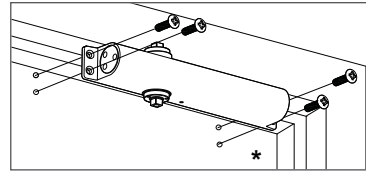

* Spring power faces toward the hinge edge.
* Potencia del resorte cara hacia el borde del gozne.
* Force du ressort fait face vers le bord de la charnière.

6 Attach main arm to closer
Coloque el brazo principal al cerrador
Attachez le bras principal au ferme-porte

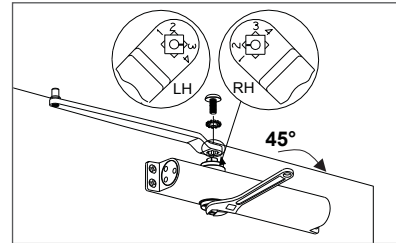

7 Connect arm pieces
Conecte las partes del brazo
Réunissez les sections de bras

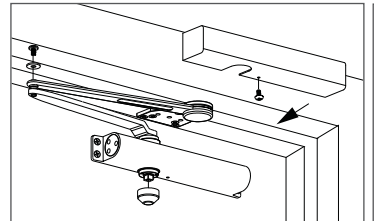

Attach pinion cap and slim cover (cap not used with full cover).
Sujete el capuchón y la cubierta delgada (no se usa la tapita con la tapa completa).
Attachez le capuchon et le couvercle mince (le capuchon nest pas utilisé avec le couvercle complet).

8 Adjustment instructions
Instrucciones de ajuste
Instructions de réglage

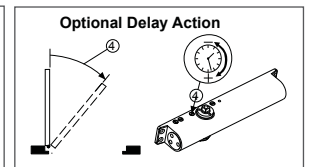
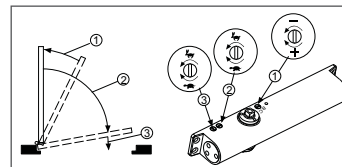

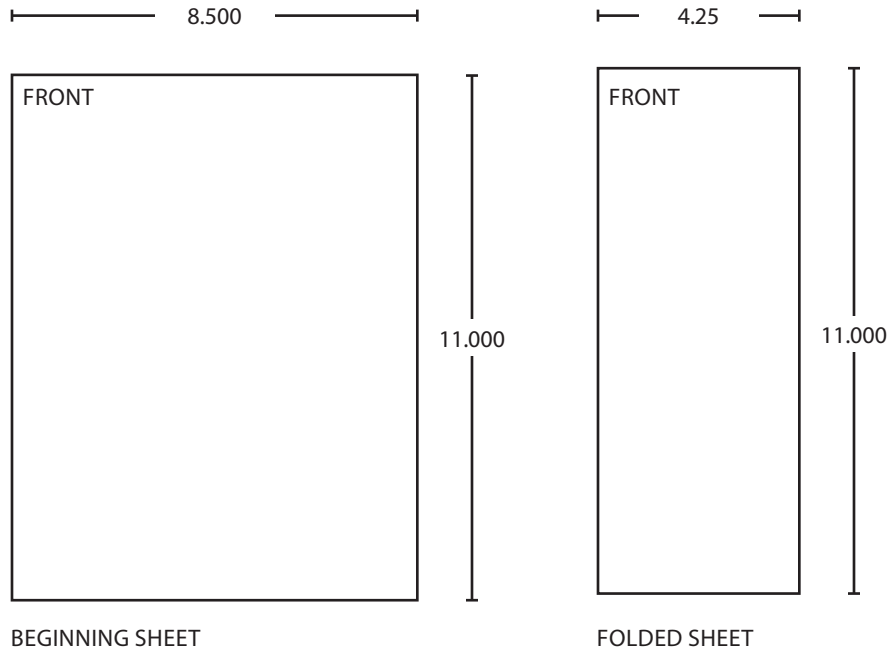

Additional Notes:
1. None

Revision History						Revision Description:					
A	B	C	D	E	F	D > Revised artwork					
N/A	N/A	N/A	046206								
Material						Edited By		Approved By		EC Number	Release Date
White Paper						D. Myers		M. Sasso		046206	01-01-14
Notes						Title					
1. printed two sides						SC80 Series Heavy Duty Arms Instruction Sheet					
2. printed black						Creation Date		Number			Revision
3. tolerance ± .13						04-27-10		43035			D
4. printed in country may vary						Created By		Activity		© Allegion 2014	
5. drawings not to scale						N/A		3899 Hancock Expwy Security, CO 80911			
						Software: InDesign CS6					