

1

MARK DOOR

Recommended template instructions must be followed to assure proper functioning. (See attached template).

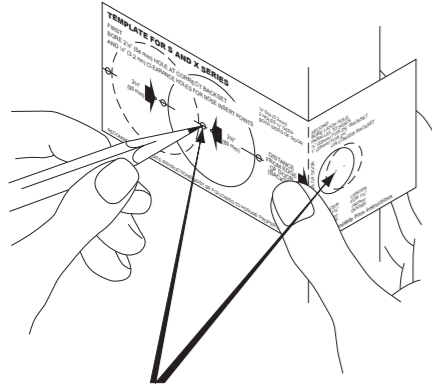

Mark centers for latch hole, side hole and rose insert points on both sides of door.

2

BORE 3 HOLES

A. Bore side hole from both sides of door.

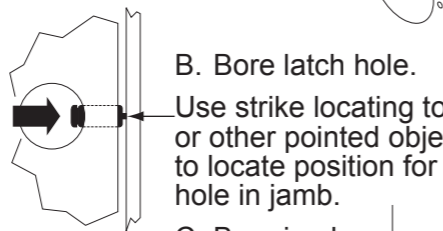

B. Bore latch hole.

Use strike locating tool or other pointed object to locate position for hole in jamb.

C. Bore jamb.

NOTE: A minimum 3/4" deep hole must be bored in frame behind opening in strike for proper function of latch bolt.

Outline latch face and strike as illustrated and chisel out to proper depth.

3

INSTALL LATCH AND STRIKE

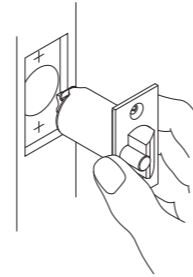

Install latch. Be sure beveled side of latch bolt is facing the door frame.

If dust box is to be used, clear area with wood chisel.

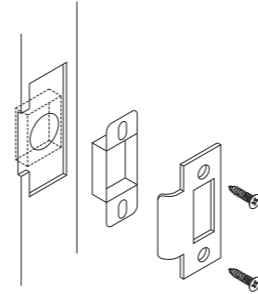

4

REMOVE INSIDE TRIM

Depress knob catch to remove knob.

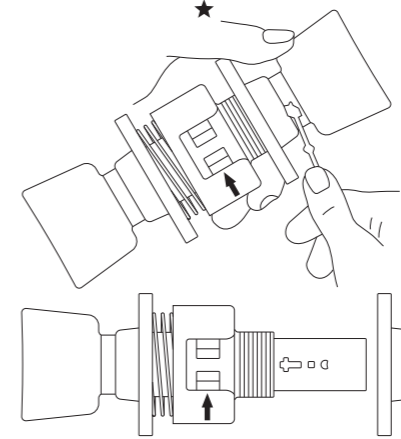

Remove rose by unscrewing collar. ★ If Cylinder knob, see reverse side.

5

ADJUST FOR DOOR THICKNESS

Hold lock against edge of door. Adjust outer rose collar so door center mark on lock housing is in center of door.

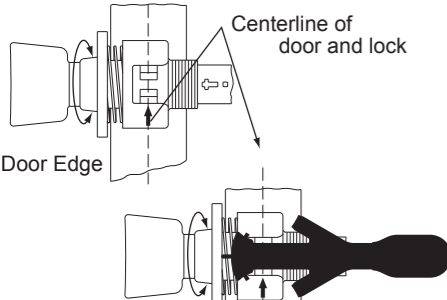

ALTERNATE METHOD

Wrench can be used to adjust lock for door thickness by holding tip of wrench against rose insert and turning rose collar until desired arrow on wrench lines up with arrow on lock case.

6

ENGAGE LOCK WITH LATCH

Both latch prongs engage housing.

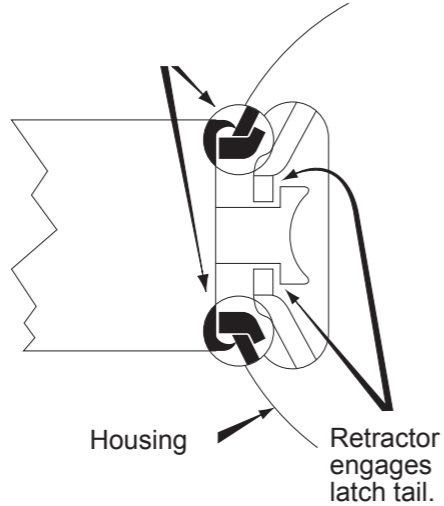

7

SECURE LOCK TO DOOR

Replace inside rose and collar and using spanner wrench turn collar clockwise and tighten firmly.

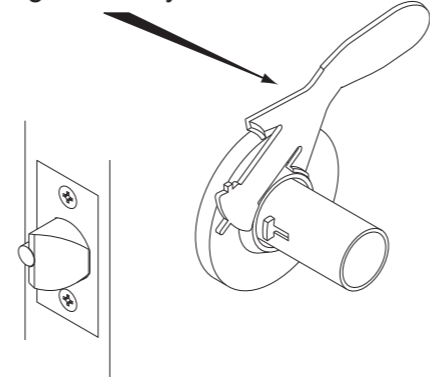

8

INSTALL KNOB

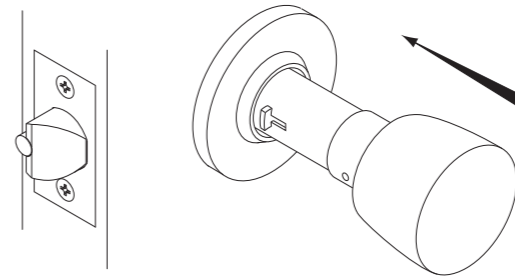

Place knob on spindle, slide to knob catch, depress knob catch and push knob until catch engages slot in knob. ★ If cylinder knob, see reverse side.

TEMPLATE FOR S AND X SERIES

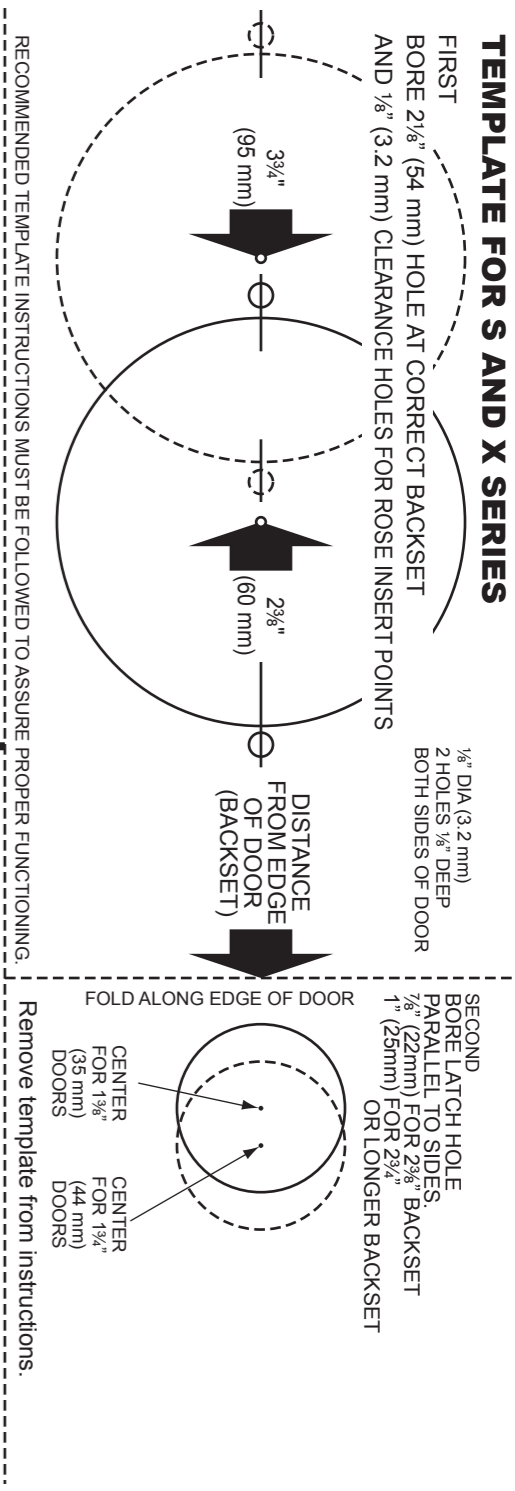

RECOMMENDED TEMPLATE INSTRUCTIONS MUST BE FOLLOWED TO ASSURE PROPER FUNCTIONING.

Remove template from instructions.

TEMPLATE FOR S AND X SERIES

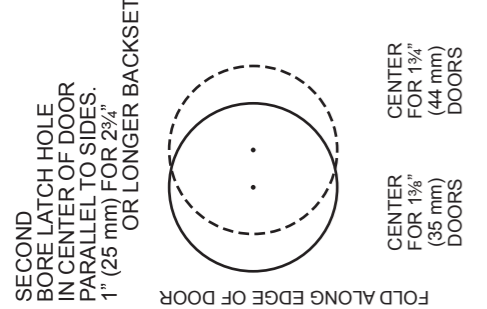
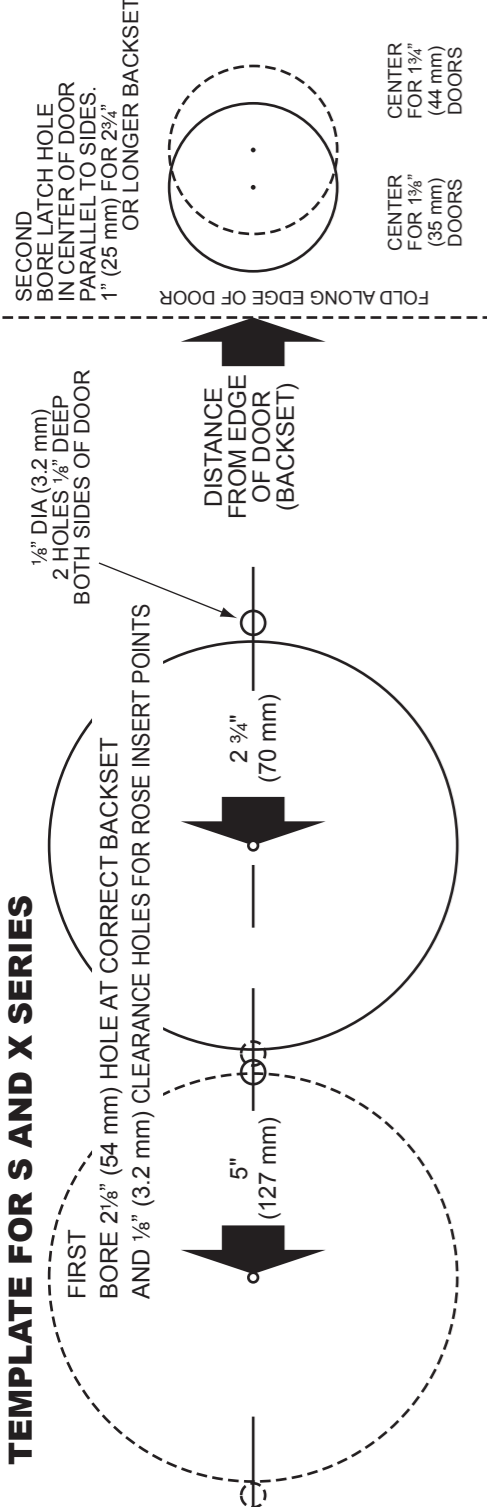

RECOMMENDED TEMPLATE INSTRUCTIONS MUST BE FOLLOWED TO ASSURE PROPER FUNCTIONING.

LITHO IN U.S.A.

INSTRUCTIONS FOR REMOVAL OF AND REASSEMBLY OF CYLINDER KNOB

Cylinder knob should be installed as shown. (key notches up)

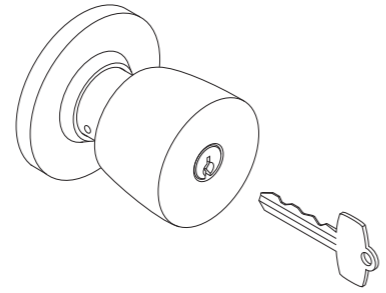

If necessary to change hand of lock so that cylinder will be right side up, use the following instructions:

TO REMOVE CYLINDER KNOB

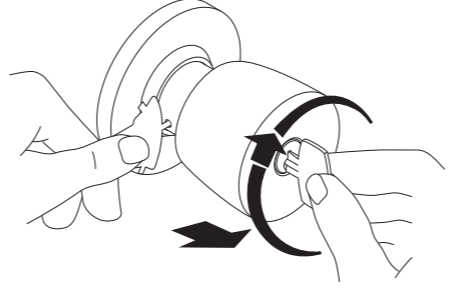

Assembly not installed in door: Rotate key 1/4 turn clockwise, depress knob catch and pull off knob. Rotate housing 180° and reinstall cylinder knob.
 Assembly installed in door: Rotate key 1/4 turn clockwise, depress knob catch and pull off knob. Rotate knob 180° and reinstall cylinder knob.

TO INSTALL CYLINDER KNOB

STEP ONE

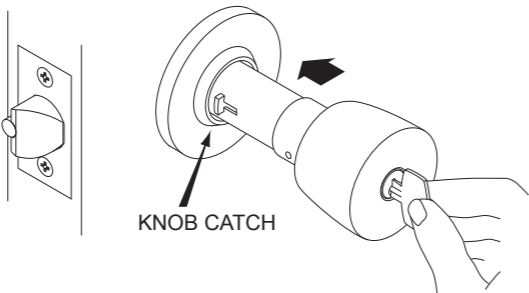

With key in cylinder, align hole in knob cap with knob catch and slip knob over spindle up to knob catch.

STEP TWO

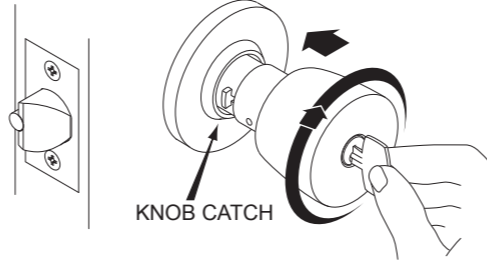

With knob against knob catch, and cylinder tailpiece engaged with key spindle, hold knob, rotate key 1/4 turn clockwise. Depress knob catch and push knob until catch engages slot in knob.

HOW TO INSTALL S SERIES AND X SERIES FALCON LOCKS

FALCON®

HOW TO INSTALL S SERIES AND X SERIES FALCON LOCKS

FALCON®



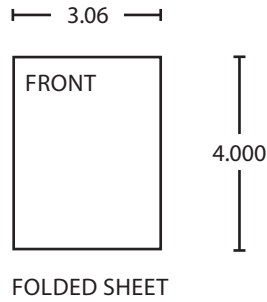
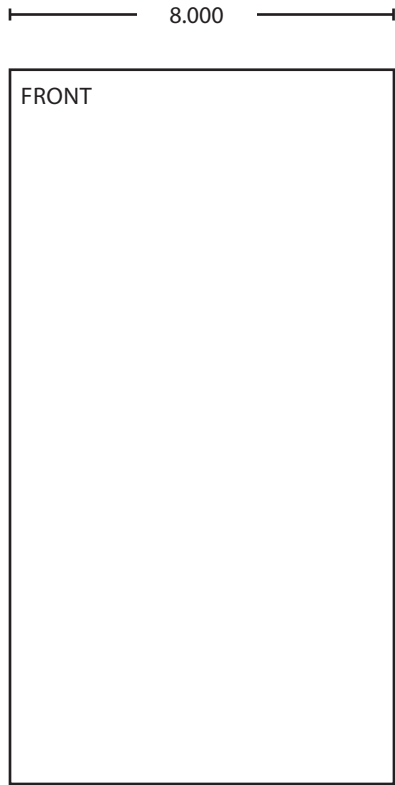

Additional Notes:
1. None

Revision History						Revision Description:						
A	B	C	D	E	F	D > Revised artwork						
4526	0790	6683										
Material						Edited By		Approved By		EC Number	Release Date	
White Paper						J. Ellis		M. Roberts		xxxxx	10/14	
Notes 1. printed two sides 2. printed black 3. tolerance ± .13 4. printed in country may vary 5. ok to fold into uneven sections 6. barcode shows after folding						Title						
						Sheet Instruction, S & X						
						Creation Date		Number			Revision	
						10-22-14		002290-000-70			D	
Created By				Activity		© Allegion 2014						
J. Ellis				3899 Hancock Expwy Security, CO 80911								
Software: InDesign CS6												