



Residential Price Book 14

Effective March 1, 2024





TRUSTED IN OVER
40 MILLION
HOMES

Trust your home to Schlage.

For more than a century, Schlage has helped protect what matters most – peace of mind. Our long-standing commitment to transforming the industry is evidenced through our products, partners, software solutions, and brand DNA. Trusted in over 40 million homes, we strive to enhance everyday life by delivering door hardware and access control solutions focused on reliable experiences, modern simplicity, thoughtful innovation, and a dedication to craftsmanship. Where some see just a door, we see an opportunity to help our partners turn homes into havens. Trust your homes to Schlage.



Quickly install Schlage products with just a Phillips screwdriver

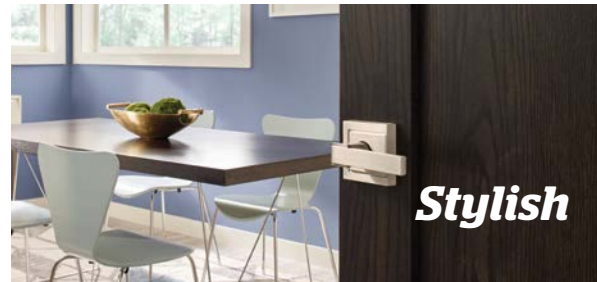

Choose from a range of lever, knob and trim styles to instantly elevate any room



Built with premium metal construction that adds strength, security and long life



Products feature advanced technology to keep the state-of-the-art moving forward

Electronic Locks

- Connected deadbolts and levers7
 - Available functions7
 - Product identification7
 - Finish codes and descriptions.7
 - Latches and strikes7
 - Standard features/configurations8
 - Packaging and carton specs8
 - BE499WB Series Schlage Encode Plus™ Smart WiFi Deadbolt.9
 - BE489WBC Series Schlage Encode™ Smart WiFi Deadbolt.9
 - FE789WBC Series Schlage Encode™ Smart WiFi Lever.10
 - BE469ZP Series Schlage Connect® Smart Deadbolt.11
 - BE468ZP Series Schlage Connect® Smart Deadbolt.11
 - J Series by Schlage Connected Lock12
- Code entry locks13
 - Standard features/configurations14
 - Latches and strikes14
 - Packaging and carton specs15
 - Schlage Touch® Deadbolts16
 - Schlage Touch® Levers17
 - Keypad deadbolts.18
 - Keypad Entry with Flex-Lock.19
 - Keypad Entry with Auto-Lock20

Handlesets

- F Series21
 - Available functions21
 - Product identification21
 - Latches and strikes21
 - Standard features/configurations22
 - Finish codes and descriptions.22
 - Packaging and carton specs22
 - Available styles23
 - Pricing24
 - F Series Decorative collection.28
- J Series29
 - Available functions29
 - Product identification29
 - Standard features/configurations30
 - Finish codes and descriptions.30
 - Packaging and carton specs30
 - Pricing31

Levers

- F Series33
 - Available functions33
 - Product information33
 - Latches and strikes33
 - Standard features/configurations34
 - Finish codes and descriptions.34
 - Packaging and carton specs34
 - Available styles35
 - Pricing36
 - F Series Decorative collection.43
- J Series44
 - Available functions44
 - Product identification44
 - Latches and strikes44
 - Standard features/configurations45
 - Finish codes and descriptions.45
 - Packaging and carton specs45
 - Pricing46

Knobs

F Series50
 Available functions50
 Product identification50
 Latches and strikes50
 Standard features/configurations51
 Finish codes and descriptions.51
 Packaging and carton specs51
 Available styles52
 Pricing53
 F Series Decorative collection.57
 J Series58
 Available functions58
 Product identification58
 Latches and strikes58
 Standard features/configurations59
 Finish codes and descriptions.59
 Packaging and carton specs59
 Pricing60

Deadbolts

B Series62
 Available functions62
 Product identification62
 Latches and strikes62
 Standard features/configurations63
 Finish codes and descriptions.63
 Packaging and carton specs63
 Pricing64
 B Series Decorative collection65
 J Series67
 Available functions67
 Product identification67
 Latches and strikes67
 Standard features/configurations68
 Finish codes and descriptions.68
 Packaging and carton specs68
 Pricing69

Hardware & Accessories

Builder's hardware71
 Barn door hardware72
 Door hinges73
 Door stops74
 Pocket door hardware.75
 Mail slots, viewers & door knockers76
 Classic house numbers77
 Push, pull & kick plates79
 Hooks80
 Handrail brackets81
 Window hardware, flush pulls.82
 Parts.83
 Latch & strike quick reference guide.83
 F Series Latches84
 F Series Strikes87
 Cylinders.89
 Assembly screw kits90
 Thick door installation kits91
 FC Series Miscellaneous parts91
 Miscellaneous parts91
 Discontinued lock parts91
 Key & cylinder stamping.93
 Residential master & construction keying.93
 Construction core program.95
 J Series Latches.96
 J Series Strikes97

Cables, Chains & Padlocks

Padlocks101
 Cables & chains.102
 Security hasps104

How to Order

How to order105
Retail pack carton specifications106

Policies and documents

The purchase of Allegion products is governed by the Allegion Authorized Seller Program. For program terms and conditions, and other program details, please visit: www.allegion.com/AuthorizedSeller.

For Warranty information, visit us.allegion.com/warranty or contact Customer Service at 800.900.4734.

Connected Deadbolts & Levers 7
 Code Entry Locks 13

Connected Deadbolts & Levers

AVAILABLE FUNCTIONS

Deadbolts & Levers



BE499

BE489WBC



FE789WBC



BE469ZP

BE468ZP

BE499 SCHLAGE ENCODE™ PLUS SMART WIFI DEADBOLT

- With Apple® Home Keys, you can simply tap to lock or unlock using your iPhone® or Apple Watch® for easy and secure access to your home
- Schlage's next generation smart lock offers unparalleled flexibility with new capabilities that provide even greater convenience and security for home access control
- Built-in WiFi, no hub required. Works with Schlage Home app, Yonomi app, Amazon Alexa, Google Assistant™
- Multiple access methods including access codes, smart phone, virtual keys, voice and Apple Home key
- ANSI/BHMA A156.36 Commercial Grade 1
- ANSI/BHMA 156.40-2015 Residential Grade AAA
- UL Listed for 20-minute fire door.

BE489 - SCHLAGE ENCODE™ SMART WIFI DEADBOLT

- Secure, remote access from anywhere - no hubs or adapters required
- Seamlessly integrates with other smart technology in your home
- Works with Schlage Home app, Yonomi app, Amazon Alexa, Google Assistant
- ANSI/BHMA A156.36 Commercial Grade 1
- ANSI/BHMA 156.40-2015 Residential Grade AAA
- UL Listed for 20 minute fire door

FE789WBC - SCHLAGE ENCODE™ SMART WIFI LEVER

- Secure, remote access from anywhere - no hubs or adapters required
- Seamlessly integrates with other smart technology in your home
- Works with Schlage Home app, Yonomi app, Amazon Alexa, Google Assistant
- ANSI/BHMA A156.36 Commercial Grade 1
- ANSI/BHMA 156.40-2015 Residential Grade AAA
- UL Listed for 20 minute fire door

BE469 - SCHLAGE CONNECT™ SMART DEADBOLT WITH ALARM

- Uses Z-Wave Plus® to connect to an existing smart home or security system
- Includes a built-in alarm that detects activity at the door
- ANSI/BHMA A156.36-2010 Commercial Grade 1
- ANSI/BHMA 156.40-2015 Residential Grade AAA
- Auto Lock capability when programmed

BE468 - SCHLAGE CONNECT™ SMART DEADBOLT

- Uses Z-Wave® Plus to connect to an existing smart home or security system
- ANSI/BHMA A156.36-2010 Commercial Grade 2
- ANSI/BHMA 156.40-2015 Residential Grade BAA

PRODUCT IDENTIFICATION

BE	469ZP	V	CAM	619	12-342	10-116
Lock Series	Product	Vis Pack	Style	Finish Code	Latch	Strike

FINISH CODES & DESCRIPTIONS

505	530	605	608	609	618	619	620	621	622	625	626	716
Lifetime Bright Brass	Black Stainless	Bright Brass (US3)	Satin Brass	Antique Brass (US5)	Polished Nickel	Satin Nickel (US15)	Antique Pewter (US15A)	Distressed Nickel	Matte Black (US19)	Bright Chrome (US26)	Satin Chrome (US26D)	Aged Bronze

Non-standard finishes are not available.
 Full-color swatch examples available on inside Electronics tab.

LATCHES & STRIKES

Latches

Motorized Deadbolt Latches

12-342 - Tapered Deadbolt Dual Option (Round, Drive-in) - **STANDARD**

12-344 - Tapered Deadbolt Triple Option (Round, Square, Drive-in)

Motorized Deadbolt Entry Set Latches

16-264 - Combo Taper Deadbolt & Spring Latch Dual Option (Round, Drive-in) - **STANDARD**

Non-Motorized Deadbolt Latches

12-321 - Dual Option (Round, Drive-in) - **STANDARD**

12-287 - Triple Option (Round, Square, Drive-in)

Keyed Latches - Dead Latches

16-086 - Dual Option (Round, Drive-in) - **STANDARD**

16-211 - Triple Option (Round, Square, Drive-in)

Strikes

Deadbolt Strikes

10-116 - Round Corner Integrated Strike and Reinforcer - **STANDARD**

Deadbolt Entry Set Strikes

10-115 - Round Corner Full Lip Strike Set - **STANDARD**

Lever Strike

10-027 - Round Corner Full Lip Strike - **STANDARD**



STANDARD FEATURES / CONFIGURATIONS

	Schlage Encode™ Plus BE499WB	Schlage Encode™ BE489WBC	Schlage Encode™ Smart WiFi Lever FE789WBC	Schlage Connect® BE469ZP	Schlage Connect® BE468ZP	J Series by Schlage Connected JBE109/JFE109
Certification:	ANSI/BHMA A156.36 Commercial Grade 1 ANSI/BHMA 156.40-2015 Residential Grade AAA UL Listed in the US for 20 minute fire door. No hose.	ANSI/BHMA A156.36 Commercial Grade 1 ANSI/BHMA 156.40-2015 Residential Grade AAA UL Listed in the US for 20 minute fire door. No hose.	Commercial Grade 1 ANSI/BHMA 156.39-2020 Residential Grade AAA UL Listed in the US for 20 minute fire door. No hose.	ANSI/BHMA A156.36-2010 Commercial Grade 1 ANSI/BHMA 156.40-2015 Residential Grade AAA	ANSI/BHMA A156.36-2010 Commercial Grade 2 ANSI/BHMA 156.40-2015 Residential Grade BAA	ANSI/BHMA Commercial Grade 2 ANSI/BHMA Residential Grade AAA
Product Dimensions: (w x h x d)	ext: 3" x 5" x 0.9" int: 3" x 5.5" x 2.2"	ext: 3" x 5" x 0.9" int: 3" x 5.5" x 2.2"	ext: 3" x 5-7/8 x 3" int: 3" x 5.5" x 3"	ext: 3" x 5" x 1" int: 3" x 8" x 2"	ext: 3" x 5" x 1" int: 3" x 8" x 2"	2.68" x 5.15" x 1.25"
Weight:	3.4 lbs	3.4 lbs	4.25 lbs	3.5 lbs	3.5 lbs	5.7 lbs
Warranty:	3 year electronics, limited lifetime mechanical & finish	3 year electronics, limited lifetime mechanical & finish	3 year electronics, limited lifetime mechanical & finish	3 year electronics, limited lifetime mechanical & finish	3 year electronics, limited lifetime mechanical & finish	Limited lifetime mechanical, 5-year limited finish and 1-year limited electronic warranty
Battery:	AA batteries (4)	AA batteries (4)	AA batteries (4)	AA batteries (4)	AA batteries (4)	AA batteries (4)
Latch Throw:	1/2"	1/2"	1/2"	1"	1"	1"
Key & Cylinder:	1 key, 5-pin, C keyway	1 key, 5-pin, C keyway	1 key; 5-pin C keyway	1 key, 5-pin, C keyway	1 key, 5-pin, C keyway	1 key; 5-pin C keyway
Key Options:	50-223 Residential Master Key, 50-224 Residential Construction Key	50-223 Residential Master Key, 50-224 Residential Construction Key	50-223 Residential Master Key, 50-224 Residential Construction Key	50-223 Residential Master Key, 50-224 Residential Construction Key	50-223 Residential Master Key, 50-224 Residential Construction Key	50-223 Residential Master Key, 50-224 Residential Construction Key
Door Thickness:	1-3/8" to 1-3/4"; Thick door kit extends 1-7/8" to 2-1/2"	1-3/8" to 1-3/4"; Thick door kit extends 1-7/8" to 2-1/2"	1-3/8" to 1-3/4"	1-3/8" to 1-3/4"; Thick door kit extends 1-7/8" to 2-1/2"	1-3/8" to 1-3/4"; Thick door kit extends 1-7/8" to 2-1/2"	1-3/8" to 2"
Cross Bore Distance:	4" center-to-center minimum	4" center-to-center minimum	4" center-to-center minimum	4" center-to-center minimum	4" center-to-center minimum	4" center-to-center minimum
Cross Bore Diameter:	1-1/2" or 2-1/8"	1-1/2" or 2-1/8"	2-1/8"	1-1/2" or 2-1/8"	1-1/2" or 2-1/8"	2-1/8"
Edge Bore Diameter:	1"	1"	1"	1"	1"	1"
Backset:	2-3/8" or 2-3/4"	2-3/8" or 2-3/4"	2-3/8" or 2-3/4"	2-3/8" or 2-3/4"	2-3/8" or 2-3/4"	2-3/8" to 2-3/4" adjustable
Faceplate Size:	1" x 2-1/4"	1" x 2-1/4"	1" x 2-1/4"	1" x 2-1/4"	1" x 2-1/4"	1" x 2-1/4"
Faceplate Options:	Round corner, square corner, and drive-in (triple option standard)	Round corner, square corner, and drive-in (triple option standard)	Round corner, square corner, and drive-in (triple option standard)	Round corner, square corner, and drive-in (dual option standard)	Round corner, square corner, and drive-in (dual option standard)	Radius deadbolt strike
Strike:	1-1/8" x 2-3/4" round corners, strike reinforcer	1-1/8" x 2-3/4" round corners, strike reinforcer	2-1/4" x 1-5/8" dual strikes	1-1/8" x 2-3/4" round corners, strike reinforcer	1-1/8" x 2-3/4" round corners, strike reinforcer	1" x 2-1/4"; Lever - radius full lip strike 1-1/2" x 2-3/4"
Codes:	Pre-set, unique 6 digit programming code, 2 pre-set unique 4-digit access codes, 100 access code capacity	Pre-set, unique 6 digit programming code, 2 pre-set unique 4-digit access codes, 100 access code capacity	Pre-set, unique 6 digit programming code, 2 pre-set unique 4-digit access codes, 100 access code capacity	Pre-set, unique 6-digit programming code, two pre-set unique 4-digit access codes, 30 code capacity	Pre-set, unique 6-digit programming code, two pre-set unique 4-digit access codes, 30 code capacity	2 pre-set unique user codes, storage of up to 10 user codes
Communications:	WiFi	WiFi	WiFi	900 MHz (Z-Wave® RF)**	900 MHz (Z-Wave® RF)**	900 MHz (Z-Wave® RF)**
Operating Temps:	Ext: -35°C to 66°C Int: -10°C to 49°C	Ext: -35°C to 66°C Int: -10°C to 49°C	Ext: -35°C to 66°C Int: -10°C to 49°C	Ext: -30°C to 66°C Int: -10°C to 49°C	Ext: -30°C to 66°C Int: -10°C to 49°C	Ext: -35°C to 66°C Int: 0°C to 49°C

** The Bluetooth® word mark and logos are registered trademarks owned by Bluetooth SIG, Inc. and any use of such marks by Schlage Lock Company, LLC is under license. HomeKit™ is a trademark of Apple Inc.

PACKAGING & CARTON SPECS

	INDIVIDUAL CARTON				SHIPPER					
	CARTON WEIGHT	HEIGHT	WIDTH	DEPTH	QTY. SHIPPER	CARTON WEIGHT	CU. FT.	HEIGHT	WIDTH	DEPTH
BE489	3.4 lbs	4.53 in.	9.10 in.	4.95 in.	4	14.2 lbs		9.5 in.	9.375 in.	10.25 in.
BE499	3.4 lbs	4.53 in.	9.10 in.	4.95 in.	4	14.2 lbs		9.5 in.	9.375 in.	10.25 in.
BE469	3.8 lbs	9.25 in.	5.125 in.	4.5 in.	4	16.0 lbs	0.58	10.0 in.	9.625 in.	10.5 in.
BE468	3.8 lbs	9.25 in.	5.125 in.	4.5 in.	4	16.0 lbs	0.58	10.0 in.	9.625 in.	10.5 in.
BE469	3.6 lbs	4.53 in.	9.19 in.	4.5 in.	4	15 lbs	0.58	9.5 in.	9.375 in.	10.25 in.
FE789	3 lbs	9.3 in.	5.1 in.	8.5 in.	4	14 lbs		10.17 in.	10.82 in.	17.57 in.

For Vis Pack carton specs, see page 106.



Schlage Encode Plus™ Smart WiFi Deadbolt



ACCESS MADE SIMPLE AND SECURE

- Schlage’s next generation smart lock offers unparalleled flexibility with new capabilities that provide even greater convenience and security for home access control
- First major North American lock brand to support new home keys for iPhone® and Apple Watch® (requires iOS 15/Watch OS 8 or newer)
- No Apple hub required to use home keys
- Apple HomeKit® experience: lock and unlock from iPhone or Apple Watch, status, Siri® voice control
- Remote connectivity & automations through HomeKit require an Apple Home hub
- Built-in WiFi, no hub required

BE499WB

Schlage Encode Plus™ Smart WiFi Deadbolt

FINISHES

Style/Design	Packaging	605	505	530	608	609	618	619	620	621	622	625	626	716
(CAM) Camelot	Box / Vis	•	•	\$816	•	•	•	\$816	•	•	\$816	\$816	•	\$816
(CEN) Century	Box / Vis	•	•	\$816	•	•	•	\$816	•	•	\$816	\$816	•	\$816

Schlage Encode™ Smart WiFi Deadbolt



PEACE OF MIND FROM ANYWHERE

- Secure remote access from anywhere - no hubs or adapters required
- Smaller interior trim offers more stylish aesthetic
- Works with Schlage Home app, Yonomi app, Amazon Alexa, Google Assistant™
- Firmware updates through the app ensure future compatibility

BE489WBC

Schlage Encode™ Smart WiFi Deadbolt

FINISHES

Style/Design	Packaging	605	505	530	608	609	618	619	620	621	622	625	626	716
(CAM) Camelot	Box / Vis	•	•	\$707	•	•	•	\$707	•	•	\$707	\$707	•	\$707
(CEN) Century	Box / Vis	•	•	\$707	\$707	•	•	\$707	•	•	\$707	\$707	•	\$707
(GRW) Greenwich	Box / Vis	•	•	•	\$707	•	•	\$707	•	•	\$707	\$707	•	\$707

Item Number	Description
B489-010-CAM	Cover, Battery, Inside, Camelot
B489-010-CEN	Cover, Battery, Inside, Century
B489-011	Battery, Holder
B489-108	Kit, Screws, BE489
B489-106	Thick Door Kit, BE489

Call for availability

List Price Adders:

Visual Package Options (highlighted) - add \$7 to list price



Schlage Encode™ Smart WiFi Lever



FE789WBC
Camelot x Accent
(CAM) (ACC)



FE789WBC
Century x Latitude
(CEN) (LAT)

FE789WBC

Schlage Encode™ Smart WiFi Lever

FINISHES

Function	Style/Design	Packaging	605	505	530	608	609	618	619	620	621	622	625	626	716
(CAM) Camelot															
FE789WBC	Accent	Box / Vis	•	•	\$777	•	•	•	\$777	•	•	\$777	\$777	•	\$777
FE789WBC	Avila	Box	•	•	\$777	•	•	•	\$777	•	•	\$777	\$777	•	\$777
(CEN) Century															
FE789WBC	Elan	Box	•	•	\$777	•	•	•	\$777	•	•	\$777	\$777	•	\$777
FE789WBC	Latitude	Box / Vis	•	•	\$777	•	•	•	\$777	•	•	\$777	\$777	•	\$777

List Price Adders:

Visual Package Options (highlighted) - add \$7 to list price

Schlage Connect® Smart Deadbolt

BE469ZP Features:

- ANSI/BHMA Commercial Grade 1 Security Rating
- ANSI/BHMA Residential Grade AAA in Security, Durability, Finish
- Alarm function



BE469ZP
Camelot
(CAM)

BE469ZP
Century
(CEN)

**BE469ZP Series
Schlage Connect®**

Function	Packaging	FINISHES												
		605	505	530	608	609	618	619	620	621	622	625	626	716
BE469ZP Camelot	Box/Vis	\$592	•	\$599	•	•	•	\$599	•	•	\$599	\$599	•	\$599
BE469ZP Century	Box/Vis	•	•	\$599	•	•	•	\$599	•	•	\$599	\$599	\$599	\$599

List Price Adders:

Visual Package Options (highlighted) - add \$7.00 to list price.
 Triple Option Latch - add \$3.00 to list price.
 Split Finish - add \$8.00 to highest list price.

BE468ZP Features:

- ANSI/BHMA Commercial Grade 2 Security Rating
- ANSI/BHMA Residential Grade BAA in Security, Durability, Finish
- White backlighting
- No alarm function



BE468ZP
Camelot
(CAM)

BE468ZP
Century
(CEN)

**BE468ZP Series
Schlage Connect®**

Function	Packaging	FINISHES												
		605	505	530	608	609	618	619	620	621	622	625	626	716
BE468ZP Camelot		\$525	•	\$534	•	•	•	\$534	•	•	\$534	\$534	•	\$534
BE468ZP Century		•	•	\$534	•	•	•	\$534	•	•	\$534	\$534	\$534	\$534

List Price Adders:

Visual Package Options (highlighted) - add \$7.00 to list price.
 Triple Option Latch - add \$3.00 to list price.
 Split Finish - add \$8.00 to highest list price.



JBE109

J Series by Schlage Connected Deadbolt

FINISHES

Function	Packaging	605	505	530	608	609	618	619	620	621	622	625	626	716
JBE109 Billows	Box	•	•	•	•	•	•	\$370	•	•	•	•	•	\$370
JBE109 Gatlin	Box	•	•	•	•	•	•	\$370	•	•	•	•	•	\$370

JFE109

J Series by Schlage Connected Lever

FINISHES

Function	Packaging	605	505	530	608	609	618	619	620	621	622	625	626	716
JFE109 Billows	Box	•	•	•	•	•	•	\$405	•	•	•	•	•	\$405
JFE109 Gatlin	Box	•	•	•	•	•	•	\$405	•	•	•	•	•	\$405

Available in graphic carton only.

Code Entry Locks

AVAILABLE FUNCTIONS



BE375



FE695

Schlage Touch™ Locks
ANSI/BHMA Commercial Grade 2
ANSI/BHMA Residential Grade AAA

BE375 – Touchscreen Deadbolt

- Deadbolt retracted by entering valid user code then rotating outside thumbturn, or by inside thumb turn
- Deadbolt thrown by rotating outside thumbturn after pressing Schlage button, or by inside thumbturn

FE695 – Touchscreen Lever

- Unlocked from outside by valid access code
- Inside knob or lever always unlocked
- Interior switch sets lock to unlocked or automatic re-locking modes



BE365



FE595

Keypad Locks
ANSI/BHMA Commercial Grade 2

BE365 - Keypad Deadbolt

- Deadbolt thrown from outside by keyway turn after pressing Schlage button or by inside thumbturn
- Deadbolt retracted from outside by entering valid access code then rotating keyway turn or by inside thumbturn
- Key can be used to unlock as backup
- Options available for UL Listed 20 min fire door (no hose) and 3 hour fire door.

FE595 - Keypad Entry with Flex-Lock

- Flex-locking, use interior switch to change between unlocked or automatic re-locking modes
- Unlocked by valid access code from outside
- Inside knob or lever always unlocked
- Key can be used to unlock as back-up

FE575 - Keypad Entry with Auto-Lock

- Auto-locking, automatically re-locks after 5 seconds
- Unlocked by valid access code from outside
- Inside knob or lever always unlocked
- Key can be used to unlock as back-up



FE575

NOTE:
 FE285 is now located in the
 Handleset section of the pricebook.

PRODUCT IDENTIFICATION

FE	595		PLY	505	FLA		12-322	10-115	KD
Lock Series	Product	Suffix Package	Style	Finish Code	Design	Hand	Latch	Strike	Keying

FINISH CODES & DESCRIPTIONS

505	530	605	608	609	613	618	619	620	621	622	625	626	716
Lifetime Bright Brass	Black Stainless	Bright Brass (US3)	Satin Brass	Antique Brass (US5)	Oil-Rubbed Bronze (US10B)	Polished Nickel	Satin Nickel (US15)	Antique Pewter (US15A)	Distressed Nickel	Matte Black (US19)	Bright Chrome (US26)	Satin Chrome (US26D)	Aged Bronze

Non-standard finishes are not available.
 Full-color swatch examples available on inside Handleset tab.

Code Entry Locks

STANDARD FEATURES / CONFIGURATIONS

Certification	Schlage Touch™ Electronic Deadbolt BE375	Schlage Touch™ Electronic Lever FE695
	ANSI/BHMA Commercial Grade 2 ANSI/BHMA Residential Grade AAA	ANSI/BHMA Commercial Grade 2 ANSI/BHMA Residential Grade AAA
Product Dimensions (inches) (w x h x d)	3 x 5.4 x 5.2	3 x 5.375 x 6.75
Weight (lbs)	3.4 lbs	4.2 lbs
Warranty	3 year electronics, limited lifetime mechanical and finish	3 year electronics, limited lifetime mechanical and finish
Battery	9V battery (1)	9V battery (1)
Latch Throw	1"	1/2" throw, 7/8" housing diameter
Cylinder	None	None
Door Thickness	extends 1-3/8" to 1-3/4" 1-7/8" to 2-1/2"; thick door kit	1-3/8" to 1-3/4"
Cross Bore	2-1/8"	2-1/8"
Latch/Backset	2-3/8" to 2-3/4" adjustable	2-3/8" OR 2-3/4" adjustable
Latch Faceplate Size	1" x 2-1/4"	1" x 2-1/4"
Latch Faceplate Options	Spring latch radius corner and circular drive-in faceplates	Spring latch radius corner and circular drive-in faceplates
Strike	1-1/8" x 2-3/4" round corners, strike reinforce	1-5/8" x 2-1/4", radius corner, full lip latch strikes
Keys	None	None
Codes	2 pre-set unique 4-digit access codes, storage of up to 19 access codes	2 pre-set unique 4-digit access codes, storage of up to 19 access codes
Operating Temperatures	Outside lock body (exterior mounted): -35°C to 66°C Inside lock body (interior mounted): -10°C to 50°C	Outside lock body (exterior mounted): -35°C to 66°C Inside lock body (interior mounted): -10°C to 50°C

LATCHES & STRIKES

FE Keypad Levers

Keyed Latches - Dead Latches

16-086 - Dual Option (Round, Drive-in) - **STANDARD**

16-207 - Square Corner

16-211 - Triple Option (Round, Square, Drive-in)

Strikes

10-027 - Round Corner Full Lip - **STANDARD**

10-001 - Square Corner T Strike

10-026 - Square Corner Full Lip

10-058 - Circular - Adjustable

10-063 - Dual Strikes (Round & Square Full Lip)

10-025 - ANSI Square Corner

BE Keypad Deadbolts

Latches

12-321 - Dual Option (Round, Drive-in) - **STANDARD**

12-288 - Square Corner

12-287 - Triple Option (Round, Square, Drive-in)

12-294 - UL Listed Square Corner with Firecup

12-397 - UL Listed Round Corner with Firecup

Strikes

10-116 - Round Corner Integrated Strike and Reinforcer-
STANDARD

10-092 - Round Corner Full Lip Strike

10-147 - Square Corner Integrated Strike and Reinforcer

Code Entry Locks

STANDARD FEATURES / CONFIGURATIONS

Certification	Electronic Keypad Deadbolt BE365 ANSI/BHMA Commercial Grade 2 ANSI/ BHMA Residential Grade AAA Options available for UL Listed for 20-min fire door (no hose) and 3-hour fire door	Electronic Keypad Entry with Flex-Lock FE595 ANSI/BHMA Commercial Grade 2 ANSI/ BHMA Residential Grade AAA	Electronic Keypad Entry with Auto-Lock FE575 ANSI/BHMA Commercial Grade 2 ANSI/ BHMA Residential Grade AAA
Product Dimensions (inches) (w x h x d)	5.5 x 3.125 x 5.75	3 x 6.5 x 6.5	3 x 6.5 x 6.5
Weight (lbs)	3.8 lbs	3.4 lbs	3.4 lbs
Warranty	3 year electronics, limited lifetime mechanical and finish	3 year electronics, limited lifetime mechanical and finish	3 year electronics, limited lifetime mechanical and finish
Battery	9V battery (1)	9V battery (1)	9V battery (1)
Latch Throw	1"	1/2" throw, 7/8" housing diameter	1"
Cylinder	5-pin, C keyway	5-pin, C keyway	5-pin, C keyway
Key Options	50-223 Residential Master Key, 50-224 Residential Construction Key	50-223 Residential Master Key, 50-224 Residential Construction Key	50-223 Residential Master Key, 50-224 Residential Construction Key
Door Thickness	1-3/8" to 1-3/4"	1-3/8" to 1-3/4"	1-3/8" to 1-3/4"
Cross Bore	2-1/8"	2-1/8"	2-1/8"
Latch/Backset	2-3/8" to 2-3/4" adjustable	2-3/8" to 2-3/4" adjustable	2-3/8" to 2-3/4" adjustable
Latch Faceplate Size	1" x 2-1/4"	1" x 2-1/4"	1" x 2-1/4"
Latch Faceplate Options	Round corner, square corner, and drive-in (dual option standard)	Spring latch radius corner and circular drive-in faceplates	Round corner, square corner, and drive-in (dual option standard)
Strike	1-1/8" x 2-3/4" round corners, strike reinforce	1-5/8" x 2-1/4", radius corner, full lip latch strikes	1-1/8" x 2-3/4" round corners, strike reinforce
Keys	1 Key	1 Key	1 Key
Codes	2 pre-set unique 4-digit access codes, storage of up to 19 access codes	2 pre-set unique 4-digit access codes, storage of up to 19 access codes	2 pre-set unique 4-digit access codes, storage of up to 19 access codes
Operating Temperatures	Outside lock body (exterior mounted): -35°C to 66°C Inside lock body (interior mounted): -10°C to 50°C	Outside lock body (exterior mounted): -35°C to 66°C Inside lock body (interior mounted): -10°C to 50°C	Outside lock body (exterior mounted): -35°C to 66°C Inside lock body (interior mounted): -10°C to 50°C

PACKAGING & CARTON SPECS

	INDIVIDUAL CARTON				SHIPPER					
	CARTON WEIGHT	HEIGHT	WIDTH	DEPTH	QTY. SHIPPER	CARTON WEIGHT	CU. FT.	HEIGHT	WIDTH	DEPTH
Levers										
FE375	3.31	4.63 in.	9.25 in.	5.00 in.	6	20.80	0.83	9.75 in.	9.50 in.	15.50 in.
FE695	4.04	6.00 in.	6.50 in.	9.13 in.	6	27.00	1.44	9.75 in.	12.75 in.	20.00 in.
BE365	5.50	4.22 in.	6.77 in.	8.39 in.	6	33.00	1.00	9.30 in.	13.50 in.	14.10 in.
FE595	5.05	4.75 in.	8.00 in.	9.50 in.	6	30.30	1.50	10.60 in.	14.00 in.	17.00 in.
FE575	4.25	4.75 in.	8.00 in.	9.50 in.	6	25.50	1.50	10.60 in.	14.00 in.	17.00 in.
JFE105	6.50	6.48 in.	6.38 in.	6.81 in.	4	14.24		7.60 in.	13.78 in.	14.69 in.

For Vis Pack carton specs, see page 106.

Schlage Touch® Deadbolts



exterior



interior

BE375
Camelot
(CAM)



exterior

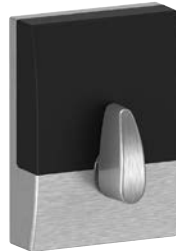

interior

BE375
Century
(CEN)

BE375 Series
Schlage Touch® Deadbolts

FINISHES

Function	Style/Design	Packaging	605	505	608	609	618	619	620	621	622	625	626	716
BE375	Camelot	Box	\$338	•	•	\$344	•	\$344	•	•	\$344	\$344	\$344	\$344
BE375	Century	Box/Vis	•	•	•	•	•	\$344	•	•	\$344	\$344	\$344	\$344

List Price Adders:

Visual Package Options (highlighted) - add \$7.00 to list price.

Triple Option Latch - add \$3.00 to list price.

Schlage Touch® Levers



exterior interior

FE695
Camelot x Accent
(CAM) (ACC)



exterior interior

FE695
Camelot x Flair
(CAM) (FLA)



exterior interior

FE695
Century x Broadway
(CEN) (BRW)



exterior interior

FE695
Century x Latitude
(CEN) (LAT)



exterior interior

FE695
Century x Merano
(CEN) (MER)

FE695 Series

Schlage Touch® Keyless Touchscreen Levers

FINISHES

Function	Style/Design	Packaging	605	505	608	609	618	619	620	621	622	625	626	716
(CAM) Camelot														
FE695	Accent	Box	\$365	•	•	\$370	•	\$370	•	•	\$370	\$370	\$370	\$370
FE695	Flair	Box	\$365	•	•	\$370	•	\$370	•	•	•	•	\$370	\$370
(CEN) Century														
FE695	Broadway	Box	•	•	•	•	•	\$370	•	•	\$370	\$370	\$370	\$370
FE695	Elan	Box	•	•	•	•	•	•	•	•	•	•	\$370	•
FE695	Latitude	Box/Vis	•	•	•	•	•	\$370	•	•	\$370	\$370	\$370	\$370
FE695	Merano	Box	•	•	•	•	•	\$370	•	•	\$370	\$370	\$370	\$370

List Price Adders:

Visual Package Options (highlighted) - add \$7.00 to list price.

Triple Option Latch - add \$3.00 to list price.

Keypad Deadbolts



exterior



interior

BE365
Camelot
(CAM)



exterior



interior

BE365
Plymouth
(PLY)

**BE Series
Keypad Deadbolts**

FINISHES

Function	Packaging	605	505	530	608	609	618	619	620	621	622	625	626	716
BE365 Camelot	Box/Vis	•	\$304	\$304	•	\$304	•	\$304	\$304	•	\$304	•	\$304	\$304
BE365 Plymouth	Box/Vis	•	\$304	•	•	\$304	•	\$304	\$304	•	\$304	•	\$304	\$304
BE365F20 Camelot	Box	•	\$323	•	•	\$323	•	\$323	\$323	•	\$323	•	\$323	\$323
BE365F20 Plymouth	Box	•	\$323	•	•	\$323	•	\$323	\$323	•	\$323	•	\$323	\$323
BE365F Camelot UL	Box	•	\$377	•	•	\$377	•	\$377	\$377	•	\$377	•	\$377	\$377
BE365F Plymouth UL	Box	•	\$377	•	•	\$377	•	\$377	\$377	•	\$377	•	\$377	\$377

List Price Adders:

Visual Package Options (highlighted) - add \$7.00 to list price.
Triple Option Latch - add \$3.00 to list price.

Note: BE365F20 is UL listed for 20 minute fire door, no hose (US Only). BE365F is UL listed for 3 hour fire door.

Keypad Entry with Flex-Lock



FE595 Series
Keypad Entry Lever or Knob with Flex-Lock

FINISHES

Function	Style/Design	Packaging	605	505	608	609	618	619	620	621	622	625	626	716
(CAM) Camelot														
FE595	Accent Lever	Box/Vis	•	\$330	•	\$330	•	\$330	\$330	•	\$330	•	\$330	\$330
FE595	Georgian Knob	Box	•	\$310	•	\$310	•	\$310	•	•	\$310	•	•	\$310
(PLY) Plymouth														
FE595	Accent Lever	Box	•	\$330	•	•	•	\$330	\$330	•	\$330	•	•	\$330
FE595	Elan Lever	Box	•	•	•	•	•	•	•	•	•	•	\$330	•
FE595	Flair Lever	Box/Vis	•	\$330	•	\$330	•	\$330	\$330	•	•	•	\$330	\$330
FE595	Jazz Lever	Box	•	•	•	•	•	•	•	•	•	•	\$330	•
FE595	Latitude Lever	Box/Vis	•	•	•	•	•	\$330	•	•	\$330	•	\$330	•
FE595	Merano Lever	Box	•	•	•	•	•	\$330	•	•	\$330	•	•	•
FE595	Plymouth Knob	Box	•	\$310	•	•	•	\$310	•	•	\$310	•	•	•
FE595CSV	Elan Lever*	Vis	•	•	•	•	•	•	•	•	•	•	\$345	\$345
FE595CSV	Orbit Knob	Vis	•	•	•	•	•	•	•	•	•	•	\$325	•

List Price Adders:

Visual Package Options (highlighted) - add \$7.00 to list price.

Triple Option Latch - add \$3.00 to list price.

* Contractor Series. Visual Package and Triple Option Latch only - add \$15.00 to list price.

Keypad Entry with Auto-Lock

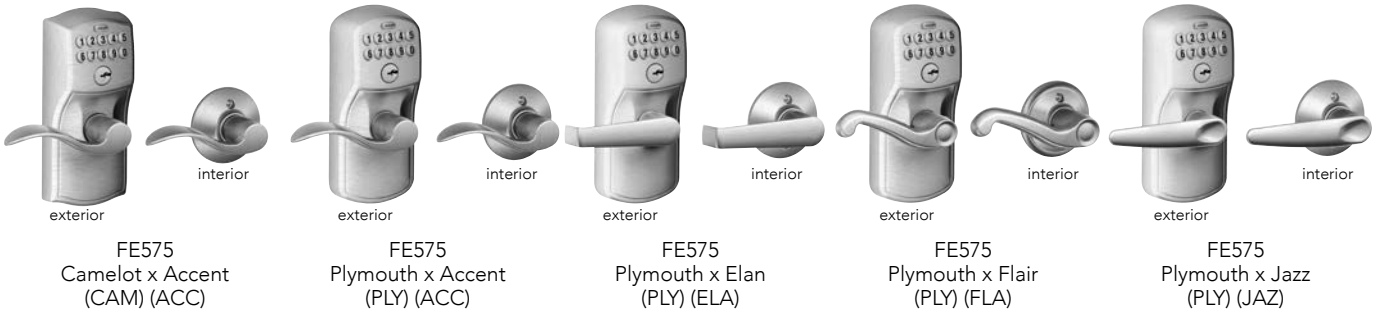

FE575 Series

Keypad Entry Lever or Knob with Auto-Lock

FINISHES

Function	Style/Design	Packaging	605	505	608	609	618	619	620	621	622	625	626	716
(CAM) Camelot														
FE575	Accent Lever	Box	•	\$317	•	\$317	•	\$317	\$317	•	•	•	\$317	\$317
(PLY) Plymouth														
FE575	Accent Lever	Box	•	•	•	•	•	\$317	\$317	•	•	•	•	\$317
FE575	Elan Lever	Box	•	•	•	•	•	•	•	•	•	•	\$317	•
FE575	Flair Lever	Box	•	\$317	•	\$317	•	\$317	\$317	•	•	•	\$317	\$317
FE575	Jazz Lever	Box	•	•	•	•	•	•	•	•	•	•	\$317	•
FE575	Plymouth Knob	Box	•	\$317	•	•	•	•	•	•	•	•	•	•

F Series 21
 F Series Decorative collection 28
 J Series 29

F Series Handlesets
AVAILABLE FUNCTIONS

F58 F59 F60 F62 F92 F94 F93 FE285

ANSI/BHMA A156.36 Commercial Grade 1
ANSI/BHMA A156.40 Residential Grade AAA
Entrance Handlesets

F58 – Handleset/Entrance Lock Exterior

- Outside grip and deadbolt trim of F60
- Pair with an F59 for a complete handleset

F59 – Handleset/Entrance Lock Interior

- Inside trim, deadbolt thumbturn, latches, strikes & screws for F60
- Pair with an F58 for a complete handleset

F60 – Single Cylinder Deadbolt/Entrance Lock

- Deadbolt thrown or retracted by key from outside or by inside thumbturn
- Latch retracted by thumbpiece from outside or by inside knob/lever

F62 – Double Cylinder Handleset/Entrance Lock*

- Deadbolt thrown or retracted by key from either side
- Latch retracted by thumbpiece from outside or by inside knob/lever

F92 – Inactive Handleset Exterior

- Outside inactive grip & dummy deadbolt
- Pair with an F94 for a complete inactive handleset

F94 – Inactive Handleset Interior

- Inside inactive knob/lever, blank deadbolt trim & screws
- Pair with an F92 for a complete inactive handleset

F93 – Inactive Handleset

- For use as door pull or as decorative trim on inactive leaf of pair of doors
- Fixed thumbpiece and inside knob/lever
- Decorative deadbolt with inside trim

FE285 - Lower Half - Front Entry Set

- Combine with Electronic Deadbolt for complete Front Entry Set
- Latch retracted by thumbpiece from outside or by inside knob/lever

*CAUTION: Double cylinder locks on residences and any door in any structure which is used for egress are a life safety hazard in times of emergency and their use is not recommended. Installation should be in accordance with existing codes only.

PRODUCT IDENTIFICATION

F	60	F	CEN	619	MER	CEN	RH	12-322	10-115	KD
Lock Series	Product	UL Fire Rated (G - Graphic Cover)	Style	Finish Code	Design	Decorative Trim	Hand	Latch	Strike	Keying

LATCHES & STRIKES

Latches

- 12-322** - Dual Option - Round Corner + Drive-in (16-080 + 12-321) **STANDARD**
- 12-326** - Triple Option - Round Corner + Square Corner + Drive-in (16-210 + 12-287)
- 12-353** - F60/62 UL Listed, 1" Square Corner
- 12-354** - F60/62 UL Listed, 1" Round Corner

Strikes

- 10-115** - Round Corner Full Lip Strike Set (10-027 + 10-116) **STANDARD**
- 10-269** - Round Corner Strike Set (10-026 + 10-027 + 10-116)
- 10-257** - Round Corner Full Lip (10-027 + 10-092)

STANDARD FEATURES / CONFIGURATIONS

F Series Entrance Handlesets¹	
Certification	ANSI/BHMA A156.36-2016 Commercial Grade 1 (F58, F59, F60, F62 only), Grade 2 (FE285) ANSI/BHMA A156.40-2015 Residential Grade AAA
Latch	1" x 2-1/4", 1/4" radius corner faceplate, 7/8" housing diameter, 1/2" throw spring latch
Deadbolt	1" x 2-1/4", 1/4" radius corner faceplate, 1" housing diameter, 1" throw, latchset number 12-321
Strike	Part 10-269, includes: 1-1/4" radius corner deadbolt strike (10-116), radius round corner full lip strike (10-027)
Reinforcement	Integrated strike and reinforcer with 3" screws
Backset	Universal backset latch and deadbolt, fits either 2-3/8" or 2-3/4" backsets
Cylinder	5-Pin, keyed 5-Pin, C keyway, keyed different (KD) Also available in Keyed Alike (KA), Residential Construction Key (RCK) ² , Residential Master Key (RMK) ² , and commercial Master Key (MK)
Door Range³	1-1/2" – 1-7/8"
Keys	Two 48-180 cut keys per lock, 5-pin, C section
Adjustable Throughbolt	Adjustable throughbolt can move up and down 1-1/2" to fit a variety of pre-existing holes

¹ Locks are furnished with standard features unless otherwise specified. To order locks with non-standard features, specify non-standard feature desired.
² See pricing for RCK and RMK in Hardware & Accessories section.
³ Thick door kit available for door thicknesses up to 2-1/4". See Parts sections for item number and pricing.

FINISH CODES & DESCRIPTIONS

505	605	608	609	618	619	620	621	622	625	626	716
Lifetime Bright Brass	Bright Brass (US3)	Satin Brass	Antique Brass (US5)	Polished Nickel	Satin Nickel (US15)	Antique Pewter (US15A)	Distressed Nickel	Matte Black (US19)	Bright Chrome (US26)	Satin Chrome (US26D)	Aged Bronze

Non-standard finishes are not available.
 Full-color swatch examples available on inside Handleset tab.

PACKAGING & CARTON SPECS

	INDIVIDUAL CARTON				SHIPPER						
	CARTON WEIGHT	HEIGHT	WIDTH	DEPTH	QTY. SHIPPER	CARTON WEIGHT	CU. FT.	HEIGHT	WIDTH	DEPTH	
Levers											
F58	4.30	3.90 in.	7.97 in.	16.25 in.	4.00	22.00	1.36	8.50 in.	16.00 in.	17.25 in.	
F59	1.75	3.62 in.	4.31 in.	8.06 in.	8.00	20.00	0.94	6.00 in.	15.00 in.	18.00 in.	
F60	6.16	3.90 in.	7.97 in.	16.25 in.	4.00	23.00	1.36	8.50 in.	16.00 in.	17.25 in.	
F62	6.36	3.90 in.	7.97 in.	16.25 in.	4.00	24.00	1.36	8.50 in.	16.00 in.	17.25 in.	
F92	4.30	3.90 in.	7.97 in.	16.25 in.	4.00	22.00	1.36	8.50 in.	16.00 in.	17.25 in.	
F94	1.75	3.62 in.	4.31 in.	8.06 in.	20.00	33.60	1.73	9.13 in.	18.12 in.	18.12 in.	
F93	5.75	3.90 in.	7.97 in.	16.25 in.	4.00	22.00	1.36	8.50 in.	16.00 in.	17.25 in.	
FE285	5.00	3.88 in.	8.00 in.	16.25 in.	4.00	21.00	0.02	8.50 in.	16.00 in.	17.25 in.	

For Retail Pack carton specs, see page 106.

AVAILABLE STYLES

**F58
Available
Exterior
Styles**

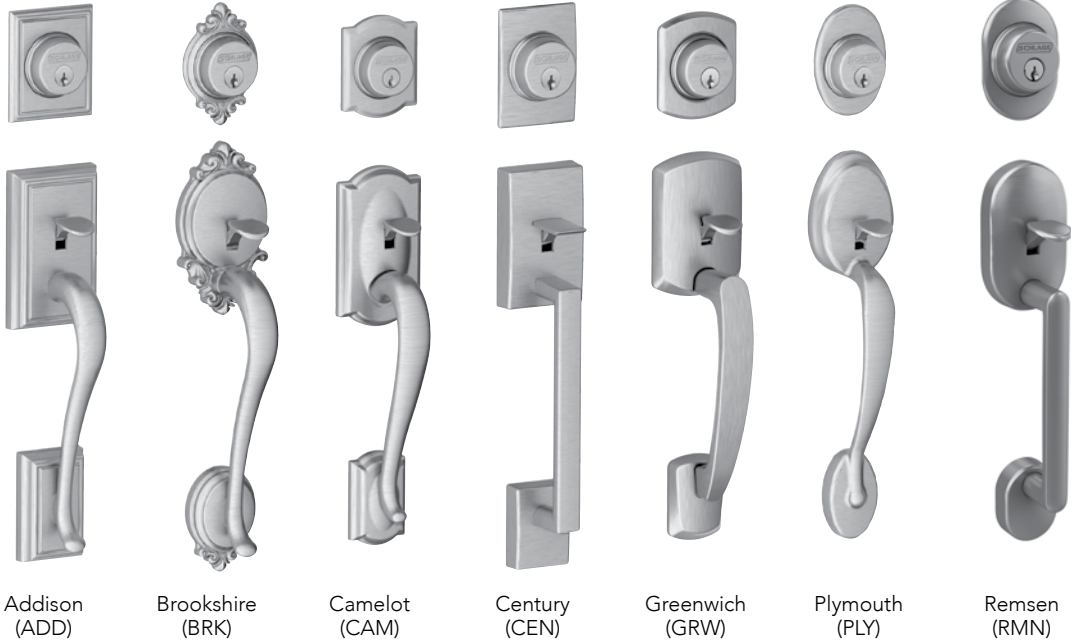

F59 Available Interior Styles

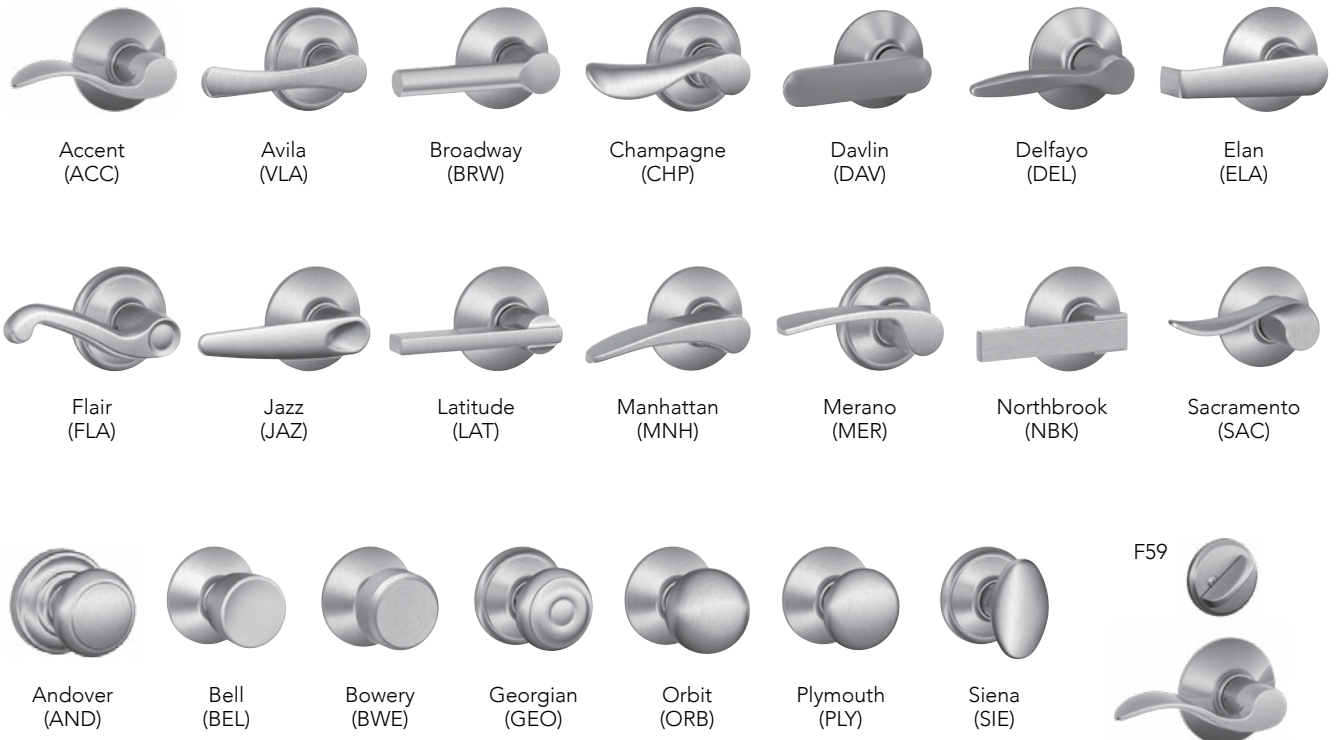

**F58 Series
Handleset Exterior**
FINISHES

Style/Design	Packaging	605	505	608	609	618	619	620	621	622	625	626	716
(ADD) Addison	Box	•	•	•	\$244	•	\$244	\$244	\$244	\$244	\$244	•	\$244
(BRK) Brookshire	Box	\$198	•	•	\$244	•	\$244	•	•	\$244	•	•	\$244
(CAM) Camelot	Box	\$192	\$237	\$237	\$237	•	\$237	\$237	•	\$237	\$237	•	\$237
(CEN) Century	Box	•	•	\$237	•	\$237	\$237	•	•	\$237	\$237	\$237	\$237
(GRW) Greenwich	Box	•	•	•	•	\$244	\$244	•	•	\$244	\$244	\$244	\$244
(PLY) Plymouth	Box	\$180	\$226	•	\$226	•	\$226	\$226	•	\$226	\$226	\$226	\$226
(RMN) Remsen	Box	•	•	\$244	•	•	\$244	•	•	\$244	\$244	•	\$244

**F59 Series
Handleset/Entrance Lock Interior**
FINISHES

Style/Design	Packaging	605	505	608	609	618	619	620	621	622	625	626	716
Interior Thumbturn & Interior Lever													
(ACC) Accent Lever*	Box	\$134	•	\$141	\$141	\$141	\$141	\$141	\$141	\$141	\$141	\$141	\$141
(VLA) Avila Lever	Box	\$130	•	•	\$136	•	\$136	•	•	•	\$136	\$136	\$136
(BRW) Broadway Lever	Box	•	•	•	•	•	\$141	•	•	\$141	\$141	\$141	\$141
(CHP) Champagne Lever*	Box	•	•	•	•	•	\$153	•	•	•	•	•	\$153
(DAV) Davlin Lever	Box	•	•	\$141	•	•	\$141	•	•	\$141	\$141	•	\$141
(DEL) Delfayo Lever*	Box	•	•	\$141	•	•	\$141	•	•	\$141	\$141	•	\$141
(ELA) Elan Lever	Box	\$134	•	•	\$141	•	\$141	•	•	\$141	\$141	\$141	\$141
(FLA) Flair Lever*	Box	\$134	•	\$141	\$141	•	\$141	\$141	•	\$141	\$141	\$141	\$141
(JAZ) Jazz Lever	Box	•	•	•	•	•	\$141	•	•	\$141	\$141	\$141	\$141
(LAT) Latitude Lever	Box	•	•	\$141	•	\$141	\$141	•	•	\$141	\$141	\$141	\$141
(MER) Merano Lever*	Box	•	•	•	•	•	\$141	•	•	\$141	\$141	\$141	\$141
(MNH) Manhattan Lever*	Box	•	•	•	•	•	\$141	•	•	•	\$141	\$141	•
(NBK) Northbrook Lever	Box	•	•	•	•	•	\$141	•	•	•	•	•	•
(SAC) Sacramento Lever*	Box	•	•	•	•	\$136	\$136	•	•	•	\$136	\$136	\$136
Interior Thumbturn & Interior Knob													
(AND) Andover Knob	Box	\$116	•	•	\$120	•	\$120	\$120	•	•	\$120	\$120	\$120
(BEL) Bell Knob	Box	\$107	•	•	\$112	•	•	•	•	•	•	\$122	•
(BWE) Bowery Knob	Box	•	•	\$120	•	\$120	\$120	•	•	\$120	\$120	\$120	\$120
(GEO) Georgian Knob	Box	\$107	•	\$112	\$112	•	\$112	\$112	\$112	\$112	\$112	•	\$112
(ORB) Orbit Knob	Box	\$116	•	•	•	•	\$120	•	•	•	\$120	\$120	•
(PLY) Plymouth Knob	Box	\$107	•	•	\$112	•	\$112	\$112	•	\$112	\$112	\$112	\$112
(SIE) Siena Knob	Box	\$125	•	•	\$130	•	\$130	\$130	•	\$130	\$130	\$130	\$130

* Specify handing.

Note: For F60 Pricing, combine pricing from F58 Series and F59 Series above.

List Price Adders:

Retail Package Options - add \$23.00 to list price (F60 and F62 Only).

Decorative Trim Option - See chart on page 28.

Triple Option Latch - add \$3.00 to list price; Box Pack Only.

**F92 Series
Inactive Handleset Exterior**

Style/Design	Packaging	FINISHES											
		605	505	608	609	618	619	620	621	622	625	626	716
(ADD) Addison	Box	•	•	•	\$232	•	\$232	\$232	\$232	\$232	\$232	•	\$232
(BRK) Brookshire	Box	\$186	•	•	\$232	•	\$232	•	•	\$232	•	•	\$232
(CAM) Camelot	Box	\$177	\$222	•	\$222	•	\$222	\$222	•	\$222	\$222	•	\$222
(CEN) Century	Box	•	•	•	•	\$222	\$222	•	•	\$222	\$222	\$222	\$222
(GRW) Greenwich	Box	•	•	•	•	•	\$232	•	•	\$232	\$232	\$232	\$232
(PLY) Plymouth	Box	\$169	\$214	•	\$214	•	\$214	\$214	•	\$214	\$214	\$214	\$214
(RMN) Remsen	Box	•	•	\$232	•	•	\$232	•	•	\$232	\$232	•	\$232

**F94 Series
Inactive Handleset Interior**

Style/Design	Packaging	FINISHES												
		605	505	608	609	618	619	620	621	622	625	626	716	
Interior Lever														
(ACC) Accent Lever*	Box	\$82	•	•	\$88	\$88	\$88	\$88	\$88	\$88	\$88	\$88	\$88	\$88
(VLA) Avila Lever	Box	\$78	•	•	\$84	•	\$84	•	•	•	\$84	\$84	\$84	
(BRW) Broadway Lever	Box	•	•	•	•	•	\$88	•	•	\$88	\$88	\$88	\$88	
(CHP) Champagne Lever*	Box	•	•	•	•	•	\$101	•	•	•	•	•	\$101	
(DAV) Davlin Lever	Box	•	•	\$88	•	•	\$88	•	•	\$88	\$88	•	\$88	
(DEL) Delfayo Lever*	Box	•	•	\$88	•	•	\$88	•	•	\$88	\$88	•	\$88	
(ELA) Elan Lever	Box	\$82	•	•	\$88	•	\$88	•	•	\$88	\$88	\$88	\$88	
(FLA) Flair Lever*	Box	\$82	•	•	\$88	•	\$88	\$88	•	\$88	\$88	\$88	\$88	
(JAZ) Jazz Lever	Box	•	•	•	•	•	\$88	•	•	•	•	\$88	•	
(LAT) Latitude Lever	Box	•	•	•	•	\$88	\$88	•	•	\$88	\$88	\$88	\$88	
(MER) Merano Lever*	Box	•	•	•	•	•	\$88	•	•	\$88	\$88	\$88	\$88	
(MNH) Manhattan Lever*	Box	•	•	•	•	•	\$88	•	•	•	\$88	\$88	•	
(NBK) Northbrook Lever	Box	•	•	•	•	•	\$88	•	•	•	•	•	•	
(SAC) Sacramento Lever*	Box	•	•	•	•	\$84	\$84	•	•	•	\$84	\$84	\$84	
Interior Knob														
(AND) Andover Knob	Box	\$66	•	•	\$69	•	\$69	\$69	•	•	\$69	\$69	\$69	
(BEL) Bell Knob	Box	\$56	•	•	\$59	•	•	•	•	•	•	\$59	•	
(BWE) Bowery Knob	Box	•	•	•	•	\$69	\$69	•	•	\$69	\$69	\$69	\$69	
(GEO) Georgian Knob	Box	\$56	•	•	\$59	•	\$59	\$59	\$59	\$59	\$59	•	\$59	
(ORB) Orbit Knob	Box	\$66	•	•	•	•	\$69	•	•	•	\$69	\$69	•	
(PLY) Plymouth Knob	Box	\$56	•	•	\$59	•	\$59	\$59	•	\$59	\$59	\$59	\$59	
(SIE) Siena Knob	Box	\$73	•	•	\$78	•	\$78	\$78	•	\$78	\$78	\$78	\$78	

* Specify handing.

Note: For F93 Pricing, combine pricing from F92 Series and F94 Series above.

List Price Adders:

Decorative Trim Option - See chart on page 28.

F62 Series
Handleset/Entrance Lock Interior & Exterior

Note: For F62 Pricing, combine pricing from F58 Series and F59 Series plus \$30.00 for the double cylinder.

FE285 Series
Handleset Exterior Options

Style/Design	Packaging	FINISHES											
		605	505	608	609	618	619	620	621	622	625	626	716
(ADD) Addison	Box	•	•	•	\$205	•	\$205	\$205	\$205	\$205	\$205	•	\$205
(BRK) Brookshire	Box	\$159	\$205	•	\$205	•	\$205	•	•	\$205	•	•	\$205
(CAM) Camelot	Box	\$153	\$198	\$198	\$198	•	\$198	\$198	•	\$198	\$198	•	\$198
(CEN) Century	Box	•	•	\$198	•	•	\$198	•	•	\$198	\$198	\$198	\$198
(GRW) Greenwich	Box	•	•	•	•	•	\$205	•	•	\$205	\$205	\$205	\$205
(PLY) Plymouth	Box	\$143	\$189	•	\$189	•	\$189	\$189	•	\$189	\$189	\$189	\$189
(RMN) Remsen	Box	•	•	\$205	•	•	\$205	•	•	\$205	\$205	•	\$205

**FE285 Series
Handleset Interior Options**
FINISHES

Style/Design	Packaging	605	505	608	609	618	619	620	621	622	625	626	716
Interior Thumbturn & Interior Lever													
(ACC) Accent Lever*	Box	\$95	•	\$101	\$101	\$101	\$101	\$101	\$101	\$101	\$101	\$101	\$101
(VLA) Avila Lever	Box	\$90	•	•	\$98	•	\$98	•	•	•	\$98	\$98	\$98
(BRW) Broadway Lever	Box	•	•	•	•	•	\$101	•	•	\$101	\$101	\$101	\$101
(CHP) Champagne Lever*	Box	•	•	•	•	•	\$114	•	•	•	•	•	\$114
(DAV) Davlin Lever	Box	•	•	\$101	•	•	\$101	•	•	\$101	\$101	•	\$101
(DEL) Delfayo Lever*	Box	•	•	\$101	•	•	\$101	•	•	\$101	\$101	•	\$101
(ELA) Elan Lever	Box	\$95	•	•	\$101	•	\$101	•	•	\$101	\$101	\$101	\$101
(FLA) Flair Lever*	Box	\$95	•	\$101	\$101	•	\$101	\$101	•	\$101	\$101	\$101	\$101
(JAZ) Jazz Lever	Box	•	•	•	•	•	\$101	•	•	•	•	\$101	•
(LAT) Latitude Lever	Box	•	•	\$101	•	\$101	\$101	•	•	\$101	\$101	\$101	\$101
(MER) Merano Lever*	Box	•	•	•	•	•	\$101	•	•	\$101	\$101	\$101	\$101
(MNH) Manhattan Lever*	Box	•	•	•	•	•	\$101	•	•	•	\$101	\$101	•
(NBK) Northbrook Lever	Box	•	•	•	•	•	\$101	•	•	•	•	•	•
(SAC) Sacramento Lever*	Box	•	•	•	•	\$98	\$98	•	•	•	\$98	\$98	\$98
Interior Thumbturn & Interior Knob													
(AND) Andover Knob	Box	\$78	•	•	\$82	•	\$82	\$82	•	•	\$82	\$82	\$82
(BEL) Bell Knob	Box	\$69	•	•	\$72	•	•	•	•	•	•	\$72	•
(BWE) Bowery Knob	Box	•	•	\$82	•	\$82	\$82	•	•	\$82	\$82	\$82	\$82
(GEO) Georgian Knob	Box	\$69	•	\$72	\$72	•	\$72	\$72	\$72	\$72	\$72	•	\$72
(ORB) Orbit Knob	Box	\$78	•	•	•	•	\$82	•	•	•	\$82	\$82	•
(PLY) Plymouth Knob	Box	\$69	•	•	\$72	•	\$72	\$72	•	\$72	\$72	\$72	\$72
(SIE) Siena Knob	Box	\$87	•	•	\$90	•	\$90	\$90	•	\$90	\$90	\$90	\$90

* Specify handing.

Note: For FE285 Pricing, combine pricing from Exterior Options and Interior Options above.

List Price Adders:

Decorative Trim Option - See chart on page 28.

Triple Option Latch - add \$3.00 to list price; Box Pack Only.

SCHLAGE'S HANDLESET DECORATIVE COLLECTIONS

Stand out *effortlessly*.

Schlage's Decorative Collections make it easy to match our strength to your style. With more than 1,000 customized design and finish options in all, your decor will be limited by only your imagination.



Pair a knob or lever with our inspired decorative trim options to bring your vision to life.*

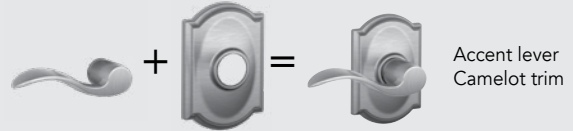

* Locks ship complete with trim attached

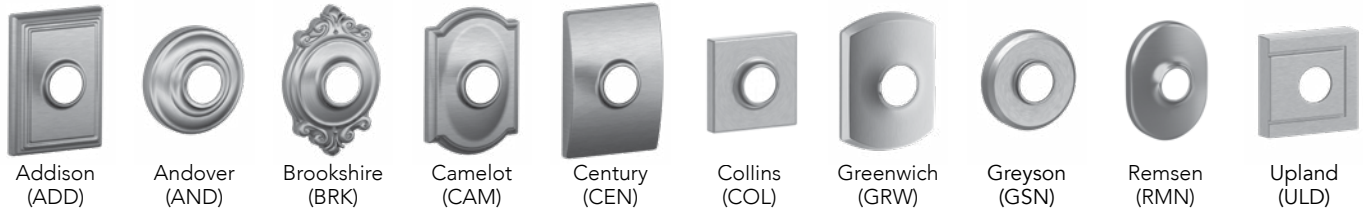

Follow these steps for pricing decorative combinations:

1. Locate the list price of the handleset in the Handlesets section.
2. Use the chart below to find the list price adder for the matching Decorative Collection upgrade.
3. Add the list prices together for the total list price of the new combination.

FOR F60 / F59 / F93 / F94 / FE285 / FE489 / FBE489

FINISHES AVAILABLE

Decorative trim finish	605	505	608	609	618	619	620	621	622	625	626	716
Addison (ADD) ¹	•	•	•	\$19	•	\$19	•	\$19	\$19	\$19	\$19	\$19
Andover (AND)	\$19	\$19	•	\$19	•	\$19	\$19	•	\$19	\$19	\$19	\$19
Brookshire (BRK)	•	•	•	\$19	•	\$19	•	•	•	•	•	\$19
Camelot (CAM)	\$19	\$19	\$19	\$19	•	\$19	\$19	•	\$19	\$19	•	\$19
Century (CEN)	•	•	\$19	•	\$19 ³	\$19	•	•	\$19	\$19	\$19	\$19
Collins (COL)	•	•	\$19	•	•	\$19	•	•	\$19	\$19	•	\$19
Greenwich (GRW)	•	•	•	•	\$19 ³	\$19	•	•	\$19	\$19	\$19	\$19
Greyson (GSN) ¹	•	•	•	•	\$19	\$19	•	•	\$19	\$19	•	\$19
Remsen (RMN)	•	•	\$19	•	•	\$19	•	•	\$19	\$19	•	\$19
Upland (ULD) ²	•	•	•	•	•	\$19	•	•	•	•	•	•



EXAMPLE 1: To Price a F59 ACC 619 CAM, take the list price of a F59 ACC 619 12-321 10-116 at \$141.00 and add the Camelot Decorative Trim Adder of \$19.00 for a total list price of \$160.00

\$141.00	(F59 ACC 619)
+ \$19.00	(Camelot Decorative Trim 619)
\$160.00	Total cost
	(F59 ACC 619 CAM)

When ordering a Handleset decorative collection product, specify the trim after the finish code. Example: F59 ACC 619 **CAM** or F59 ACC 619 **ADD**

¹ Andover, Greyson & Wakefield trim available on interior knob or lever and not on deadbolt.

² ULD trim available on interior knob or lever with COL trim on deadbolt.

³ Trim and finish combination not available for F92, F93, and F94 products.

To order
latches and strikes
see page 96-97

J Series Handlesets
AVAILABLE FUNCTIONS



JH58



JH59

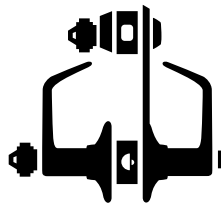

JI58/59



JI18/19

**ANSI/BHMA A156.36-2010 Commercial Grade 3
J Series Entrance Handlesets**

JH58 - Outside Handleset

- Outside grip and deadbolt trim

JH59 - Inside Handleset

- Inside trim, deadbolt thumbturn, latches, strikes & screws
- Available option for UL Listed for 3 hour fire door

JI58/59 - Keyed Entrance Lock (Interconnect)

- Deadbolt operated by key from outside or by turn unit from inside. Bolt automatically deadlocks when fully thrown
- Outside lever unlocked by key from outside when locked by turn-button in inside lever
- Turning inside lever retracts deadbolt and latch simultaneously for immediate exit
- Latch automatically deadlocks when door is closed
- Available option for UL Listed for 3 hour fire door

JI18/19 - Passage Lock with Keyed Deadbolt (Interconnect)

- Deadbolt operated by key from outside or by turn unit from inside
- Bolt automatically deadlocks when fully thrown
- Latch retracted by lever from either side
- Turning inside lever retracts deadbolt and latch simultaneously for immediate exit
- Available option for UL Listed for 3 hour fire door

PRODUCT IDENTIFICATION

JH	59		SEV	619	RH	16-068	10-103
Lock Series	Product	Suffix/Package	Style	Finish Code	Hand	Latch	Strike

LATCHES & STRIKES

Latches

16-258* - JH59/JH60 Triple Option Spring Latch - Round Corner + Square Corner + Drive-in + Triple Option Deadbolt Latch - Round Corner + Square Corner + Drive-in (16-070 + 16-068) - **STANDARD**

16-057** - JI19/JH59 UL Listed (16-059 + 16-063)

16-065*** - JI59 UL Listed (16-061 + 16-063)

* Sold separately as 16-068 and 16-070

** Sold separately as 16-059 and 16-063

*** Sold separately as 16-061 and 16-063

Strikes

10-268* - Radius Full Lip + Radius Deadbolt (10-101 + 10-102 + 10-103) - **STANDARD**

10-105 ** - Radius Full Lip + Square Corner Reinforced Deadbolt (10-101 + 10-099)

10-106 *** - JI19/JI59 Radius Full Lip + Radius Full Lip Dead bolt (10-101 + 10-102)

* Sold separately as 10-101 and 10-102 and 10-103

** Sold separately as 10-101 and 10-099

*** Sold separately as 10-101 and 10-102

NOTE:

1) Standard spring latch is Triple Option.

2) Standard deadbolt latch is Dual Option 1/4" round faceplate and drive-in latch.

STANDARD FEATURES / CONFIGURATIONS

J Series Entrance Handlesets	
Certification:	ANSI/BHMA A156.36-2010 Commercial Grade 3 Available option for UL Listed for 3 hour fire door (JH59, JI59, JI19 only)
Deadbolt	Dual Option: 1" x 2-1/4", 1/4" round corner and drive-in
Latch:	Round faceplates, drive-in latch, 1" housing diameter, 1" throw
Spring Latch:	Triple Option: 1" x 2-1/4", 1/4" round faceplate, drive-in latch
Deadbolt Strike:	1" x 2-1/4", round corner and radius corner, full lip
Latch Strike:	1-5/8" x 2-1/4", radius corner, full lip
Backset:	Adjustable for 2-3/8" or 2-3/4"
Cylinder:	5-pin, C keyway, keyed different (KD) Also available in Keyed Alike (KA), Residential Construction Key (RCK) ¹ , Residential Master Key (RMK) ¹ , and commercial Master Key (MK)
Door Range:	1-3/8" – 1-3/4"
Keys:	Two 48-155 brass cut keys per lock, 5-pin, C section

¹ See pricing for RCK and RMK in Hardware & Accessories section.

FINISH CODES & DESCRIPTIONS

605	609	619	620	622	625	626	630	716
Bright Brass (US3)	Antique Brass (US5)	Satin Nickel (US15)	Antique Pewter (US15A)	Matte Black (US19)	Bright Chrome (US26)	Satin Chrome (US26D)	Satin Stainless Steel (US32D)	Aged Bronze

Non-standard finishes are not available.

PACKAGING & CARTON SPECS

	INDIVIDUAL CARTON				SHIPPER						
	CARTON WEIGHT	HEIGHT	WIDTH	DEPTH	QTY. SHIPPER	CARTON WEIGHT	CU. FT.	HEIGHT	WIDTH	DEPTH	
Knobs											
JH58	3.47	3.46 in.	5.51 in.	12.20 in.	4	13.86	0.754	13.6 in.	8.0 in.	12.0 in.	
JH59	1.19	3.11 in.	2.56 in.	7.48 in.	24	28.62	1.142	8.7 in.	13.6 in.	16.8 in.	
JI58	0.64	2.76 in.	3.15 in.	13.39 in.	20	12.8	1.64	14.17 in.	13.39 in.	14.96 in.	
JI59	2.83	3.15 in.	3.94 in.	9.05 in.	12	33.96	1.1	10.35 in.	13.19 in.	13.89 in.	
JI18	1.19	2.79 in.	5.04 in.	6.22 in.	24	28.62	1.8	7.8 in.	18.31 in.	21.77 in.	
JI19	2.83	3.15 in.	3.94 in.	9.05 in.	12	33.96	1.1	10.35 in.	13.19 in.	13.89 in.	

For Vis Pack carton specs, see page 106.

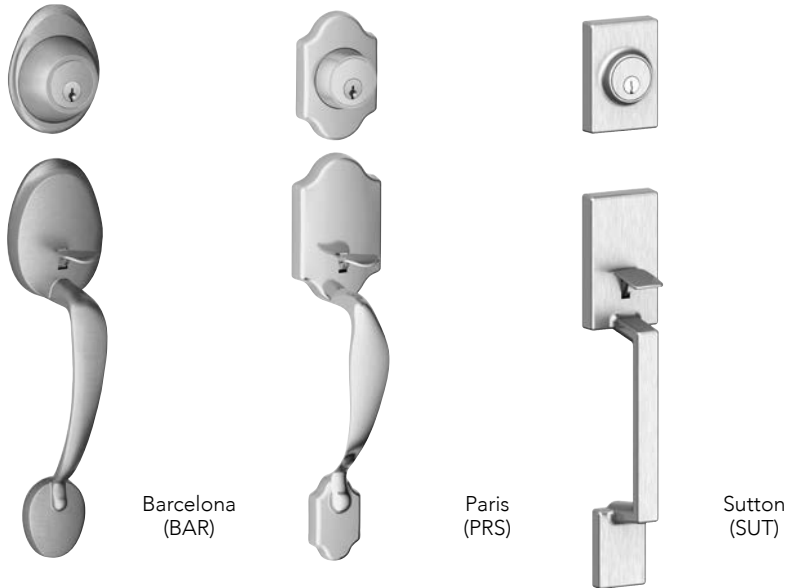
**JH58 Series
Handleset Exteriors**
FINISHES

Style/Design	Packaging	605	609	619	620	622	625	626	630	716
Handlesets Outside Trim, JH58 (JH58 + JH59 = complete handleset)										
JH58 (BAR) Barcelona	Box	\$128	\$128	\$128	\$128	\$128	\$128	•	\$128	\$128
JH58 (PRS) Paris	Box	\$128	\$128	\$128	•	•	\$128	•	\$128	\$128
JH58 (SUT) Sutton	Box	•	•	\$159	•	\$159	\$159	•	•	\$159
Handlesets Inside Trim, JH59 (JH58 + JH59 = complete handleset)										
JH59 (BYR) Byron Knob	Box	\$90	•	•	•	•	•	•	\$90	•
JH59 (CNA) Corona Knob	Box	\$90	\$90	\$90	\$90	•	\$90	•	\$90	\$90
JH59 (DUB) Dublin Knob	Box	•	•	\$90	•	•	•	•	•	\$90
JH59 (STR) Stratus Knob	Box	\$90	•	\$90	•	\$90	\$90	•	\$90	\$90
JH59 (DOV) Dover Lever	Box	•	•	\$104	•	•	•	•	\$104	\$104
JH5 (LAS) LaSalle Lever*	Box	\$104	\$104	\$104	•	•	•	•	•	\$104
JH59 (MAR) Marin Lever	Box	•	•	\$104	•	•	•	•	\$104	•
JH59 (SEV) Seville Lever*	Box	•	•	\$104	•	\$104	\$104	•	•	\$104
JH59 (TOR) Torino Lever	Box	•	•	\$104	\$104	•	\$104	•	\$104	\$104
JH59 (SOL) Solstice Lever	Box	•	•	\$109	•	\$109	\$109	\$109	•	\$109
JH59 (SOL) Solstice/COL Lever	Box	•	•	\$118	•	\$118	\$118	•	•	\$118
JH59 (BRW) Broadway/COL Lever	Box	•	•	\$118	•	\$118	\$118	•	•	\$118

* Specify handing.

Note: For JH60 Pricing, combine pricing from JH58 Series and JH59 Series above.

List Price Adders: UL Latch - add \$7.00 to list price (JH59 Box Pack Only).



J118
Marin (MAR)



J119
Marin (MAR)



J158
Torino (TOR)



J159
Torino (TOR)

**J1 Series
Interconnect Locksets-UL**

Style/Design	Packaging	FINISHES									
		605	609	619	620	622	625	626	630	716	
J158 Interconnect, Exterior Torino (TOR)	Box	•	•	•	•	•	•	•	\$101	•	
J159 Interconnect, Interior Torino (TOR)	Box	•	•	•	•	•	•	•	\$128	•	
J118 Interconnect, Exterior Marin (MAR)	Box	•	•	•	•	•	•	•	\$90	•	
J119 Interconnect, Interior Marin (MAR)	Box	•	•	•	•	•	•	•	\$115	•	

Note:
UL Latch add \$6.00 to list price (J159 and J119 functions only).
J118/19 and J158/59 can only be ordered individually.

**JE285 Series
Lower Half Front Entry Set Exterior & Interior**







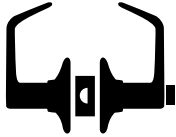

Style/Design	Packaging	FINISHES									
		605	609	619	620	622	625	626	630	716	
Barcelona Handleset											
(STR) Stratus Knob	Box	•	•	\$173	•	\$173	\$173	•	•	\$173	
(SEV) Seville Lever*	Box	•	•	\$189	•	\$189	\$189	•	•	\$189	
Paris Handleset											
(CNA) Corona Knob	Box	•	•	\$173	•	•	\$173	•	•	\$173	
(STR) Stratus Knob	Box	•	•	\$173	•	•	•	•	•	\$173	
(TOR) Torino Lever	Box	•	•	\$189	•	•	•	•	•	\$189	
(SOL) Solstice Lever	Box	•	•	\$193	•	•	•	•	•	•	
(BRW) Broadway/COL Lever	Box	•	•	\$200	•	•	•	•	•	•	
(SOL) Solstice/COL Lever	Box	•	•	\$200	•	•	•	•	•	•	
Sutton Handleset											
(STR) Stratus Knob	Box	•	•	\$200	•	\$200	\$200	•	•	\$200	
(SOL) Solstice Lever	Box	•	•	\$220	•	\$220	\$220	•	•	\$220	
(SOL) Solstice/COL Lever	Box	•	•	\$227	•	\$227	\$227	•	•	\$227	

* Specify handing.

Note: JE285 Pricing listed above combines Exterior Option and Interior Option.

F Series 33
 F Series Decorative collection 43
 J Series 44

F Series Levers AVAILABLE FUNCTIONS

Non-keyed Locks			Keyed Locks	
				
Schlage ANSI	F10 F75	F40 F76	F51A F81	F80 F86
ANSI/BHMA A156.2-2017 Commercial Grade 2 ANSI/BHMA A156.39-2015 Residential Grade AAA				
Non-keyed Locks			Keyed Locks	
	F10 (ANSI F75) – Hall & Closet			F51A (ANSI F81) – Keyed Entry
	<ul style="list-style-type: none"> • Both knobs/levers always unlocked 			<ul style="list-style-type: none"> • Keyed entry function unlocks when door is opened from the inside, allowing you to leave quickly, conveniently and re-enter easily • Locked by inserting key and rotating cylinder from outside, or manually rotating interior turn-button after exit
	F40 (ANSI F76) – Bed & Bath			F80 (ANSI F86) – Storeroom Lock
	<ul style="list-style-type: none"> • Push-button locking • Can be opened from outside with small circular tool • Turning inside knob/lever releases button 			<ul style="list-style-type: none"> • Outside knob/lever fixed. Entrance by key only. • Inside knob/lever always unlocked
	F170 – Non-turning			
	<ul style="list-style-type: none"> • Non-turning trim for one side of door • Used for door pull or as matching inactive trim 			

PRODUCT IDENTIFICATION

F	51A	F	ACC	619	CAM	RH	16-086	10-027	KA4
Lock Series	Product	UL Fire Rated (V - VisPack) (G - Graphic Cover)	Style	Finish Code	Decorative Trim	Hand	Latch	Strike	Keying

LATCHES & STRIKES

Keyed Latches - Dead Latches

- 16-086** - Dual Option (Round, Drive-in) **STANDARD**
- 16-207** - Square Corner
- 16-211** - Triple Option (Round, Square, Drive-in)
- 16-203** - UL Listed Square Corner with Firecup
- 16-204** - UL Listed Round Corner with Firecup
- 16-126** - 5" Backset, Square Corner

Non Keyed - Spring Latches

- 16-080** - Dual Option (Round, Drive-in) **STANDARD**
- 16-200** - Square Corner
- 16-210** - Triple Option (Round, Square, Drive-in)
- 16-203** - UL Listed Square Corner with Firecup
- 16-204** - UL Listed Round Corner with Firecup

Strikes

- 10-027** - Round Corner Full Lip **STANDARD**
- 10-001** - Square Corner T Strike
- 10-026** - Square Corner Full Lip
- 10-058** - Circular - Adjustable
- 10-063** - Dual Strikes (Round & Square Full Lip)
- 10-025** - ANSI Square Corner

STANDARD FEATURES / CONFIGURATIONS

F Series Levers/Decorative Trim¹	
	Description
Certification:	ANSI/BHMA A156.2-2017 Commercial Grade 2 ANSI/BHMA A156.39-2015 Residential Grade AAA Available UL Listed for 3-hour fire door (F10, F40 (CSV Only), F51A, F80 functions)
Latch:	1" x 2-1/4", 1/4" radius corner faceplate, 7/8" housing diameter, 1/2" throw, circular drive-in included, universal latch
Strike:	1-5/8" x 2-1/4" radius corner, full lip, no box
Backset:	Dual backset latches, fits either 2-3/8" or 2-3/4" backsets
Cylinder:	5-Pin, C keyway, Keyed Alike (KA4) Also available in Keyed Different (KD), Residential Construction Key (RCK) ² , Residential Master Key (RMK) ² , and commercial Master Key (MK)
Door Range:	1-3/8" – 1-3/4"
Keys:	Two 48-180 keys per lock, 5-pin, C section

¹ Locks are furnished with standard features unless otherwise specified. To order locks with non-standard features, specify non-standard feature desired.
² See pricing for RCK and RMK in Hardware & Accessories section.

FINISH CODES & DESCRIPTIONS

505	605	608	609	618	619	620	621	622	625	626	716
Lifetime Bright Brass	Bright Brass (US3)	Satin Brass	Antique Brass (US5)	Polished Nickel	Satin Nickel (US15)	Antique Pewter (US15A)	Distressed Nickel	Matte Black (US19)	Bright Chrome (US26)	Satin Chrome (US26D)	Aged Bronze

Non-standard finishes are not available.
Full-color swatch examples available on inside Levers tab.

PACKAGING & CARTON SPECS

	INDIVIDUAL CARTON				SHIPPER						
	CARTON WEIGHT	HEIGHT	WIDTH	DEPTH	QTY. SHIPPER	CARTON WEIGHT	CU. FT.	HEIGHT	WIDTH	DEPTH	
Levers											
F10	1.55	3.25 in.	6.00 in.	7.00 in.	8	12.50	0.760	7.8 in.	12.6 in.	13.5 in.	
F40	1.55	3.25 in.	6.00 in.	7.00 in.	8	12.50	0.760	7.8 in.	12.6 in.	13.5 in.	
F51A	1.55	3.25 in.	6.00 in.	7.00 in.	8	12.50	0.760	7.8 in.	12.6 in.	13.5 in.	
F80	1.55	3.25 in.	6.00 in.	7.00 in.	8	12.50	0.760	7.8 in.	12.6 in.	13.5 in.	
F170	0.80	2.86 in.	4.38 in.	5.66 in.	20	16.00	1.000	6.5 in.	15.3 in.	18.3 in.	
Decorative Collections Levers											
All Levers	1.55	3.25 in.	6.00 in.	7.00 in.	8	19.00	1.090	8.13 in.	12.63 in.	18.4 in.	
F170	1.20	2.86 in.	4.38 in.	5.66 in.	20	25.00	1.000	6.5 in.	15.3 in.	18.3 in.	

For Retail Pack carton specs, see page 106.

AVAILABLE STYLES



Accent
(ACC)



Avila
(VLA)



Broadway
(BRW)



Champagne
(CHP)



Davlin
(DAV)



Delfayo
(DEL)



Elan
(ELA)



Flair
(FLA)

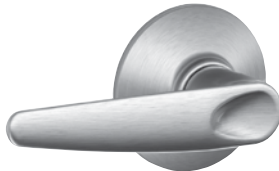

Jazz
(JAZ)



Latitude
(LAT)



Manhattan
(MNH)



Merano
(MER)

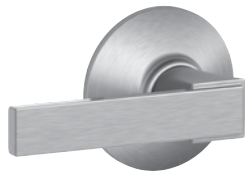

Northbrook
(NBK)



Sacramento
(SAC)



Accent
(ACC)

RECOMMENDED DECORATIVE TRIM

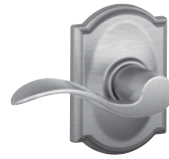

Accent lever
with Camelot trim



Accent Lever
with Addison Trim



Accent Lever
with Collins Trim

(ACC) Accent

FINISHES

Function	Packaging	605	505	608	609	618	619	620	621	622	625	626	716
F10 Hall & Closet	Box/Vis	\$64	\$71	\$71	\$71	\$71	\$71	\$71	\$71	\$71	\$71	\$71	\$71
F40 Bed & Bath	Box/Vis	\$67	•	\$74	\$74	\$74	\$74	\$74	\$74	\$74	\$74	\$74	\$74
F51A Keyed Entry	Box/Vis	\$123	\$133	\$133	\$133	\$133	\$133	\$133	\$133	\$133	\$133	\$133	\$133
F80* Storeroom	Box	\$136	\$144	\$144	\$144	\$144	\$144	\$144	\$144	\$144	\$144	\$144	\$144
F170* Non-turning	Box/Vis	\$31	•	\$37	\$37	\$37	\$37	\$37	\$37	\$37	\$37	\$37	\$37

* Specify handing.



Avila
(VLA)

RECOMMENDED DECORATIVE TRIM



Avila lever
with Addison trim

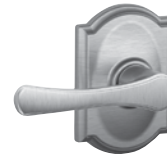

Avila lever
with Camelot trim

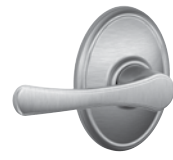

Avila lever
with Wakefield trim

(VLA) Avila

FINISHES

Function	Packaging	605	505	608	609	618	619	620	621	622	625	626	716
F10 Hall & Closet	Box	\$51	\$57	•	\$57	•	\$57	•	•	•	\$57	\$57	\$57
F40 Bed & Bath	Box	\$56	•	•	\$61	•	\$61	•	•	•	\$61	\$61	\$61
F51A Keyed Entry	Box	\$86	\$92	•	\$92	•	\$92	•	•	•	\$92	\$92	\$92
F80 Storeroom	Box	\$98	\$105	•	\$105	•	\$105	•	•	•	\$105	\$105	\$105
F170 Non-turning	Box	\$27	•	•	\$29	•	\$29	•	•	•	\$29	\$29	\$29

List Price Adders:

- Retail Package Options (highlighted) - add \$7.00 to list price.
- Retail Package in 622 finish comes in a Graphic Carton design.
- Decorative Trim Option - See chart on page 43.
- Triple Option Latch - add \$3.00 to list price; Box Pack Only.
- UL Latch - add \$7.00 to list price (F10, F51A, F80 Functions Box Pack Only).
- Split Design - use higher list price of two designs: Box Pack Only.
- Split Finish - add \$8.00 to higher list price of two finishes: Box Pack Only.

Stand out *effortlessly*.

Schlage's Decorative Collections offer thousands of additional design and finish combinations. See page 43 for details.



Broadway (BRW)



(BRW) Broadway

			FINISHES											
Function		Packaging	605	505	608	609	618	619	620	621	622	625	626	716
F10	Hall & Closet	Box/Vis	•	•	•	•	•	\$73	•	•	\$73	\$73	\$73	\$73
F40	Bed & Bath	Box/Vis	•	•	•	•	•	\$78	•	•	\$78	\$78	\$78	\$78
F51A	Keyed Entry	Box/Vis	•	•	•	•	•	\$133	•	•	\$133	\$133	\$133	\$133
F80	Storeroom	Box	•	•	•	•	•	\$144	•	•	\$144	\$144	\$144	\$144
F170	Non-turning	Box/Vis	•	•	•	•	•	\$39	•	•	\$39	\$39	\$39	\$39



Champagne (CHP)



(CHP) Champagne

			FINISHES											
Function		Packaging	605	505	608	609	618	619	620	621	622	625	626	716
F10	Hall & Closet	Box	•	•	•	•	•	\$91	•	•	•	•	•	\$91
F40	Bed & Bath	Box	•	•	•	•	•	\$97	•	•	•	•	•	\$97
F51A	Keyed Entry	Box	•	•	•	•	•	\$149	•	•	•	•	•	\$149
F80*	Storeroom	Box	•	•	•	•	•	\$162	•	•	•	•	•	\$162
F170*	Non-turning	Box	•	•	•	•	•	\$46	•	•	•	•	•	\$46

* Specify handing.

List Price Adders:

- Retail Package Options (highlighted) - add \$7.00 to list price.
- Decorative Trim Option - See chart on page 43.
- Triple Option Latch - add \$3.00 to list price; Box Pack Only.
- UL Latch - add \$7.00 to list price (F10, F51A, F80 Functions Box Pack Only).
- Split Design - use higher list price of two designs: Box Pack Only.
- Split Finish - add \$8.00 to higher list price of two finishes: Box Pack Only.



Davlin (DAV)



(DAV) Davlin

FINISHES

Function	Packaging	605	505	608	609	618	619	620	621	622	625	626	716	
F10	Hall & Closet	Box/Vis	•	•	\$73	•	•	\$73	•	•	\$73	\$73	•	\$73
F40	Bed & Bath	Box/Vis	•	•	\$78	•	•	\$78	•	•	\$78	\$78	•	\$78
F51A	Keyed Entry	Box/Vis	•	•	\$133	•	•	\$133	•	•	\$133	\$133	•	\$133
F80	Storeroom	Box	•	•	\$144	•	•	\$144	•	•	\$144	\$144	•	\$144
F170	Non-turning	Box	•	•	\$39	•	•	\$39	•	•	\$39	\$39	•	\$39



Delfayo (DEF)

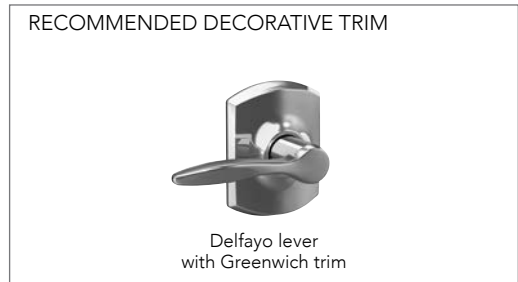

(DEL) Delfayo

FINISHES

Function	Packaging	605	505	608	609	618	619	620	621	622	625	626	716	
F10	Hall & Closet	Box/Vis	•	•	\$73	•	•	\$73	•	•	\$73	\$73	•	\$73
F40	Bed & Bath	Box/Vis	•	•	\$78	•	•	\$78	•	•	\$78	\$78	•	\$78
F51A	Keyed Entry	Box/Vis	•	•	\$133	•	•	\$133	•	•	\$133	\$133	•	\$133
F80*	Storeroom	Box	•	•	\$144	•	•	\$144	•	•	\$144	\$144	•	\$144
F170*	Non-turning	Box	•	•	\$39	•	•	\$39	•	•	\$39	\$39	•	\$39

* Specify handing.

List Price Adders:

- Retail Package Options (highlighted) - add \$7.00 to list price.
- Decorative Trim Option - See chart on page 43.
- Triple Option Latch - add \$3.00 to list price; Box Pack Only.
- UL Latch - add \$7.00 to list price (F10, F51A, F80 Functions Box Pack Only).
- Split Design - use higher list price of two designs: Box Pack Only.
- Split Finish - add \$8.00 to higher list price of two finishes: Box Pack Only.

Stand out *effortlessly*.

Schlage's Decorative Collections offer thousands of additional design and finish combinations. **See page 43 for details.**



Elan
(ELA)



(ELA) Elan

FINISHES

Function	Packaging	605	505	608	609	618	619	620	621	622	625	626	716
F10 Hall & Closet	Box	\$66	•	•	\$73	•	\$73	•	•	\$73	\$73	\$73	\$73
F40 Bed & Bath	Box	\$69	•	•	\$78	•	\$78	•	•	\$78	\$78	\$78	\$78
F51A Keyed Entry	Box	\$123	\$133	•	\$133	•	\$133	•	•	\$133	\$133	\$133	\$133
F80 Storeroom	Box	\$136	\$144	•	\$144	•	\$144	•	•	\$144	\$144	\$144	\$144
F170 Non-turning	Box	\$33	•	•	\$39	•	\$39	•	•	\$39	\$39	\$39	\$39

NOTE:

- 1) Elan F10, F40, F51A and F80 in 626 Finish are available as CSV - add \$13 to list price.
- 2) CSV - Contractor Series VisPack (Includes Light Commercial packaging and comes standard with UL fire rated latches.)



Flair
(FLA)



(FLA) Flair

FINISHES

Function	Packaging	605	505	608	609	618	619	620	621	622	625	626	716
F10 Hall & Closet	Box	\$66	\$73	\$73	\$73	•	\$73	\$73	•	\$73	\$73	\$73	\$73
F40 Bed & Bath	Box	\$69	•	\$78	\$78	•	\$78	\$78	•	\$78	\$78	\$78	\$78
F51A Keyed Entry	Box	\$123	\$133	\$133	\$133	•	\$133	\$133	•	\$133	\$133	\$133	\$133
F80* Storeroom	Box	\$136	\$144	\$144	\$144	•	\$144	\$144	•	\$144	\$144	\$144	\$144
F170* Non-turning	Box	\$33	•	\$39	\$39	•	\$39	\$39	•	\$39	\$39	\$39	\$39

* Specify handing.

List Price Adders:

- Retail Package Options (highlighted) - add \$7.00 to list price.
- Decorative Trim Option - See chart on page 43.
- Triple Option Latch - add \$3.00 to list price; Box Pack Only.
- UL Latch - add \$7.00 to list price (F10, F51A, F80 Functions Box Pack Only).
- Split Design - use higher list price of two designs: Box Pack Only.
- Split Finish - add \$8.00 to higher list price of two finishes: Box Pack Only.



Jazz
(JAZ)

(JAZ) Jazz

			FINISHES											
Function		Packaging	605	505	608	609	618	619	620	621	622	625	626	716
F10	Hall & Closet	Box	•	•	•	•	•	\$73	•	•	\$73	\$73	\$73	\$73
F40	Bed & Bath	Box	•	•	•	•	•	\$78	•	•	\$78	\$78	\$78	\$78
F51A	Keyed Entry	Box	•	•	•	•	•	•	•	•	•	•	•	•
F80	Storeroom	Box	•	•	•	•	•	•	•	•	•	•	•	•
F170	Non-turning	Box	•	•	•	•	•	\$39	•	•	\$39	\$39	\$39	\$39



Latitude
(LAT)

RECOMMENDED DECORATIVE TRIM

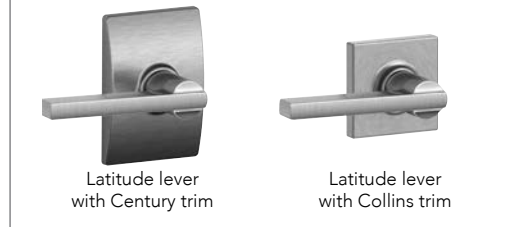

(LAT) Latitude

			FINISHES											
Function		Packaging	605	505	608	609	618	619	620	621	622	625	626	716
F10	Hall & Closet	Box /Vis	•	•	\$71	•	\$71	\$71	•	•	\$71	\$71	\$71	\$71
F40	Bed & Bath	Box /Vis	•	•	\$74	•	\$74	\$74	•	•	\$74	\$74	\$74	\$74
F51A	Keyed Entry	Box /Vis	•	•	\$133	•	\$133	\$133	•	•	\$133	\$133	\$133	\$133
F80	Storeroom	Box	•	•	\$144	•	\$144	\$144	•	•	\$144	\$144	\$144	\$144
F170	Non-turning	Box/Vis	•	•	\$37	•	\$37	\$37	•	•	\$37	\$37	\$37	\$37

List Price Adders:

- Retail Package Options (highlighted) - add \$7.00 to list price.
- Retail Package in 622 finish comes in a Graphic Carton design.
- Decorative Trim Option - See chart on page 43.
- Triple Option Latch - add \$3.00 to list price; Box Pack Only.
- UL Latch - add \$7.00 to list price (F10, F51A, F80 Functions Box Pack Only).
- Split Design - use higher list price of two designs: Box Pack Only.
- Split Finish - add \$8.00 to higher list price of two finishes: Box Pack Only.

Stand out *effortlessly*.

Schlage's Decorative Collections offer thousands of additional design and finish combinations. See page 43 for details.



Manhattan
(MNH)



(MNH) Manhattan

FINISHES

Function	Packaging	605	505	608	609	618	619	620	621	622	625	626	716
F10 Hall & Closet	Box/Vis	•	•	•	•	•	\$73	•	•	•	\$73	\$73	•
F40 Bed & Bath	Box/Vis	•	•	•	•	•	\$78	•	•	•	\$78	\$78	•
F51A Keyed Entry	Box/Vis	•	•	•	•	•	\$133	•	•	•	\$133	\$133	•
F80* Storeroom	Box	•	•	•	•	•	\$144	•	•	•	\$144	\$144	•
F170* Non-turning	Box	•	•	•	•	•	\$39	•	•	•	\$39	\$39	•

* Specify handing.



Merano
(MER)

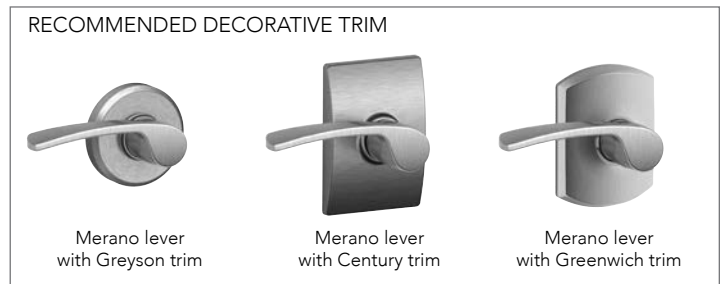

(MER) Merano

FINISHES

Function	Packaging	605	505	608	609	618	619	620	621	622	625	626	716
F10 Hall & Closet	Box/Vis	•	•	•	•	•	\$73	•	•	\$73	\$73	\$73	\$73
F40 Bed & Bath	Box/Vis	•	•	•	•	•	\$78	•	•	\$78	\$78	\$78	\$78
F51A Keyed Entry	Box/Vis	•	•	•	•	•	\$133	•	•	\$133	\$133	\$133	\$133
F80* Storeroom	Box	•	•	•	•	•	\$144	•	•	\$144	\$144	\$144	\$144
F170* Non-turning	Box/Vis	•	•	•	•	•	\$39	•	•	\$39	\$39	\$39	\$39

* Specify handing.

List Price Adders:

- Retail Package Options (highlighted) - add \$7.00 to list price.
- Decorative Trim Option - See chart on page 43.
- Triple Option Latch - add \$3.00 to list price; Box Pack Only.
- UL Latch - add \$7.00 to list price (F10, F51A, F80 Functions Box Pack Only).
- Split Design - use higher list price of two designs: Box Pack Only.
- Split Finish - add \$8.00 to higher list price of two finishes: Box Pack Only.

Stand out *effortlessly*.

Schlage's Decorative Collections offer thousands of additional design and finish combinations. **See page 43 for details.**

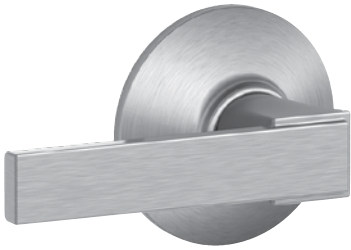

Northbrook
(NBK)



(NBK) Northbrook

FINISHES

Function	Packaging	605	505	608	609	618	619	620	621	622	625	626	716
F10 Hall & Closet	Box	•	•	•	•	•	\$73	•	•	•	•	•	•
F40 Bed & Bath	Box	•	•	•	•	•	\$78	•	•	•	•	•	•
F51A Keyed Entry	Box	•	•	•	•	•	\$133	•	•	\$133	\$133	•	\$133
F80 Storeroom	Box	•	•	•	•	•	\$144	•	•	•	•	•	•
F170 Non-turning	Box	•	•	•	•	•	\$39	•	•	•	•	•	•

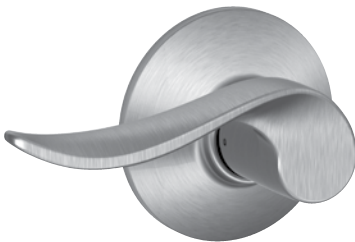

Sacramento
(SAC)



(SAC) Sacramento

FINISHES

Function	Packaging	605	505	608	609	618	619	620	621	622	625	626	716
F10 Hall & Closet	Box/Vis	•	•	•	•	\$57	\$57	•	•	•	\$57	\$57	\$57
F40 Bed & Bath	Box/Vis	•	•	•	•	\$61	\$61	•	•	•	\$61	\$61	\$61
F51A Keyed Entry	Box/Vis	•	•	•	•	\$92	\$92	•	•	•	\$92	\$92	\$92
F80* Storeroom	Box	•	•	•	•	\$105	\$105	•	•	•	\$105	\$105	\$105
F170* Non-turning	Box	•	•	•	•	\$29	\$29	•	•	•	\$29	\$29	\$29

* Specify handing.

List Price Adders:

- Retail Package Options (highlighted) - add \$7.00 to list price.
- Decorative Trim Option - See chart on page 43.
- Triple Option Latch - add \$3.00 to list price; Box Pack Only.
- UL Latch - add \$7.00 to list price (F10, F51A, F80 Functions Box Pack Only).
- Split Design - use higher list price of two designs: Box Pack Only.
- Split Finish - add \$8.00 to higher list price of two finishes: Box Pack Only.

SCHLAGE'S DECORATIVE COLLECTIONS

Stand out *effortlessly*.

Schlage's Decorative Collections make it easy to match our strength to your style. With more than 1,000 customized design and finish options in all, your decor will be limited by only your imagination.



Pair a knob or lever with our inspired decorative trim options to bring your vision to life.*

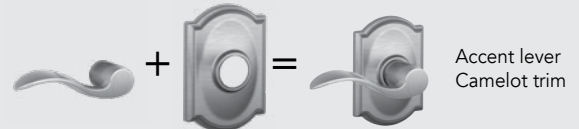

* Locks ship complete with trim attached



Addison (ADD)



Andover (AND)



Brookshire (BRK)



Camelot (CAM)



Century (CEN)



Collins (COL)



Greenwich (GRW)



Greyson (GSN)



Remsen (RMN)



Upland (ULD)

Follow these steps for pricing decorative combinations:

1. Locate the price of the standard knob or lever from the Knobs/Levers section.
2. Use the chart below to find the list price adder for the matching Decorative Collection upgrade.
3. Add the prices together for the total cost of the new combinations.

* Decorative trim are staked on the lock chassis for strength and durability and can only be ordered as a complete lock product.

FINISHES AVAILABLE

Decorative trim finish	605	505	608	609	618	619	620	621	622	625	626	716
Addison (ADD)	•	•	•	\$19	•	\$19	\$19	\$19	\$19	\$19	\$19	\$19
Andover (AND) ^{1, 2}	\$19	\$19	•	\$19	•	\$19	\$19	•	\$19	\$19	\$19	\$19
Brookshire (BRK)	\$19	\$19	•	\$19	•	\$19	•	•	\$19	•	•	\$19
Camelot (CAM)	\$19	\$19	\$19	\$19	•	\$19	\$19	•	\$19	\$19	•	\$19
Century (CEN)	•	•	\$19	•	\$19	\$19	•	•	\$19	\$19	\$19	\$19
Collins (COL)	•	•	\$19	•	•	\$19	•	•	\$19	\$19	•	\$19
Greenwich (GRW)	•	•	•	•	\$19	\$19	•	•	\$19	\$19	\$19	\$19
Greyson (GSN) ^{1, 2}	•	•	•	•	\$19	\$19	•	•	\$19	\$19	\$19	\$19
Remsen (RMN)	•	•	\$19	•	•	\$19	•	•	\$19	\$19	•	\$19
Upland (ULD) ³	•	•	•	•	•	\$19	•	•	•	•	•	•



EXAMPLE 1: To price a Accent passage lever with an Addison trim in Antique Pewter, take the price listed in the price book for the F10 ACC 620 and add the additional charge from the chart above.

\$71.00	(F10 ACC 620)
+ \$19.00	(Addison Decorative Trim 620)
\$90.00	Total cost
	(F10 ACC 620 ADD)

When ordering a decorative collection product, specify the trim at the end of the product code.
Example: F40 ACC 716 **CAM** or F170 LAT 625 **CEN**

NOTE: The deco trim cost for an F170 is 50% of the cost listed on this chart.
AND and GSN deco trim are not available for PLY or GEO styles.

¹ Greyson and Andover are not available in B60 or F59 functions.

² Greyson and Andover feature concealed screws.

³ ULD unavailable in B60 function. ULD F59 features COL deadbolt.

**To order
latches and strikes
see page 96-97**

**J Series Levers
AVAILABLE FUNCTIONS**

Non-keyed Locks

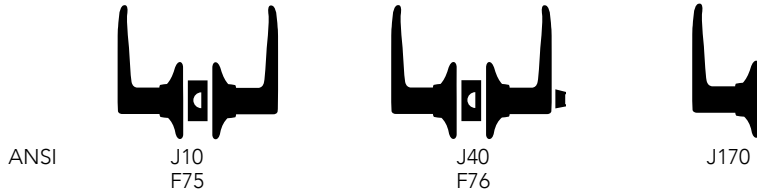

Keyed Locks

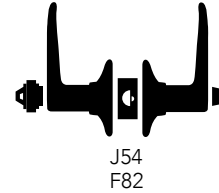

**ANSI/BHMA A156.2-2011 Commercial Grade 3
J Series Levers**

Non-keyed Locks

J10 (ANSI F75) - Hall & Closet

- Both levers always unlocked

J40 (ANSI F76) - Bed & Bath

- Turn-button locking. Can be opened from outside by turning outside turn mechanism
- From interior, turning inside turn-button releases inside lever

J40P - Bed & Bath (Pushbutton)

- Push-button locking. Can be opened from outside with small circular tool.
- Turning inside lever releases button
- ADA Compliant

J170 - Non-turning

- Non-turning trim for one side of door
- Used for door pull or as matching inactive trim

Keyed Locks

J54 (ANSI F82) - Keyed Entry

- Unlocked by key from outside when outer lever is locked by turn-button in inside lever
- Inside lever is locked and unlocked by turn-button

PRODUCT IDENTIFICATION

J	54	F	SEV	619	SQR	16-255	10-101	KA4
Lock Series	Product	UL Fire Rated	Design	Finish Code	Collins Trim	Latch	Strike	Keying

LATCHES & STRIKES

Keyed Latches - Dead Latches

- 16-255** - Triple Option (Round, Square, Drive-in) - **STANDARD**
- 16-061** - UL Listed 3 hour, Square Corner

Strikes

- 10-101** - Round Corner Full Lip - **STANDARD**

Non Keyed - Spring Latches

- 16-254** - Dual Option (Round, Drive-in) - **STANDARD**
- 16-059** - UL Listed 3 hour, Square Corner
- 16-070** - Triple Option Spring Latch for handlesets

STANDARD FEATURES / CONFIGURATIONS

J Series Levers	
	Description
Certification:	ANSI/BHMA A156.2-2011 Commercial Grade 3 Available option for UL Listed for 3 hour fire door (J10 and J54 functions only)
Latch:	Dual Option: 1" x 2-1/4", 1/4" round faceplate and drive-in Triple Option: 1" x 2-1/4", square corner and 1/4" round faceplate, drive-in latch (J54)
Strike:	1-5/8" x 2-1/4", radius corner, full lip, no box
Backset:	Adjustable for 2-3/8" or 2-3/4"
Cylinder:	5-pin, C keyway, Keyed Alike (KA4) Also available in Keyed Different (KD), Residential Construction Key (RCK) ¹ , Residential Master Key (RMK) ¹ , and commercial Master Key (MK)
Door Range:	1-3/8" – 1-3/4"
Keys:	Two 48-155 brass cut keys per lock, 5-pin, C section

¹ See pricing for RCK and RMK in Hardware & Accessories section.

FINISH CODES & DESCRIPTIONS

605	609	619	620	622	625	626	630	716
Bright Brass (US3)	Antique Brass (US5)	Satin Nickel (US15)	Antique Pewter (US15A)	Matte Black (US19)	Bright Chrome (US26)	Satin Chrome (US26D)	Satin Stainless Steel (US32D)	Aged Bronze

Non-standard finishes are not available.

PACKAGING & CARTON SPECS

	INDIVIDUAL CARTON				SHIPPER					
	CARTON WEIGHT	HEIGHT	WIDTH	DEPTH	QTY. SHIPPER	CARTON WEIGHT	CU. FT.	HEIGHT	WIDTH	DEPTH
Levers										
J10	1.58	3.07 in.	5.71 in.	6.69 in.	16	37.84	2.143	14.8 in.	13.7 in.	18.3 in.
J40	1.58	3.07 in.	5.71 in.	6.69 in.	16	37.84	2.143	14.8 in.	13.7 in.	18.3 in.
J54	1.58	3.07 in.	5.71 in.	6.69 in.	16	37.84	2.143	14.8 in.	13.7 in.	18.3 in.
J170	0.56	2.44 in.	2.64 in.	5.43 in.	50	28.16	1.420	12.2 in.	13.7 in.	14.7 in.
J10F	1.58	3.07 in.	5.71 in.	6.69 in.	16	37.84	2.143	14.8 in.	13.7 in.	18.3 in.
J54F	1.58	3.07 in.	5.71 in.	6.69 in.	16	37.84	2.143	14.8 in.	13.7 in.	18.3 in.

For Vis Pack carton specs, see page 106.



J10
Broadway (BRW)

(BRW) Broadway

FINISHES

Function	Packaging	605	609	619	620	622	625	626	630	716
J10 Hall & Closet	Box	•	•	\$55	•	\$55	\$55	\$55	•	\$55
J40 Bed & Bath	Box	•	•	\$62	•	\$62	\$62	\$62	•	\$62
J54 Keyed Entry	Box	•	•	\$75	•	\$75	\$75	\$75	•	\$75
J170 Non-turning	Box	•	•	\$30	•	\$30	\$30	\$30	•	\$30



J10
Broadway with
Collins Trim (BRW/COL)

(BRW/SQR) Broadway with Collins Rose

FINISHES

Function	Packaging	605	609	619	620	622	625	626	630	716
J10 Hall & Closet	Box	•	•	\$67	•	\$67	\$67	\$67	•	\$67
J40 Bed & Bath	Box	•	•	\$70	•	\$70	\$70	\$70	•	\$70
J54 Keyed Entry	Box	•	•	\$87	•	\$87	\$87	\$87	•	\$87
J170 Non-turning	Box	•	•	\$35	•	\$35	\$35	\$35	•	\$35



J10
Dover (DOV)

(DOV) Dover

FINISHES

Function	Packaging	605	609	619	620	622	625	626	630	716
J10 Hall & Closet	Box/Vis	•	•	\$51	•	\$51	\$51	\$51	\$51	\$51
J40 Bed & Bath	Box/Vis	•	•	\$57	•	\$57	\$57	\$57	\$57	\$57
J54 Keyed Entry	Box/Vis	•	•	\$79	•	\$79	\$79	\$79	\$79	\$79
J170 Non-turning	Box/Vis	•	•	\$28	•	\$28	\$28	\$28	\$28	\$28

List Price Adders:

Visual Package Options (highlighted) - add \$5.00 to list price.

UL Latch - add \$7.00 to list price. (J10F, J54F)

* Specify handing.

NOTE:

1) J10 and J40 standard latch is Dual Option (Round, Drive-in)

2) J54 standard latch is Triple Option (Round, Square, Drive-in)



J10
LaSalle (LAS)

(LAS) LaSalle

FINISHES

Function	Packaging	605	609	619	620	622	625	626	630	716
J10 Hall & Closet	Box/Vis	\$51	\$51	\$51	•	•	•	•	•	\$51
J40 Bed & Bath	Box/Vis	\$57	\$57	\$57	•	•	•	•	•	\$57
J54 Keyed Entry	Box/Vis	\$79	\$79	\$79	•	•	•	•	•	\$79
J170* Non-turning	Box/Vis	\$28	\$28	\$28	•	•	•	•	•	\$28



J10
Marin (MAR)

(MAR) Marin

FINISHES

Function	Packaging	605	609	619	620	622	625	626	630	716
J10 Hall & Closet	Box	•	•	\$51	•	\$51	\$51	\$51	\$51	\$51
J40 Bed & Bath	Box	•	•	\$57	•	\$57	\$57	\$57	\$57	\$57
J54 Keyed Entry	Box	•	•	\$79	•	\$79	\$79	\$79	\$79	\$79
J170 Non-turning	Box	•	•	\$28	•	\$28	\$28	\$28	\$28	\$28



J10
Seville (SEV)

(SEV) Seville

FINISHES

Function	Packaging	605	609	619	620	622	625	626	630	716
J10 Hall & Closet	Box/Vis	•	•	\$51	•	\$51	\$51	•	•	\$51
J40 Bed & Bath	Box/Vis	•	•	\$57	•	\$57	\$57	•	•	\$57
J54 Keyed Entry	Box/Vis	•	•	\$79	•	\$79	\$79	•	•	\$79
J170* Non-turning	Box/Vis	•	•	\$28	•	\$28	\$28	•	•	\$28
J40P Bed & Bath	Box	•	•	\$59	•	•	\$59	•	•	\$59

List Price Adders:

Visual Package Options (highlighted) - add \$5.00 to list price.
UL Latch - add \$7.00 to list price. (J10F, J54F)

* Specify handing.

NOTE:

- 1) J10 and J40 standard latch is Dual Option (Round, Drive-in)
- 2) J54 standard latch is Triple Option (Round, Square, Drive-in)



J10
Solstice (SOL)

(SOL) Solstice

FINISHES

Function	Packaging	605	609	619	620	622	625	626	630	716
J10 Hall & Closet	Box/Vis	•	•	\$55	•	\$55	\$55	\$55	•	\$55
J40 Bed & Bath	Box/Vis	•	•	\$62	•	\$62	\$62	\$62	•	\$62
J54 Keyed Entry	Box/Vis	•	•	\$75	•	\$75	\$75	\$75	•	\$75
J170 Non-turning	Box/Vis	•	•	\$30	•	\$30	\$30	\$30	•	\$30
J40P Bed & Bath	Box	•	•	\$64	•	•	\$64	•	•	\$64

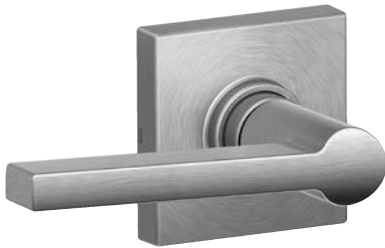

J10
Solstice with
Collins Trim (SOL/COL)

(SOL/SQR) Solstice with Collins Rose

FINISHES

Function	Packaging	605	609	619	620	622	625	626	630	716
J10 Hall & Closet	Box/Vis	•	•	\$67	•	\$67	\$67	\$67	•	\$67
J40 Bed & Bath	Box/Vis	•	•	\$70	•	\$70	\$70	\$70	•	\$70
J54 Keyed Entry	Box/Vis	•	•	\$87	•	\$87	\$87	\$87	•	\$87
J170 Non-turning	Box	•	•	\$35	•	\$35	\$35	\$35	•	\$35



J10
Torino (TOR)

(TOR) Torino

FINISHES

Function	Packaging	605	609	619	620	622	625	626	630	716
J10 Hall & Closet	Box/Vis	•	•	\$51	\$51	•	\$51	•	\$51	\$51
J40 Bed & Bath	Box/Vis	•	•	\$57	\$57	•	\$57	•	\$57	\$57
J54 Keyed Entry	Box/Vis	•	•	\$79	\$79	•	\$79	•	\$79	\$79
J170 Non-turning	Box/Vis	•	•	\$28	\$28	•	\$28	•	\$28	\$28
J40P Bed & Bath	Box	•	•	\$59	•	•	\$59	•	•	\$59

List Price Adders:

Visual Package Options (highlighted) - add \$5.00 to list price.

UL Latch - add \$7.00 to list price. (J10F, J54F)

* Specify handing.

NOTE:

1) J10 and J40 standard latch is Dual Option (Round, Drive-in)

2) J54 standard latch is Triple Option (Round, Square, Drive-in)



Notes

F Series	50
F Series Decorative collection	57
J Series	58

F Series Knobs

AVAILABLE FUNCTIONS

Non-keyed Locks



Schlage
ANSI

F10
F75





F40
F76



F170

ANSI/BHMA A156.2-2017 Commercial Grade 2
ANSI/BHMA A156.39-2015 Residential Grade AAA

Non-keyed Locks

-  **F10 (ANSI F75) – Hall & Closet**
 - Both knobs/levers always unlocked
-  **F40 (ANSI F76) – Bed & Bath**
 - Push-button locking
 - Can be opened from outside with small circular tool
 - Turning inside knob/lever releases button
-  **F170 – Non-turning**
 - Non-turning trim for one side of door
 - Used for door pull or as matching inactive trim

Keyed Locks





F51A
F81



F80
F86

Keyed Locks

-  **F51A (ANSI F81) – Keyed Entry**
 - Keyed entry function unlocks when door is opened from the inside, allowing you to leave quickly, conveniently and re-enter easily
 - Locked by inserting key and rotating cylinder from outside, or manually rotating interior turn-button after exit
-  **F80 (ANSI F86) – Storeroom Lock**
 - Outside knob/lever fixed. Entrance by key only.
 - Inside knob/lever always unlocked

PRODUCT IDENTIFICATION

F	51A	F	PLY	619	CAM	RH	16-086	10-027	KA4
Lock Series	Product	UL Fire Rated (V - VisPack) (G - Graphic Cover)	Style	Finish Code	Decorative Trim	Hand	Latch	Strike	Keying

LATCHES & STRIKES

- Keyed Latches - Dead Latches**
- 16-086** - Dual Option (Round, Drive-in) **STANDARD**
 - 16-207** - Square Corner
 - 16-211** - Triple Option (Round, Square, Drive-in)
 - 16-203** - UL Listed Square Corner with Firecup
 - 16-204** - UL Listed Round Corner with Firecup
 - 16-126** - 5" Backset, Square Corner

- Non Keyed - Spring Latches**
- 16-080** -Dual Option (Round, Drive-in) **STANDARD**
 - 16-200** -Square Corner
 - 16-210** -Triple Option (Round, Square, Drive-in)
 - 16-203** -UL Listed Square Corner with Firecup
 - 16-204** -UL Listed Round Corner with Firecup
 - 16-126** -5" Backset, Square Corner

- Strikes**
- 10-027** - Round Corner Full Lip **STANDARD**
 - 10-001** - Square Corner T Strike
 - 10-026** - Square Corner Full Lip
 - 10-058** - Circular - Adjustable
 - 10-063** - Dual Strikes (Round & Square Full Lip)
 - 10-025** - ANSI Square Corner

STANDARD FEATURES / CONFIGURATIONS

F Series Knobs/Decorative Trim¹	
	Description
Certification:	ANSI/BHMA A156.2-2017 Commercial Grade 2 ANSI/BHMA A156.39-2015 Residential Grade AAA Available UL Listed for 3-hour fire door (F10, F40 (CSV Only), F51A, F80 functions)
Latch:	1" x 2-1/4", 1/4" radius corner faceplate, 7/8" housing diameter, 1/2" throw, circular drive-in included, universal latch
Strike:	1-5/8" x 2-1/4" radius corner, full lip, no box
Backset:	Dual backset latches, fits either 2-3/8" or 2-3/4" backsets
Cylinder:	5-Pin, C keyway, Keyed Alike (KA4) Also available in Keyed Different (KD), Residential Construction Key (RCK) ² , Residential Master Key (RMK) ² , and commercial Master Key (MK)
Door Range:	1-3/8" – 1-3/4"
Keys:	Two 48-180 keys per lock, 5-pin, C section

¹ Locks are furnished with standard features unless otherwise specified. To order locks with non-standard features, specify non-standard feature desired.
² See pricing for RCK and RMK in Hardware & Accessories section.

FINISH CODES & DESCRIPTIONS

505	605	608	609	618	619	620	621	622	625	626	716
Lifetime Bright Brass	Bright Brass (US3)	Satin Brass	Antique Brass (US5)	Polished Nickel	Satin Nickel (US15)	Antique Pewter (US15A)	Distressed Nickel	Matte Black (US19)	Bright Chrome (US26)	Satin Chrome (US26D)	Aged Bronze

Non-standard finishes are not available.

PACKAGING & CARTON SPECS

	INDIVIDUAL CARTON				SHIPPER						
	CARTON WEIGHT	HEIGHT	WIDTH	DEPTH	QTY. SHIPPER	CARTON WEIGHT	CU. FT.	HEIGHT	WIDTH	DEPTH	
Knobs											
F10	1.55	3.06 in.	4.37 in.	8.14 in.	20	31.00	1.520	9.0 in.	15.6 in.	18.8 in.	
F40	1.55	3.06 in.	4.37 in.	8.14 in.	20	31.00	1.520	9.0 in.	15.6 in.	18.8 in.	
F51A	1.55	3.06 in.	4.37 in.	8.14 in.	20	31.00	1.520	9.0 in.	15.6 in.	18.8 in.	
F80	1.55	3.06 in.	4.37 in.	8.14 in.	20	31.00	1.520	9.0 in.	15.6 in.	18.8 in.	
F170	0.45	2.77 in.	3.60 in.	3.88 in.	20	9.00	0.575	4.8 in.	14.5 in.	15.0 in.	
Decorative Collections Knobs											
All Knobs*	1.55	3.25 in.	6.00 in.	7.00 in.	8	15.00	1.090	8.13 in.	12.63 in.	18.4 in.	
F170	1.20	2.86 in.	4.38 in.	5.66 in.	20	25.00	1.000	6.5 in.	15.3 in.	18.3 in.	

For Retail Pack carton specs, see page 106.

* AND Decorative knobs use same cartons as the Standard Knobs in first table above.

AVAILABLE STYLES



Andover
(AND)



Bell
(BEL)



Bowery
(BWE)



Georgian
(GEO)



Orbit
(ORB)



Plymouth
(PLY)



Siena
(SIE)



Andover
(AND)



(AND) Andover

FINISHES

Function	Packaging	605	505	608	609	618	619	620	621	622	625	626	716
F10 Hall & Closet	Box	\$51	\$54	•	\$54	•	\$54	\$54	•	•	\$54	\$54	\$54
F40 Bed & Bath	Box	\$56	•	•	\$58	•	\$58	\$58	•	•	\$58	\$58	\$58
F51A Keyed Entry	Box	\$77	\$82	•	\$82	•	\$82	\$82	•	•	\$82	\$82	\$82
F80 Storeroom	Box	\$89	\$94	•	\$94	•	\$94	\$94	•	•	\$94	\$94	\$94
F170 Non-turning	Box	\$27	•	•	\$28	•	\$28	\$28	•	•	\$28	\$28	\$28



Bell
(BEL)

(BEL) Bell

FINISHES

Function	Packaging	605	505	608	609	618	619	620	621	622	625	626	716
F10 Hall & Closet	Box/Vis	\$40	\$42	•	\$42	•	•	•	•	•	•	\$42	•
F40 Bed & Bath	Box/Vis	\$43	•	•	\$45	•	•	•	•	•	•	\$45	•
F51A Keyed Entry	Box/Vis	\$65	\$69	•	\$69	•	•	•	•	•	•	\$69	•
F80 Storeroom	Box	\$77	\$82	•	\$82	•	•	•	•	•	•	\$82	•
F170 Non-turning	Box/Vis	\$19	•	•	\$22	•	•	•	•	•	•	\$22	•

List Price Adders:

- Retail Package Options (highlighted) - add \$7.00 to list price.
- Decorative Trim Option - See chart on page 57.
- Triple Option Latch - add \$3.00 to list price; Box Pack Only.
- UL Latch - add \$7.00 to list price (F10, F51A, F80 Functions Box Pack Only).
- Split Design - use higher list price of two designs: Box Pack Only.
- Split Finish - add \$8.00 to higher list price of two finishes: Box Pack Only.



Bowery (BWE)

(BWE) Bowery

			FINISHES											
Function		Packaging	605	505	608	609	618	619	620	621	622	625	626	716
F10	Hall & Closet	Box/Vis	•	•	\$54	•	\$54	\$54	•	•	\$54	\$54	\$54	\$54
F40	Bed & Bath	Box/Vis	•	•	\$58	•	\$58	\$58	•	•	\$58	\$58	\$58	\$58
F51A	Keyed Entry	Box/Vis	•	•	\$82	•	\$82	\$82	•	•	\$82	\$82	\$82	\$82
F80	Storeroom	Box	•	•	\$94	•	\$94	\$94	•	•	\$94	\$94	\$94	\$94
F170	Non-turning	Box	•	•	\$28	•	\$28	\$28	•	•	\$28	\$28	\$28	\$28

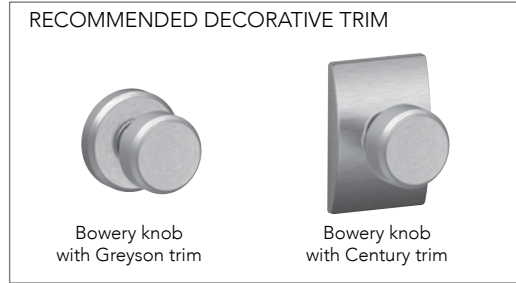

Georgian (GEO)

(GEO) Georgian

			FINISHES											
Function		Packaging	605	505	608	609	618	619	620	621	622	625	626	716
F10	Hall & Closet	Box/Vis	\$40	\$42	\$42	\$42	•	\$42	\$42	\$42	\$42	\$42	•	\$42
F40	Bed & Bath	Box/Vis	\$43	•	\$45	\$45	•	\$45	\$45	\$45	\$45	\$45	•	\$45
F51A	Keyed Entry	Box/Vis	\$65	\$69	\$69	\$69	•	\$69	\$69	\$69	\$69	\$69	•	\$69
F80	Storeroom	Box	\$77	\$82	\$82	\$82	•	\$82	\$82	\$82	\$82	\$82	•	\$82
F170	Non-turning	Box/Vis	\$19	•	\$22	\$22	•	\$22	\$22	\$22	\$22	\$22	•	\$22

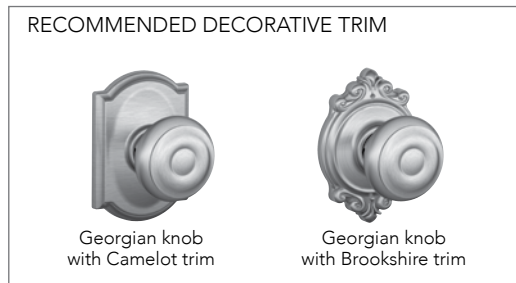

List Price Adders:

- Retail Package Options (highlighted) - add \$7.00 to list price.
- Decorative Trim Option - See chart on page 57.
- Triple Option Latch - add \$3.00 to list price; Box Pack Only.
- UL Latch - add \$7.00 to list price (F10, F51A, F80 Functions Box Pack Only).
- Split Design - use higher list price of two designs: Box Pack Only.
- Split Finish - add \$8.00 to higher list price of two finishes: Box Pack Only.

Stand out *effortlessly*.

Schlage's Decorative Collections offer thousands of additional design and finish combinations. **See page 57 for details.**



Orbit (ORB)

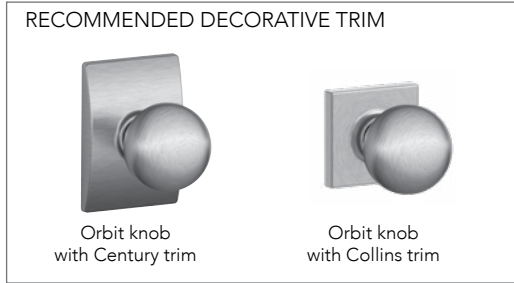

(ORB) Orbit

FINISHES

Function	Packaging	605	505	608	609	618	619	620	621	622	625	626	716
F10 Hall & Closet	Box/Vis	\$51	\$54	•	•	•	\$54	•	•	•	\$54	\$54	•
F40 Bed & Bath	Box/Vis	\$56	•	•	•	•	\$58	•	•	•	\$58	\$58	•
F51A Keyed Entry	Box/Vis	\$77	\$82	•	•	•	\$82	•	•	•	\$82	\$82	•
F80 Storeroom	Box	\$89	\$94	•	•	•	\$94	•	•	•	\$94	\$94	•
F170 Non-turning	Box/Vis	\$27	•	•	•	•	\$28	•	•	•	\$28	\$28	•

Note: 1) Orbit F10, F40, F51A and F80 in 626 Finish are available as CSV - add \$13.00 to list price.
 2) CSV - Contractor Series VisPack (Includes Light Commercial packaging and comes standard with UL fire rated latches.)



Plymouth (PLY)

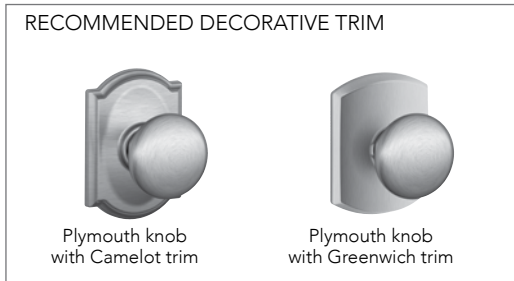

(PLY) Plymouth

FINISHES

Function	Packaging	605	505	608	609	618	619	620	621	622	625	626	716
F10 Hall & Closet	Box/Vis	\$40	\$42	•	\$42	•	\$42	\$42	•	\$42	\$42	\$42	\$42
F40 Bed & Bath	Box/Vis	\$43	•	•	\$45	•	\$45	\$45	•	\$45	\$45	\$45	\$45
F51A Keyed Entry	Box/Vis	\$65	\$69	•	\$69	•	\$69	\$69	•	\$69	\$69	\$69	\$69
F80 Storeroom	Box	\$77	\$82	•	\$82	•	\$82	\$82	•	\$82	\$82	\$82	\$82
F170 Non-turning	Box/Vis	\$19	•	•	\$22	•	\$22	\$22	•	\$22	\$22	\$22	\$22

List Price Adders:

- Retail Package Options (highlighted) - add \$7.00 to list price.
- Retail Package in 622 finish comes in a Graphic Carton design.
- Decorative Trim Option - See chart on page 57.
- Triple Option Latch - add \$3.00 to list price; Box Pack Only.
- UL Latch - add \$7.00 to list price (F10, F51A, F80 Functions Box Pack Only).
- Split Design - use higher list price of two designs: Box Pack Only.
- Split Finish - add \$8.00 to higher list price of two finishes: Box Pack Only.



Siena
(SIE)



(SIE) Siena

FINISHES

Function	Packaging	605	505	608	609	618	619	620	621	622	625	626	716
F10	Hall & Closet	Box	\$52	\$64	•	\$64	•	\$64	\$64	•	\$64	\$64	\$64
F40	Bed & Bath	Box	\$57	•	•	\$68	•	\$68	\$68	•	\$68	\$68	\$68
F51A	Keyed Entry	Box	\$74	\$85	•	\$85	•	\$85	\$85	•	\$85	\$85	\$85
F80	Storeroom	Box	\$87	\$97	•	\$97	•	\$97	\$97	•	\$97	\$97	\$97
F170	Non-turning	Box	\$28	•	•	\$33	•	\$33	\$33	•	\$33	\$33	\$33

Note: Siena 626, 605, and 505 knobs available while supplies last.

List Price Adders:

- Retail Package Options (highlighted) - add \$7.00 to list price.
- Decorative Trim Option - See chart on page 57.
- Triple Option Latch - add \$3.00 to list price; Box Pack Only.
- UL Latch - add \$7.00 to list price (F10, F51A, F80 Functions Box Pack Only).
- Split Design - use higher list price of two designs: Box Pack Only.
- Split Finish - add \$8.00 to higher list price of two finishes: Box Pack Only.

Stand out *effortlessly.*

Schlage's Decorative Collections offer thousands of additional design and finish combinations. **See page 57 for details.**

SCHLAGE'S DECORATIVE COLLECTIONS

Stand out *effortlessly*.

Schlage's Decorative Collections make it easy to match our strength to your style. With more than 1,000 customized design and finish options in all, your decor will be limited by only your imagination.



Pair a knob or lever with our inspired decorative trim options to bring your vision to life.*

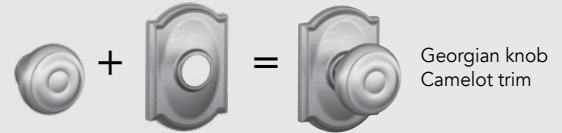

* Locks ship complete with trim attached



Addison (ADD)



Andover (AND)



Brookshire (BRK)



Camelot (CAM)



Century (CEN)



Collins (COL)



Greenwich (GRW)



Greyson (GSN)



Remsen (RMN)



Upland (ULD)

Follow these steps for pricing decorative combinations:

1. Locate the price of the standard knob or lever from the Knobs/Levers section.
2. Use the chart below to find the list price adder for the matching Decorative Collection upgrade.
3. Add the prices together for the total cost of the new combinations.

* Decorative trim are staked on the lock chassis for strength and durability and can only be ordered as a complete lock product.

FINISHES AVAILABLE

Decorative trim finish	605	505	608	609	618	619	620	621	622	625	626	716
Addison (ADD)	•	•	•	\$19	•	\$19	\$19	\$19	\$19	\$19	\$19	\$19
Andover (AND) ¹	\$19	\$19	•	\$19	•	\$19	\$19	•	\$19	\$19	\$19	\$19
Brookshire (BRK)	\$19	\$19	•	\$19	•	\$19	•	•	\$19	•	•	\$19
Camelot (CAM)	\$19	\$19	\$19	\$19	•	\$19	\$19	•	\$19	\$19	•	\$19
Century (CEN)	•	•	\$19	•	\$19	\$19	•	•	\$19	\$19	\$19	\$19
Collins (COL)	•	•	\$19	•	•	\$19	•	•	\$19	\$19	•	\$19
Greenwich (GRW)	•	•	•	•	\$19	\$19	•	•	\$19	\$19	\$19	\$19
Greyson (GSN) ¹	•	•	•	•	\$19	\$19	•	•	\$19	\$19	\$19	\$19
Remsen (RMN)	•	•	\$19	•	•	\$19	•	•	\$19	\$19	•	\$19
Upland (ULD) ²	•	•	•	•	•	\$19	•	•	•	•	•	•



EXAMPLE 1: To price a Siena passage knob with an Addison trim in Antique Pewter, take the price listed in the price book for the F10 SIE 620 and add the additional charge from the chart above.

\$64.00	(F10 SIE 620)
+ \$19.00	(Addison Decorative Trim 620)
\$83.00	Total cost
	(F10 SIE 620 ADD)

When ordering a decorative collection product, specify the trim at the end of the product code
 Example: F40 ACC 716 **CAM** or F170 LAT 625 **CEN**

NOTE: The deco trim cost for an F170 is 50% of the cost listed on this chart.
 AND and GSN deco trim are not available for PLY or GEO styles.

¹ Greyson and Andover are not available in B60 or F59 functions. Greyson and Andover feature concealed screws and are not available with BEL, GEO, PLY, and ORB knobs.

² ULD unavailable in B60 function. ULD F59 features COL deadbolt.

To order latches and strikes see page 96-97

J Series Knobs
AVAILABLE FUNCTIONS

Non-keyed Locks



ANSI J10 F75



J40 F76



J170

Keyed Locks



J54 F82

ANSI/BHMA A156.2-2011 Commercial Grade 3

Non-keyed Locks

J10 (ANSI F75) - Hall & Closet

- Both knobs always unlocked

J40 (ANSI F76) - Bed & Bath

- Turn-button locking. Can be opened from outside by turning outside turn mechanism
- From interior, turning inside turn-button releases inside knob

J170 - Non-turning

- Inactive trim for one side of door
- Used for door pull or as matching inactive trim

Keyed Locks

J54 (ANSI F82) - Keyed Entry

- Unlocked by key from outside when outer knob is locked by turn-button in inside knob
- Inside knob is locked and unlocked by turn-button

PRODUCT IDENTIFICATION

J	54	F	BYR	619	16-255	10-101	KA4
Lock Series	Product	UL Fire Rated	Design	Finish Code	Latch	Strike	Keying

LATCHES & STRIKES

Keyed Latches - Dead Latches

- 16-255** -Triple Option (Round, Square, Drive-in) - **STANDARD**
- 16-061** -UL Listed 3 Hour, Square Corner

Strikes

- 10-101** -Round Corner Full Lip - **STANDARD**

Non Keyed - Spring Latches

- 16-254** -Dual Option (Round, Drive-in) - **STANDARD**
- 16-059** -UL Listed 3 Hour, Square Corner
- 16-070** -Triple Option Spring Latch for handlesets

STANDARD FEATURES / CONFIGURATIONS

J Series Knobs	
	Description
Certification:	ANSI/BHMA A156.2-2011 Commercial Grade 3 Available option for UL Listed for 3 hour fire door (J10 and J54 functions)
Latch:	Dual Option: 1" x 2-1/4", 1/4" round faceplate and drive-in Triple Option: 1" x 2-1/4", square corner and 1/4" round faceplate, drive-in latch (J54)
Strike:	1-5/8" x 2-1/4", radius corner, full lip, no box
Backset:	Adjustable for 2-3/8" or 2-3/4"
Cylinder:	5-pin, C keyway, Keyed Alike (KA4) Also available in Keyed Different (KD), Residential Construction Key (RCK) ¹ , Residential Master Key (RMK) ¹ , and commercial Master Key (MK)
Door Range:	1-3/8" – 1-3/4"
Keys:	Two 48-155 brass cut keys per lock, 5-pin, C section

¹ See pricing for RCK and RMK in Hardware & Accessories section.

FINISH CODES & DESCRIPTIONS

605	609	619	620	622	625	626	630	716
Bright Brass (US3)	Antique Brass (US5)	Satin Nickel (US15)	Antique Pewter (US15A)	Matte Black (US19)	Bright Chrome (US26)	Satin Chrome (US26D)	Satin Stainless Steel (US32D)	Aged Bronze

Non-standard finishes are not available.

PACKAGING & CARTON SPECS

	INDIVIDUAL CARTON				SHIPPER					
	CARTON WEIGHT	HEIGHT	WIDTH	DEPTH	QTY. SHIPPER	CARTON WEIGHT	CU. FT.	HEIGHT	WIDTH	DEPTH
Knobs										
J10	1.04	2.76 in.	3.23 in.	6.77 in.	16	24.86	1.175	15.0 in.	10.9 in.	12.4 in.
J40	1.04	2.76 in.	3.23 in.	6.77 in.	16	24.86	1.175	15.0 in.	10.9 in.	12.4 in.
J54	1.04	2.76 in.	3.23 in.	6.77 in.	16	24.86	1.175	15.0 in.	10.9 in.	12.4 in.
J170	0.34	3.03 in.	2.60 in.	2.68 in.	50	16.94	0.923	7.6 in.	14.4 in.	14.6 in.
J10F	1.04	2.76 in.	3.23 in.	6.77 in.	16	24.86	1.175	15.0 in.	10.9 in.	12.4 in.
J54F	1.04	2.76 in.	3.23 in.	6.77 in.	16	24.86	1.175	15.0 in.	10.9 in.	12.4 in.

For Vis Pack carton specs, see page 106.
Note: Corona J10 functions are in shipper quantities of 24.



J10
Byron (BYR)

(BYR) Byron

Function	Packaging	FINISHES								
		605	609	619	620	622	625	626	630	716
J10 Hall & Closet	Box/Vis	\$34		•	•	•	•	•	\$34	•
J40 Bed & Bath	Box/Vis	\$39		•	•	•	•	•	\$39	•
J54 Keyed Entry	Box/Vis	\$49		•	•	•	•	•	\$49	•
J170 Non-turning	Box/Vis	\$18		•	•	•	•	•	\$18	•



J10
Corona (CNA)

(CNA) Corona

Function	Packaging	FINISHES								
		605	609	619	620	622	625	626	630	716
J10 Hall & Closet	Box/Vis	\$34	\$34	\$34	\$34	•	\$34	•	\$34	\$34
J40 Bed & Bath	Box/Vis	\$39	\$39	\$39	\$39	•	\$39	•	\$39	\$39
J54 Keyed Entry	Box/Vis	\$49	\$49	\$49	\$49	•	\$49	•	\$49	\$49
J170 Non-turning	Box/Vis	\$18	\$18	\$18	\$18	•	\$18	•	\$18	\$18



J10
Dublin (DUB)

(DUB) Dublin

Function	Packaging	FINISHES								
		605	609	619	620	622	625	626	630	716
J10 Hall & Closet	Box	•	•	\$34	•	•	•	•	•	\$34
J40 Bed & Bath	Box	•	•	\$39	•	•	•	•	•	\$39
J54 Keyed Entry	Box	•	•	\$49	•	•	•	•	•	\$49
J170 Non-turning	Box	•	•	\$18	•	•	•	•	•	\$18

List Price Adders:

Visual Package Options (highlighted) - add \$5.00 to list price.
UL Latch - add \$7.00 to list price. (J10F, J54F)

NOTE:

1) J10 and J40 standard latch is Dual Option (Round, Drive-in)
2) J54 standard latch is Triple Option (Round, Square, Drive-in)



J10
Stratus (STR)

(STR) Stratus

FINISHES

Function		Packaging	605	609	619	620	622	625	626	630	716
J10	Hall & Closet	Box/Vis	\$34	•	\$34	•	\$34	\$34	•	\$34	\$34
J40	Bed & Bath	Box/Vis	\$39	•	\$39	•	\$39	\$39	•	\$39	\$39
J54	Keyed Entry	Box/Vis	\$49	•	\$49	•	\$49	\$49	•	\$49	\$49
J170	Non-turning	Box/Vis	\$18	•	\$18	•	\$18	\$18	•	\$18	\$18

List Price Adders:

Visual Package Options (highlighted) - add \$5.00 to list price.
UL Latch - add \$7.00 to list price. (J10F, J54F)

NOTE:

1) J10 and J40 standard latch is Dual Option (Round, Drive-in)
2) J54 standard latch is Triple Option (Round, Square, Drive-in)

B Series	62
B Series Decorative collection	65
J Series	67

**B Series Deadbolts
AVAILABLE FUNCTIONS**



Schlage
ANSI



B60
E2152



B62
E2142



B80
E2192

B81

**ANSI/BHMA A156.36-2016 Commercial Grade 1
ANSI/BHMA A156.40-2015 Residential Grade AAA**

B80 and B81 are not graded.

B60 / E2152 - Single Cylinder Deadbolt Lock

- Deadbolt thrown or retracted by key from outside or by inside turn unit
- Bolt automatically deadlocks when fully thrown

B62 / E2142 - Double Cylinder Deadbolt Lock*

- Deadbolt thrown or retracted by key from either side
- Bolt automatically deadlocks when fully thrown

B80 / E2192 - One-Sided Deadbolt

- Deadbolt thrown or retracted from interior side only
- No exterior plate or exposed trim
- Non-graded

B81 - One-sided Deadbolt with Exterior Plate

- Deadbolt thrown or retracted from interior side only
- Exterior plate covers exposed prep on outside
- Non-graded

***Caution.** Double cylinder locks on residences and any door in any structure which is used for egress are a life safety hazard in times of emergency and their use is not recommended. Installation should be in accordance with existing codes only.

Note: Double cylinder locks are not available as UL Listed.

PRODUCT IDENTIFICATION

B	60	F	CAM	619	12-321	10-116	KA4
Lock Series	Product	UL Fire Rated (G - Graphic Cover)	Decorative Trim	Finish Code	Latch	Strike	Keying

LATCHES & STRIKES

Latches

- 12-321** -Dual Option (Round, Drive-in) - **STANDARD**
- 12-288** -Square Corner
- 12-287** -Triple Option (Round, Square, Drive-in)
- 12-294** -UL Listed Square Corner with Firecup
- 12-397** -UL Listed Round Corner with Firecup
- 12-355** - Tapered Deadbolt Triple Option (Round, Square, Drive-in)

Strikes

- 10-116** -Round Corner Integrated Strike and Reinforcer- **STANDARD**
- 10-092** -Round Corner Full Lip Strike
- 10-147** -Square Corner Integrated Strike and Reinforcer

STANDARD FEATURES / CONFIGURATIONS
B Series Deadbolts/Decorative Trim¹
Grade 1 / AAA deadbolt standard features / configurations

B80 and B81 are not graded

Models	B60, B62, B80, B81
Certification	ANSI/BHMA A156.36-2016 Commercial Grade 1 ANSI/BHMA A156.40-2015 Residential Grade AAA Available UL Listed for 3-hour fire door (B60, B80 and B81 only)
Deadbolt	1" x 2-1/4", radius corner, 1" housing diameter, 1" throw, latch number 12-321
Strike	1-1/8" x 2-3/4", 1/4" radius corner, strike number 10-116
Backset	Adjustable for 2-3/8" or 2-3/4"
Cylinder	Optional N6: 6-pin, keyed 6-pin, C keyway, keyed alike (KA4) Optional N: 5-pin, keyed 5-pin, C keyway, keyed alike (KA4) Standard N6-5: 6-pin, keyed 5-pin, C keyway, keyed alike (KA4) Also available in Keyed Different (KD), Residential Construction Key (RCK) ² , Residential Master Key (RMK) ² , and commercial Master Key (MK)
Door Range	Standard 1-3/8" – 1-7/8", Optional door thickness available up to 2-1/4" for B60.
Keys	Two 48-180 keys per lock, 5-pin, keyed 5-pin, C section
Reinforcement	Integrated strike and reinforcer with 3" screws

¹ Locks are furnished with standard features unless otherwise specified. To order locks with non-standard features, specify non-standard feature desired.

² See pricing for RCK and RMK in Hardware & Accessories section.

FINISH CODES & DESCRIPTIONS

505	605	608	609	618	619	620	621	622	625	626	716
Lifetime Bright Brass	Bright Brass (US3)	Satin Brass	Antique Brass (US5)	Polished Nickel	Satin Nickel (US15)	Antique Pewter (US15A)	Distressed Nickel	Matte Black (US19)	Bright Chrome (US26)	Satin Chrome (US26D)	Aged Bronze

Non-standard finishes are not available.

PACKAGING & CARTON SPECS

	INDIVIDUAL CARTON				SHIPPER						
	CARTON WEIGHT	HEIGHT	WIDTH	DEPTH	QTY. SHIPPER	CARTON WEIGHT	CU. FT.	HEIGHT	WIDTH	DEPTH	
Deadbolts											
B60	1.60	2.86 in.	4.38 in.	5.66 in.	20	33.50	1.047	6.5 in.	15.3 in.	18.3 in.	
B62	1.60	2.86 in.	4.38 in.	5.66 in.	20	33.50	1.047	6.5 in.	15.3 in.	18.3 in.	
B80	1.08	2.86 in.	4.38 in.	5.66 in.	12	17.00	0.630	6.5 in.	15.3 in.	18.3 in.	
B81	1.08	2.86 in.	4.38 in.	5.66 in.	12	17.00	0.630	6.5 in.	15.3 in.	18.3 in.	
Decorative Collections Deadbolts											
	2.10	3.06 in.	4.37 in.	8.14 in.	20	42.10	1.520	9.0 in.	15.6 in.	18.8 in.	

For Retail Pack carton specs, see page 106.



B60



B62

**B Series
Deadbolts**

FINISHES

Function		Packaging	605	505	530	608	609	618	619	620	621	622	625	626	716
B60	Single Cylinder	Box/G	\$72	\$81	\$81	\$81	\$81	\$81	\$81	\$81	\$81	\$81	\$81	\$81	\$81
B62	Double Cylinder	Box/G	\$105	\$113	•	\$113	\$113	\$113	\$113	\$113	\$113	\$113	\$113	\$113	\$113
B80	One-sided	Box	\$48	•	•	\$57	\$57	\$57	\$57	\$57	\$57	\$57	\$57	\$57	\$57
B81	One-sided w trim	Box	\$51	\$61	•	\$61	\$61	\$61	\$61	\$61	\$61	\$61	\$61	\$61	\$61
B60R6	Single Cylinder Interchgbl. Core-6-pin	Box	•	\$209	•	•	•	•	\$207	•	•	•	•	\$207	\$209

List Price Adders:

- Retail Package Options (highlighted) - add \$7.00 to list price.
- Note: B60 and B62 in 626 Finish is available as CSV - add \$13.00 to list price.
- CSV - Contractor Series VisPack (Includes Light Commercial packaging and comes standard with UL fire rated latches.)
- Decorative Trim Option - See chart on page 65 (available only with B60).
- Triple Option Latch - add \$3.00 to list price; Box Pack Only.
- UL Latch - add \$7.00 to list price (B60, B80, B81 Functions Box Pack Only).
- B62 NOT AVAILABLE WITH UL LATCH.**
- Split Finish - add \$8.00 to highest list price; Box Pack Only.

Stand out *effortlessly.*
 Schlage's Decorative Collections offer thousands of additional design and finish combinations.
See page 65 for details.

SCHLAGE'S DECORATIVE COLLECTIONS

Stand out *effortlessly*.

Schlage's Decorative Collections make it easy to match our strength to your style. With more than 1,000 customized design and finish options in all, your decor will be limited by only your imagination.



Pair a deadbolt with our inspired decorative trim options to bring your vision to life.*

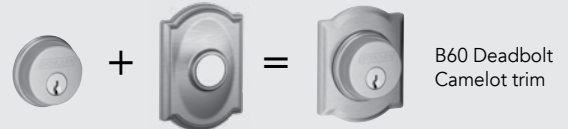

* Locks ship complete with trim attached

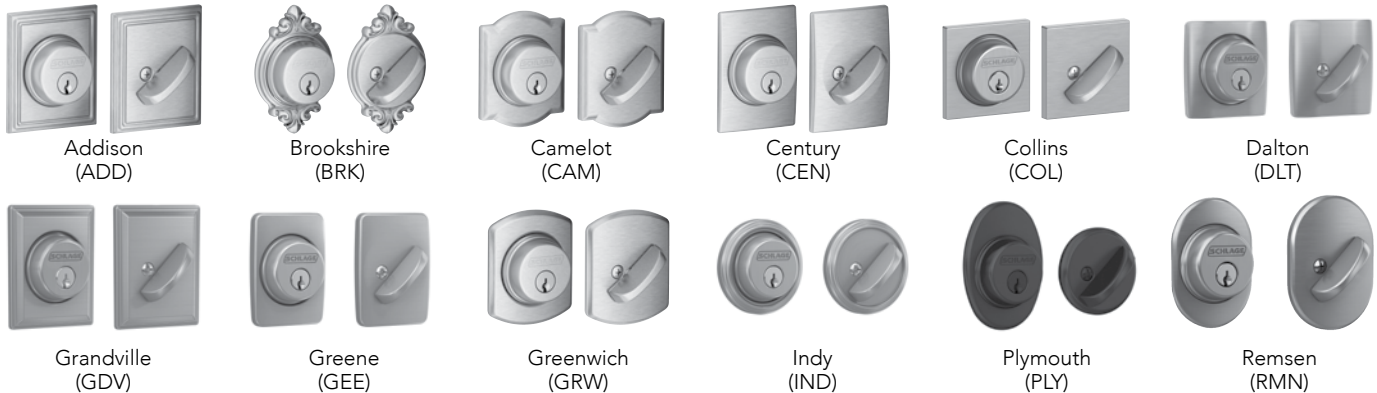

Follow these steps for pricing decorative combinations:

1. Locate the list price of the deadbolt in the Deadbolt section.
2. Use the chart below to find the list price adder for the matching Decorative Collection upgrade.
3. Add the list prices together for the total list price of the new combination.
4. Photos shown are representative of the design only.

Decorative trim finish

FINISHES AVAILABLE

	605	505	530	608	609	618	619	620	621	622	625	626	716
Addison (ADD)	•	•	•	•	\$19	•	\$19	•	\$19	\$19	\$19	•	\$19
Brookshire (BRK)	•	•	•	•	\$19	•	\$19	•	•	•	•	•	\$19
Camelot (CAM)	\$19	\$19	\$19	\$19	\$19	•	\$19	\$19	•	\$19	\$19	•	\$19
Century (CEN)	•	•	\$19	\$19	•	\$19	\$19	•	•	\$19	\$19	\$19	\$19
Collins (COL)	•	•	\$19	\$19	•	\$19	\$19	•	•	\$19	\$19	\$19	\$19
Dalton (DLT)	•	•	•	•	•	•	\$19	•	•	\$19	•	•	•
Grandville (GDV)	•	•	•	•	•	•	\$19	•	•	•	•	•	\$19
Greene (GEE)	•	•	•	•	•	•	\$19	•	•	\$19	•	•	•
Greenwich (GRW)	•	•	•	•	•	\$19	\$19	•	•	\$19	\$19	\$19	\$19
Indy (IND)	•	•	•	•	•	•	\$19	•	•	\$19	\$19	•	\$19
Plymouth (PLY)	•	•	•	•	•	•	•	•	•	\$19	•	•	•
Remsen (RMN)	•	•	•	\$19	•	•	\$19	•	•	\$19	\$19	•	\$19



EXAMPLE 1: To Price a B60 CAM 619 12-321 10-116, take the list price of a B60 619 12-321 10-116 at \$81.00 and add the Camelot Decorative Trim Adder of \$19.00 for a total list price of \$100.00.

\$81.00	(B60 619 12-321 10-116)
+ \$19.00	(Camelot Decorative Trim 619)
\$100.00	Total cost
	(B60 CAM 619 12-321 10-116)

When ordering a decorative collection product, specify the trim after the function code.
 Example: B60 **CAM** 619 or B60 **ADD** 716

Only available in B60 function.
 Split finish - add \$8.00 to highest list price; Box pack only.



Notes

**To order
latches and strikes
see page 96-97**

**J Series Deadbolts
AVAILABLE FUNCTIONS**



JD60



JD80



JD81

ANSI/BHMA A156.36-2010 Commercial Grade 3

JD60 - Single Cylinder Deadbolt Lock

- Deadbolt thrown or retracted by key from outside or by inside turn unit
- Bolt automatically deadlocks when fully thrown

JD80 - One Sided Deadbolt

- Deadbolt thrown or retracted from interior side only

JD81 - One-sided Deadbolt Lock with

- Exterior Plate
- Deadbolt thrown or retracted from interior side only

***Caution:** Double cylinder locks on residences and any door in any structure which is used for egress are a life safety hazard in times of emergency and their use is not recommended. Installation should be in accordance with existing codes only.

PRODUCT IDENTIFICATION

JD	60	F	605	16-068	10-103	KA4
Lock Series	Product	Suffix/Package	Finish Code	Latch	Strike	Keying

LATCHES & STRIKES

Latches

16-068 - Triple Option (Round, Drive-in) - **STANDARD**

16-063 - UL Listed 3 Hour, Square Corner

Strikes

10-267 - One Radius Deadbolt Full Lip Strike (10-102) & One Radius Deadbolt Strike (10-103) - **STANDARD**

10-099 - Square Strike Plate & Strike Frame Reinforcer

STANDARD FEATURES / CONFIGURATIONS

J Series Deadbolts	
	Description
Certification:	ANSI/BHMA A156.36-2010 Commercial Grade 3 Available option for UL Listed for 3 hour fire door (JD60, JD80 and JD81 functions only)
Deadbolt Latch:	Dual Option: 1" x 2-1/4", 1/4" round faceplate, drive-in latch, 1" housing diameter, 1" throw
Strike:	1" x 2-1/4" round corner and radius corner, full lip
Backset:	Adjustable for 2-3/8" or 2-3/4"
Cylinder:	5-pin, C keyway, Keyed Alike (KA4) Also available in Keyed Different (KD), Residential Construction Key (RCK) ¹ , Residential Master Key (RMK) ¹ , and commercial Master Key (MK)
Door Range:	1-3/8" – 1-3/4"
Keys:	Two 48-155 brass cut keys per lock, 5-pin, C section

¹ See pricing for RCK and RMK in Hardware & Accessories section.

FINISH CODES & DESCRIPTIONS

605	609	619	620	622	625	626	630	716
Bright Brass (US3)	Antique Brass (US5)	Satin Nickel (US15)	Antique Pewter (US15A)	Matte Black (US19)	Bright Chrome (US26)	Satin Chrome (US26D)	Satin Stainless Steel (US32D)	Aged Bronze

Non-standard finishes are not available.

PACKAGING & CARTON SPECS

	INDIVIDUAL CARTON				SHIPPER						
	CARTON WEIGHT	HEIGHT	WIDTH	DEPTH	QTY. SHIPPER	CARTON WEIGHT	CU. FT.	HEIGHT	WIDTH	DEPTH	
Levers											
JD60	1.49	3.15 in.	3.74 in.	3.74 in.	24	35.86	0.886	8.9 in.	12.4 in.	13.8 in.	
JD80	1.05	2.80 in.	3.11 in.	3.31 in.	24	25.30	0.595	8.0 in.	10.4 in.	12.3 in.	
JD81	1.05	2.80 in.	3.11 in.	3.31 in.	24	25.30	0.595	8.0 in.	10.4 in.	12.3 in.	
JD60F	1.49	3.15 in.	3.74 in.	3.74 in.	24	35.86	0.886	8.9 in.	12.4 in.	13.8 in.	

For Vis Pack carton specs, see page 106.



JD60



JD80

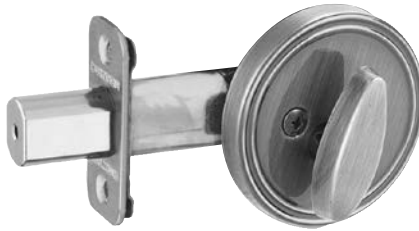

JD81

**J Series
Deadbolts**

FINISHES

Function		Packaging	605	609	619	620	622	625	626	630	716
JD60	Single Cylinder Deadbolt	Box	\$45	\$45	\$45	\$45	\$45	\$45	\$45	\$45	\$45
JD80	One-Sided Cylinder Deadbolt	Box	\$40	\$40	\$40	•	•	•	•	\$40	\$40
JD81	One-Sided Deadbolt with trim	Box	\$40	\$40	\$40	•	•	•	•	\$40	•
JD60F	Single Cylinder UL Version	Box	\$52	\$52	\$52	\$52	\$52	\$52	\$52	\$52	\$52
JW60	Single Cylinder Deadbolt	Vis	\$50	•	\$50	•	\$50	•	•	\$50	\$50

NOTE: Standard latch is Dual Option (Round, Drive-in).

List Price Adders:

UL Latch - add \$6.00 to list price (JD60, JD80 Functions Box Pack Only).

JD62 NOT AVAILABLE WITH UL LATCH.



Notes

Builder's Hardware 71
 Barn Door Hardware 72
 Hinges 73
 Door Stops 74
 Pocket Door Hardware 75
 Mail Slots, Viewers & Door Knockers 76
 Classic House Numbers 77
 Push, Pull & Kick Plates 79
 Hooks 80
 Handrail Brackets 81
 Window Hardware, Flush Pulls 82
 Parts 83
 Latch & Strike Quick Reference Guide 83
 F Series Latches 84
 F Series Strikes 87
 Cylinders 89
 Thick Door Installation Kits 91
 Miscellaneous Parts 91
 Discontinued Lock Parts 91
 Key & Cylinder Stamping 93
 Residential Master & Construction Keying 93
 Construction Core Program 95
 J Series Latches 96
 J Series Strikes 97

FINISH CODES & DESCRIPTIONS

28	32D	605/3	609/5	619	620	716
Satin Aluminum	Satin Stainless Steel	Bright Brass (US3)	Antique Brass (US5)	Satin Nickel (US15)	Antique Pewter (US15A)	Aged Bronze

Barndoor Hardware



J Strap



Top Mount

J STRAP

Description	Finish	Track Length	SKU	Price
SD10-6.6 619 JSTP N N SL, Satin Nickel J Strap	619	6FT 6IN	043156002634	\$344.00
SD10-6.6 622 JSTP N N SL, Black J Strap	622	6FT 6IN	043156002641	\$217.00
SD10-6.6 630 JSTP N N SL, Stainless Steel J Strap	630	6FT 6IN	043156002658	\$434.00
SD10-6.6 716 JSTP N N SL, Aged Bronze J Strap	716	6FT 6IN	043156002672	\$336.00
SD10-8.0 619 JSTP N N SL, Satin Nickel J Strap	619	8FT	043156002832	\$354.00
SD10-8.0 622 JSTP N N SL, Black J Strap	622	8FT	043156002849	\$222.00
SD10-8.0 630 JSTP N N SL, Stainless Steel J Strap	630	8FT	043156002856	\$444.00
SD10-8.0 716 JSTP N N SL, Aged Bronze J Strap	716	8FT	043156002870	\$333.00

TOP MOUNT

Description	Finish	Track Length	SKU	Price
SD10-6.6 619 TMNT N N SL, Satin Nickel Top Mount	619	6FT 6IN	043156002788	\$344.00
SD10-6.6 622 TMNT N N SL, Black Top Mount	622	6FT 6IN	043156002795	\$217.00
SD10-6.6 630 TMNT N N SL, Stainless Steel Top Mount	630	6FT 6IN	043156002801	\$434.00
SD10-6.6 716 TMNT N N SL, Aged Bronze Top Mount	716	6FT 6IN	043156002825	\$336.00
SD10-8.0 619 TMNT N N SL, Satin Nickel Top Mount	619	8FT	043156002986	\$354.00
SD10-8.0 622 TMNT N N SL, Black Top Mount	622	8FT	043156002993	\$222.00
SD10-8.0 630 TMNT N N SL, Stainless Steel Top Mount	630	8FT	043156003006	\$444.00
SD10-8.0 716 TMNT N N SL, Aged Bronze Top Mount	716	8FT	043156003020	\$333.00

TRACK ADAPTER

Description	Finish	SKU	Price
SD10 619 ADPTR N N SL, Satin Nickel Track Adapter	619	043156003051	\$17.90
SD10 622 ADPTR N N SL, Black Track Adapter	622	043156003068	\$15.50
SD10 630 ADPTR N N SL, Stainless Steel Track Adapter	630	043156003075	\$18.90
SD10 716 ADPTR N N SL, Aged Bronze Track Adapter	716	043156003099	\$17.90

Door Hinges

- 5 hinge styles with 6 finishes for each.
- These hinges are all steel and feature a removable pin.
- These hinges come in box pack with 3 hinges per pack.
- Customers who previously purchased 605 Bright Brass and 609 Antique Brass should now purchase 608 Satin Brass.
- Customers who previously purchased 620 Antique Pewter should now purchase 530 Black Stainless.



1010
3.5" Hinge,
Square Corner



1011
3.5" Hinge,
5/8" Radius Corner



1012
3.5" Hinge,
1/4" Radius Corner



1020
4" Hinge,
Square Corner



1021
4" Hinge,
5/8" Radius Corner

HINGES

UPC	Part No./Description	Model	Pkg. Type	Master Case Qty	Price per 3 Pack
194555079465	S3P1010F-RP-530 (3.5" Hinge SQ, Black Stainless, 3 PK)	1010F	3 Pack	20	\$28.60
194555079472	S3P1010F-RP-608 (3.5" Hinge SQ, Satin Brass, 3 PK)	1010F	3 Pack	20	\$28.60
194555079489	S3P1010F-RP-619 (3.5" Hinge SQ, Satin Nickel, 3 PK)	1010F	3 Pack	20	\$28.60
194555079496	S3P1010F-RP-622 (3.5" Hinge SQ, Matte Black, 3 PK)	1010F	3 Pack	20	\$28.60
194555079502	S3P1010F-RP-625 (3.5" Hinge SQ, Bright Chrome, 3 PK)	1010F	3 Pack	20	\$28.60
194555079519	S3P1010F-RP-716 (3.5" Hinge SQ, Aged Bronze, 3 PK)	1010F	3 Pack	20	\$28.60
194555079526	S3P1011F-RP-530 (3.5" Hinge 5/8" RAD, Black Stainless, 3 PK)	1011F	3 Pack	20	\$28.60
194555079533	S3P1011F-RP-608 (3.5" Hinge 5/8" RAD, Satin Brass, 3 PK)	1011F	3 Pack	20	\$28.60
194555079540	S3P1011F-RP-619 (3.5" Hinge 5/8" RAD, Satin Nickel, 3 PK)	1011F	3 Pack	20	\$28.60
194555079557	S3P1011F-RP-622 (3.5" Hinge 5/8" RAD, Matte Black, 3 PK)	1011F	3 Pack	20	\$28.60
194555079564	S3P1011F-RP-625 (3.5" Hinge 5/8" RAD, Bright Chrome, 3 PK)	1011F	3 Pack	20	\$28.60
194555079571	S3P1011F-RP-716 (3.5" Hinge 5/8" RAD, Aged Bronze, 3 PK)	1011F	3 Pack	20	\$28.60
194555079588	S3P1012F-RP-530 (3.5" Hinge 1/4" RAD, Black Stainless, 3 PK)	1012F	3 Pack	20	\$28.60
194555079595	S3P1012F-RP-608 (3.5" Hinge 1/4" RAD, Satin Brass, 3 PK)	1012F	3 Pack	20	\$28.60
194555079601	S3P1012F-RP-619 (3.5" Hinge 1/4" RAD, Satin Nickel, 3 PK)	1012F	3 Pack	20	\$28.60
194555079618	S3P1012F-RP-622 (3.5" Hinge 1/4" RAD, Matte Black, 3 PK)	1012F	3 Pack	20	\$28.60
194555079625	S3P1012F-RP-625 (3.5" Hinge 1/4" RAD, Bright Chrome, 3 PK)	1012F	3 Pack	20	\$28.60
194555079632	S3P1012F-RP-716 (3.5" Hinge 1/4" RAD, Aged Bronze, 3 PK)	1012F	3 Pack	20	\$28.60
194555079649	S3P1020F-RP-530 (4" Hinge SQ, Black Stainless, 3 PK)	1020F	3 Pack	18	\$30.60
194555079656	S3P1020F-RP-608 (4" Hinge SQ, Satin Brass, 3 PK)	1020F	3 Pack	18	\$30.60
194555079687	S3P1020F-RP-619 (4" Hinge SQ, Satin Nickel, 3 PK)	1020F	3 Pack	18	\$30.60
194555079694	S3P1020F-RP-622 (4" Hinge SQ, Matte Black, 3 PK)	1020F	3 Pack	18	\$30.60
194555079700	S3P1020F-RP-625 (4" Hinge SQ, Bright Chrome, 3 PK)	1020F	3 Pack	18	\$30.60
194555079717	S3P1020F-RP-716 (4" Hinge SQ, Aged Bronze, 3 PK)	1020F	3 Pack	18	\$30.60
194555079724	S3P1021F-RP-530 (4" Hinge 5/8" RAD, Black Stainless, 3 PK)	1021F	3 Pack	18	\$30.60
194555079731	S3P1021F-RP-608 (4" Hinge 5/8" RAD, Satin Brass, 3 PK)	1021F	3 Pack	18	\$30.60
194555079748	S3P1021F-RP-619 (4" Hinge 5/8" RAD, Satin Nickel, 3 PK)	1021F	3 Pack	18	\$30.60
194555079755	S3P1021F-RP-622 (4" Hinge 5/8" RAD, Matte Black, 3 PK)	1021F	3 Pack	18	\$30.60
194555079762	S3P1021F-RP-625 (4" Hinge 5/8" RAD, Bright Chrome, 3 PK)	1021F	3 Pack	18	\$30.60
194555079779	S3P1021F-RP-716 (4" Hinge 5/8" RAD, Aged Bronze, 3 PK)	1021F	3 Pack	18	\$30.60

Door Stops



Hinge Pin Door Stop
Model 70



Convex Wall Stop
Model 407



Floor Door Stop
Model 436

DOOR STOPS

UPC	Part No./Description	Finish	Substrate	Case Qty.	Pkg. Type	Price
044074681413	SPS70B 605 N N (Hinge Pin Door Stop, Bright Brass)	605	Brass	15	Slim Pack	\$13.60
044074681444	SPS70B 619 N N (Hinge Pin Door Stop, Satin Nickel)	619	Brass	15	Slim Pack	\$16.90
044074681451	SPS70B 620 N N (Hinge Pin Door Stop, Antique Pewter)	620	Brass	15	Slim Pack	\$16.90
044074681437	SPS70B 716 N N (Hinge Pin Door Stop, Aged Bronze)	716	Brass	15	Slim Pack	\$16.90
044074680836	SC70B 605 N N (Hinge Pin Door Stop, Bright Brass)	605	Brass	5	Carded	\$13.60
044074680867	SC70B 619 N N (Hinge Pin Door Stop, Satin Nickel)	619	Brass	5	Carded	\$16.90
44074680874	SC70B 620 N N (Hinge Pin Door Stop, Antique Pewter)	620	Brass	5	Carded	\$16.90
044074680850	SC70B 716 N N (Hinge Pin Door Stop, Aged Bronze)	716	Brass	5	Carded	\$16.90
044074681468	SPS407B* 605 N N (Wall Door Stop - Convex, Bright Brass)	605	Brass	15	Slim Pack	\$4.80
044074681970	SPS436B 605 N N (Floor Door Stop, Bright Brass)	605	Brass	15	Slim Pack	\$7.80
044074682007	SPS436B 619 N N (Floor Door Stop, Satin Nickel)	619	Brass	15	Slim Pack	\$8.30
044074681994	SPS436B 716 N N (Floor Door Stop, Aged Bronze)	716	Brass	15	Slim Pack	\$8.30

* While supplies last.



Solid Door Stop
Model 61

SOLID DOOR STOPS

UPC	Part No./Description	Finish	Substrate	Case Qty.	Pkg. Type	Price
044074681369	SPS61MB 605 N N (Solid Door Stop, Bright Brass)	605	Brass	20	Slim Pack	\$14.30
044074681376	SPS61MB 609 N N (Solid Door Stop, Antique Brass)	609	Brass	20	Slim Pack	\$14.30
044074681390	SPS61MB 619 N N (Solid Door Stop, Satin Nickel)	619	Brass	20	Slim Pack	\$19.30
044074681406	SPS61MB 620 N N (Solid Door Stop, Antique Pewter)	620	Brass	20	Slim Pack	\$19.30
044074681383	SPS61MB 716 N N (Solid Door Stop, Aged Bronze)	716	Brass	20	Slim Pack	\$19.30
044074680782	SC61MB 605 N N (Solid Door Stop, Bright Brass)	605	Brass	20	Carded	\$14.30
044074680799	SC61MB 609 N N (Solid Door Stop, Antique Brass)	609	Brass	20	Carded	\$14.30
044074680812	SC61MB 619 N N (Solid Door Stop, Satin Nickel)	619	Brass	20	Carded	\$19.30
044074680805	SC61MB 716 N N (Solid Door Stop, Aged Bronze)	716	Brass	20	Carded	\$19.30

Pocket Door Hardware



Pocket Door Lock
Passage - Model 990



Pocket Door Lock
Privacy - Model 991

POCKET DOOR LOCKS

UPC	Part No./Description	Finish	Substrate	Case Qty.	Pkg. Type	Price
044074681260	SC990B 605 N N (Sliding Door Pull, Bright Brass)	605	Brass	5	Carded	\$11.50
044074681277	SC990B 609 N N (Sliding Door Pull, Antique Brass)	609	Brass	5	Carded	\$13.80
044074681291	SC990B 619 N N (Sliding Door Pull, Satin Nickel)	619	Brass	5	Carded	\$13.80
044074681307	SC990B 620 N N (Sliding Door Pull, Antique Pewter)	620	Brass	5	Carded	\$13.80
044074681284	SC990B 716 N N (Sliding Door Pull, Aged Bronze)	716	Brass	5	Carded	\$13.80
044074681314	SC991B 605 N N (Sliding Door Lock, Bright Brass)	605	Brass	5	Carded	\$19.10
044074681321	SC991B 609 N N (Sliding Door Lock, Antique Brass)	609	Brass	5	Carded	\$21.10
044074681345	SC991B 619 N N (Sliding Door Lock, Satin Nickel)	619	Brass	5	Carded	\$21.10
044074681352	SC991B 620 N N (Sliding Door Lock, Antique Pewter)	620	Brass	5	Carded	\$21.10
044074681338	SC991B 716 N N (Sliding Door Lock, Aged Bronze)	716	Brass	5	Carded	\$21.10

Mail Slots, Viewers & Door Knockers

Mail Slot - Model 620

MAIL SLOTS

UPC	Part No./Description	Finish	Substrate	Case Qty.	Pkg. Type	Price
044074008333	C620PA 28 2 X 11 N N (Mail Slot, Satin Aluminum)	628	Aluminum	2	Carded	\$54.80
044074678642	SC620B 3 2 x 11 N N (Mail Slot, Bright Brass)	605	Brass	2	Carded	\$90.20
044074678659	SC620B 619 2 x 11N N (Mail Slot, Satin Nickel)	619	Brass	2	Carded	\$111.00
044074681239	SC620B 716 2 x 11N N (Mail Slot, Aged Bronze)	716	Brass	2	Carded	\$111.00

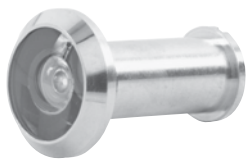

190° Viewer



120° Viewer

Viewers

UPC	Part No./Description	Model	Substrate	Case Qty.	Pkg. Type	Price
044074678536	SPS698P 619 (190 Degree Viewer, Satin Nickel)	698	Brass	10	Slim Pack	\$24.80
044074678550	SC700P* B 605 N N (120 Degree Viewer, Bright Brass) (1-3/8 – 2-1/16")	700	Brass	5	Carded	\$9.30

* While supplies last.



3107 Door Knocker



3125 Door Knocker

DOOR KNOCKERS

UPC	Part No./Description	Finish	Substrate	Case Qty.	Pkg. Type	Price
044074678475	SC2 3107 605 N N (Door Knocker, Bright Brass)	605	Brass	2	Carded	\$57.40
044074680461	SC2 3107 619 N N (Door Knocker, Satin Nickel)	619	Brass	2	Carded	\$70.80
044074678499	SC2 3125 605 N N (Door Knocker, Bright Brass)	605	Brass	5	Carded	\$31.80
044074680768	SC2 3125 609 N N (Door Knocker, Antique Brass)	609	Brass	5	Carded	\$38.10
044074678505	SC2 3125 619 N N (Door Knocker, Satin Nickel)	619	Brass	5	Carded	\$38.10
044074680478	SC2 3125 716 N N (Door Knocker, Aged Bronze)	716	Brass	5	Carded	\$38.10

Classic House Numbers



4" Classic House Numbers

4" CLASSIC HOUSE NUMBERS

UPC	Part No./Description	Model	Substrate	Case Qty.	Pkg. Type	Price
044074678666	SC2 3006 605 N N (4" Classic House Number 0, Bright Brass)	3006	Brass	5	Carded	\$9.70
044074678772	SC2 3006 619 N N (4" Classic House Number 0, Satin Nickel)	3006	Brass	5	Carded	\$12.50
044074680485	SC2-3006 716 N N (4" Classic House Number 0, Aged Bronze)	3006	Brass	5	Carded	\$12.50
044074678673	SC2 3016 605 N N (4" Classic House Number 1, Bright Brass)	3016	Brass	5	Carded	\$9.70
044074678789	SC2 3016 619 N N (4" Classic House Number 1, Satin Nickel)	3016	Brass	5	Carded	\$12.50
044074680492	SC2 3016 716 N N (4" Classic House Number 1, Aged Bronze)	3016	Brass	5	Carded	\$12.50
044074678697	SC2 3026 605 N N (4" Classic House Number 2, Bright Brass)	3026	Brass	5	Carded	\$9.70
044074678796	SC2 3026 619 N N (4" Classic House Number 2, Satin Nickel)	3026	Brass	5	Carded	\$12.50
044074680508	SC2 3026 716 N N (4" Classic House Number 2, Aged Bronze)	3026	Brass	5	Carded	\$12.50
044074678703	SC2 3036 605 N N (4" Classic House Number 3, Bright Brass)	3036	Brass	5	Carded	\$9.70
044074678802	SC2 3036 619 N N (4" Classic House Number 3, Satin Nickel)	3036	Brass	5	Carded	\$12.50
044074680515	SC2 3036 716 N N (4" Classic House Number 3, Aged Bronze)	3036	Brass	5	Carded	\$12.20
044074678710	SC2 3046 605 N N (4" Classic House Number 4, Bright Brass)	3046	Brass	5	Carded	\$9.70
044074678819	SC2 3046 619 N N (4" Classic House Number 4, Satin Nickel)	3046	Brass	5	Carded	\$12.50
044074680522	SC2 3046 716 N N (4" Classic House Number 4, Aged Bronze)	3046	Brass	5	Carded	\$12.50

Classic House Numbers



4" Classic House Numbers

4" CLASSIC HOUSE NUMBERS

UPC	Part No./Description	Model	Substrate	Case Qty.	Pkg. Type	Price
044074678727	SC2 3056 605 N N (4" Classic House Number 5, Bright Brass)	3056	Brass	5	Carded	\$9.70
044074678826	SC2 3056 619 N N (4" Classic House Number 5, Satin Nickel)	3056	Brass	5	Carded	\$12.50
044074680539	SC2 3056 716 N N (4" Classic House Number 5, Aged Bronze)	3056	Brass	5	Carded	\$12.50
044074678734	SC2 3066 605 N N (4" Classic House Number 6, Bright Brass)	3066	Brass	5	Carded	\$9.70
044074678833	SC2 3066 619 N N (4" Classic House Number 6, Satin Nickel)	3066	Brass	5	Carded	\$12.50
044074680546	SC2 3066 716 N N (4" Classic House Number 6, Aged Bronze)	3066	Brass	5	Carded	\$12.50
044074678741	SC2 3076 605 N N (4" Classic House Number 7, Bright Brass)	3076	Brass	5	Carded	\$9.70
044074678840	SC2 3076 619 N N (4" Classic House Number 7, Satin Nickel)	3076	Brass	5	Carded	\$12.50
044074680553	SC2 3076 716 N N (4" Classic House Number 7, Aged Bronze)	3076	Brass	5	Carded	\$12.50
044074678758	SC2 3086 605 N N (4" Classic House Number 8, Bright Brass)	3086	Brass	5	Carded	\$9.70
044074678857	SC2 3086 619 N N (4" Classic House Number 8, Satin Nickel)	3086	Brass	5	Carded	\$12.50
044074680560	SC2 3086 716 N N (4" Classic House Number 8, Aged Bronze)	3086	Brass	5	Carded	\$12.50
044074678765	SC2 3096 605 N N (4" Classic House Number 9, Bright Brass)	3096	Brass	5	Carded	\$9.70
044074678864	SC2 3096 619 N N (4" Classic House Number 9, Satin Nickel)	3096	Brass	5	Carded	\$12.50
044074680577	SC2 3096 716 N N (4" Classic House Number 9, Aged Bronze)	3096	Brass	5	Carded	\$12.50

Push, Pull & Kick Plates

 Door Pull
Model 8112

 Push Plate
Model 8200

 Pull Plate
Models 8302 & 8311

PUSH AND PULL PLATES

UPC	Part No./Description	Finish	Substrate	Case Qty.	Pkg. Type	Price
044074008371	C8112 5PA 28 N N (Door Pull, Satin Aluminum)	628	Aluminum	2	Carded	\$29.30
044074008395	C8200PA 28 3X12 N N (Push Plate, Satin Aluminum)	628	Aluminum	5	Carded	\$11.20
044074008418	C8200PA 28 3.5X15 N N (Push Plate, Satin Aluminum)	628	Aluminum	5	Carded	\$11.50
044074679014	SC8200B 3 3.5X15 N N (Push Plate, Bright Brass)	605	Brass	5	Carded	\$26.40
044074008425	CGC8200S32D 3.5X15 N N (Push Plate, Stainless Steel)	630	Stainless	5	Carded	\$19.10
044074008432	C8302 6PA 28 3.5X15G N N (Pull Plate, Satin Aluminum)	628	Aluminum	2	Carded	\$42.50
043156253258	SC8311 5PA3 3.5X15 N N (Pull Plate, Bright Brass)	605	Aluminum	5	Carded	\$49.50
044074008456	C8311 5PA 28 3.5X15G N N (Pull Plate, Satin Aluminum)	628	Aluminum	5	Carded	\$46.20
044074589498	CGC8311-5B26D 3.5X15 (Pull Plate, SATIN CHROME)	626	Brass	5	Carded	\$89.10
044074681253	SC8311 5B 3 3.5X15G N N (Pull Plate, Bright Brass)	605	Brass	5	Carded	\$80.70

 Kick Plate
Model 8400

KICKPLATES

UPC	Part No./Description	Finish	Substrate	Case Qty.	Pkg. Type	Price
044074006940	C8400B 3 6X30 N N (Kickplate, Bright Brass)	605	Brass	5	Carded	\$63.00
044074681185	SC8400B 619 6X30 N N (Kickplate, Satin Nickel)	619	Brass	5	Carded	\$66.80
044074681178	SC8400B 716 6X30 N N (Kickplate, Aged Bronze)	716	Brass	5	Carded	\$66.80
044074678567	SC8400PA 3 6X30 N N (Kickplate, Bright Brass)	605	Aluminum	5	Carded	\$40.80
044074008623	C8400PA 28 6X30 N N (Kickplate, Satin Aluminum)	628	Aluminum	5	Carded	\$27.90
044074051087	C8400B 3 6X34 N N (Kickplate, Bright Brass)	605	Brass	5	Carded	\$66.80
044074678574	SC8400PA 3 6X34 N N (Kickplate, Bright Brass)	605	Aluminum	5	Carded	\$42.70
044074051063	C8400PA 28 6X34 N N (Kickplate, Satin Aluminum)	628	Aluminum	5	Carded	\$29.80
044074589337	CGC8400S 32D 8X34 N N (Kickplate, Stainless Steel)	630	Stainless	5	Carded	\$41.80
044074678581	SC8400B 3 8X34 N N (Kickplate, Bright Brass)	605	Brass	5	Carded	\$74.30
044074678628	SC8400PA 3 8X34 N N (Kickplate, Bright Brass)	605	Aluminum	5	Carded	\$51.80
044074678598	SC8400PA 619 8X34 N N (Kickplate, Satin Nickel)	619	Aluminum	5	Carded	\$52.20
044074678611	SC8400PA 28 8X34 N N (Kickplate, Satin Aluminum)	628	Aluminum	5	Carded	\$37.10
044074682038	SC8400PA 716 8X34 N N (Kickplate, Aged Bronze)	716	Aluminum	5	Carded	\$51.00

Hooks



Coat & Hat Hook
Model 571



Wardrobe Hook - Single
Model 581



Wardrobe Hook - Double
Model 582

COAT, HAT & WARDROBE HOOKS

UPC	Part No./Description	Finish	Substrate	Case Qty.	Pkg. Type	Price
044074681611	SPS571MB 605 N N (Coat & Hat Ceiling Hooks, Bright Brass)	605	Brass	25	Slim Pack	\$10.00
044074681628	SPS571MB 609 N N (Coat & Hat Ceiling Hooks, Antique Brass)	609	Brass	25	Slim Pack	\$12.60
044074681642	SPS571MB 619 N N (Coat & Hat Ceiling Hooks, Satin Nickel)	619	Brass	25	Slim Pack	\$12.60
044074681659	SPS571MB 620 N N (Coat & Hat Ceiling Hooks, Antique Pewter)	620	Brass	25	Slim Pack	\$12.60
044074681635	SPS571MB 716 N N (Coat & Hat Ceiling Hooks, Aged Bronze)	716	Brass	25	Slim Pack	\$12.60
044074681666	SPS581MB 605 N N (Wardrobe Hook, Bright Brass)	605	Brass	25	Slim Pack	\$6.90
044074681673	SPS581MB 609 N N (Wardrobe Hook, Antique Brass)	609	Brass	25	Slim Pack	\$8.60
044074681703	SPS581MB 619 N N (Wardrobe Hook, Satin Nickel)	619	Brass	25	Slim Pack	\$8.60
044074681710	SPS581MB 620 N N (Wardrobe Hook, Antique Pewter)	620	Brass	25	Slim Pack	\$8.60
044074681680	SPS581MB 716 N N (Wardrobe Hook, Aged Bronze)	716	Brass	25	Slim Pack	\$8.60
044074681727	SPS582MB 605 N N (Wardrobe Hook, Bright Brass)	605	Brass	25	Slim Pack	\$8.80
044074681734	SPS582MB 609 N N (Wardrobe Hook, Antique Brass)	609	Brass	25	Slim Pack	\$11.00
044074681741	SPS582MB 619 N N (Wardrobe Hook, Satin Nickel)	619	Brass	25	Slim Pack	\$11.00
044074681758	SPS582MB 620 N N (Wardrobe Hook, Antique Pewter)	620	Brass	25	Slim Pack	\$11.00
044074681963	SPS582MB 716 N N (Wardrobe Hook, Aged Bronze)	716	Brass	25	Slim Pack	\$11.00

Handrail Brackets



Handrail Bracket
Model 059

HANDRAIL BRACKETS

UPC	Part No./Description	Finish	Substrate	Case Qty.	Pkg. Type	Price
044074681567	SPS059B 605 N N (Handrail Brackets, Bright Brass)	605	Brass	10	Slim Pack	\$23.50
044074681598	SPS059B 619 N N (Handrail Brackets, Satin Nickel)	619	Brass	10	Slim Pack	\$26.90
044074681604	SPS059B 620 N N (Handrail Brackets, Antique Pewter)	620	Brass	10	Slim Pack	\$26.90
044074681581	SPS059B 716 N N (Handrail Brackets, Aged Bronze)	716	Brass	10	Slim Pack	\$26.90
044074680904	SC059B 716 N N (Handrail Brackets, Aged Bronze)	716	Brass	5	Carded	\$26.90

Window Hardware, Flush Pulls



Window Lock - Model 07



Bar Window Lift - Model 026

WINDOW HARDWARE

UPC	Part No./Description	Finish	Substrate	Case Qty.	Pkg. Type	Price
044074681765	SPS07MB 605 N N (Window Locks, Bright Brass)	605	Brass	20	Slim Pack	\$23.60
044074681772	SPS07MB 609 N N (Window Locks, Antique Brass)	609	Brass	20	Slim Pack	\$23.60
044074681796	SPS07MB 619 N N (Window Locks, Satin Nickel)	619	Brass	20	Slim Pack	\$23.60
044074681802	SPS07MB 620 N N (Window Locks, Antique Pewter)	620	Brass	20	Slim Pack	\$23.60
044074681789	SPS07MB 716 N N (Window Locks, Aged Bronze)	716	Brass	20	Slim Pack	\$23.60
044074681819	SPS026MB 605 N N (Window Lifts, Bright Brass)	605	Brass	20	Slim Pack	\$10.00
044074681826	SPS026MB 609 N N (Window Lifts, Antique Brass)	609	Brass	20	Slim Pack	\$11.90
044074681840	SPS026MB 619 N N (Window Lifts, Satin Nickel)	619	Brass	20	Slim Pack	\$11.90
044074681857	SPS026MB 620 N N (Window Lifts, Antique Pewter)	620	Brass	20	Slim Pack	\$11.90
044074681833	SPS026MB 716 N N (Window Lifts, Aged Bronze)	716	Brass	20	Slim Pack	\$11.90



Flush Pull - Model 221

FLUSH PULLS

UPC	Part No./Description	Finish	Substrate	Case Qty.	Pkg. Type	Price
044074681512	SPS221B* 605 N N (Door Pull, Bright Brass)	605	Brass	25	Slim Pack	\$4.20
044074681529	SPS221B* 609 N N (Door Pull, Antique Brass)	609	Brass	25	Slim Pack	\$5.40

* While supplies last.

Latch & Strike Quick Reference Guide
 Deadbolt & Latches

F Series Parts

LATCH REFERENCE GUIDE

Latches / Configuration	Deadbolt Latches				Spring Latches	
	B60/B62/ B80/B81	BE365 BE369NX BE375	F51/F80	FE575/FE595/ FE599NX/ FE695	F10/F40/ FE285	FC21/ FC285
Dual Option (Round, Drive-in) STANDARD	12-321	12-321	16-086	16-086	16-080	16-600
Square	12-288	12-288	16-207	16-207 (not FE599NX)	16-200	N/A
Triple Option	12-287	12-287	16-211	16-211	16-210	16-601
5"	12-349*	N/A	16-126	N/A	N/A	N/A

* Must be ordered separately.

UL LATCH GUIDE
UL Fire Rated Function

	B60F/ B80F/ B81F	BE365F	BE365F20	BE489/ BE499	F59/F60	F51AF/ F80F	F10F/ FE285F	FC21F
UL Fire Rating Time	3 hour	3 hour	20 min, no hose	20 min, no hose	3 hour	3 hour	3 hour	90 minute
UL Latch, Square Corner	12-294	12-294	12-318	12-351	12-353	16-203	16-203	16-620
UL Latch, Round Corner	12-397	12-397	12-319	N/A	12-354	16-204	16-204	16-621

STRIKE REFERENCE GUIDE

Configuration	Handlesets	Deadbolt	Keyed	Passage/Privacy	Tapered Deadbolt
	F59/F60/ F62	BE375/BE365/ BE369NX B60/B62/ B80/B81	FE595/FE575/ FE695/ FE599NX F51/F80	F10/F40/FE285/ FC21/FC285	BE469
Round Corner Full Lip	10-115	10-092	10-027	10-027	10-115
Round Corner		10-116			10-116
Square Corner Full Lip	N/A	N/A	10-026	10-026	N/A
Square Corner - T	N/A	N/A	10-001	10-001	N/A
Circular - Adjustable	N/A	N/A	10-058	10-058	N/A
Dual - Square & Round	10-269	N/A	10-063	10-063	N/A
ANSI Square	N/A	N/A	10-025	10-025	N/A
Dustbox (Black Plastic)	B520-283	B520-283	N/A	N/A	B520-283
Reinforcement Strike Plate	B502-914	B502-914	N/A	N/A	B502-914
3" Reinforcement Screws (2ea)	B502-873	B502-873	N/A	N/A	B502-873

F Series Parts
Latches
LATCHES (does not include Multi-Family product)

Category	Part Product	Specify Number	Finish	Description	Price Sold Separately	Add To Lock Price	
Electronics/ Connected & Light Commercial	BE489/BE499	12-351	x	Adjustable Latch Assy, Beveled, Triple Option, 20 Min Fire Rated (no hose)	N/A	NC	
	BE469NX/ BE468	12-342	x	Tapered Deadbolt Dual Option (Round, Drive-in) (Standard Configuration)	\$46.60	NC	
		12-344	x	Tapered Deadbolt Triple Option (Round, Square, Drive-in)	\$46.60	\$3.00	
	BE375/BE365/ BE369NX	12-321	x	1" x 2-1/4" Dual Option - Round Corner + Drive-in (Standard Configuration)	\$41.90	NC	
		12-287	x	1" x 2-1/4" Triple Option - Round Corner + Square Corner + Drive-in	\$57.40	\$3.00	
		12-288	x	1" x 2-1/4" Square Corner Faceplate	\$49.50	NC	
		12-294	x	1" x 2-1/4" Square Corner Faceplate + Firecup UL Listed for 3 hour fire door (BE365 only)	\$53.80	\$7.00	
		12-397	x	1" x 2-1/4" Round Corner Faceplate + Firecup UL Listed for 3 hour fire door (BE365 only)	*	\$7.00	
	FE595/FE575/ FE695	16-086	x	1" x 2-1/4" Dual Option - Round Corner + Drive-in (Standard Configuration)	\$21.60	NC	
		16-207	x	1" x 2-1/4" Square Corner Faceplate	\$19.60	NC	
		16-211	x	1" x 2-1/4" Triple Option - Round Corner + Square Corner + Drive-in	\$24.70	\$3.00	
	F Series Handlesets	FE285	16-080	x	1" x 2-1/4" Dual Option - Round Corner + Drive-in (Standard Configuration)	\$18.40	NC
			16-200	x	1" x 2-1/4" Square Corner Faceplate	\$16.90	NC
			16-210	x	1" x 2-1/4" Triple Option -Round Corner + Square Corner + Drive-in	\$20.80	\$3.00
			16-203	x	1" x 2-1/4" Square Corner Faceplate + Firecup + 1-1/8" Adaptor – UL (Standard Configuration-UL LISTED)	*	\$7.00
16-204			x	1" x 2-1/4" Radius Corner Faceplate + Firecup + 1-1/8" Adaptor – UL	*	\$7.00	

* Sold with complete UL lockset; not available for individual purchase.



F Series Parts
LATCHES CONT. (does not include Multi-Family product)

Category	Product	Part Number	Specify Finish	Description	Price Sold Separately	Add To Lock Price
F Series Handlesets	F59/F60/F62	12-322	x	1" x 2-1/4" Dual Option - Round Corner (16-080) + Drive-in (12-321) (Standard Configuration)	\$59.00	NC
		12-326	x	1" x 2-1/4" Triple Option - Round Corner + Square Corner (16-210) + Drive-in (12-287)	\$68.30	\$3.00
		12-353	x	1" x 2-1/4" Square Corner – UL Listed for 3 hour fire door (12-294 + 16-203) (F59/F60 only)	*	\$14.00
		12-354	x	1" x 2-1/4" Round Corner UL Listed for 3 hour fire door (12-397 + 16-204) (F59/F60 only)	*	\$14.00
F Series Knobs/ Levers /Light Commercial	F10/F40 Levers/ Knobs	16-080	x	1" x 2-1/4" Dual Option - Round Corner + Drive-in (Standard Configuration)	\$18.40	NC
		16-203	x	1" x 2-1/4" Square Corner Faceplate + Firecup + 1-1/8" Adaptor – UL Listed for 3 hour fire door	*	\$7.00
		16-204	x	1" x 2-1/4" Radius Corner Faceplate + Firecup + 1-1/8" Adaptor – UL Listed for 3 hour fire door	*	\$7.00
		16-200	x	1" x 2-1/4" Square Corner Faceplate	\$16.90	NC
		16-210	x	1" x 2-1/4" Triple Option - Round Corner + Square Corner + Drive-in	\$20.80	\$3.00
		40-250	x	1" x 2-1/4" Triple Option - Round Corner + Square Corner + Drive-in VisPack ONLY (order in qty's of 4)	\$25.00	N/A
FC Knobs/Levers	FC21/FC285	16-601	x	1" x 2-1/4" Triple Option - Round Corner + Square Corner + Drive-in	\$23.30	NC
		16-620	x	1" x 2-1/4" Square Corner Faceplate + Firecup - UL Listed for 3 hour fire door	*	\$7.00
		16-621	x	1" x 2-1/4" Round Corner Faceplate + Firecup - UL Listed for 3 hour fire door	*	\$7.00

* Sold with complete UL lockset; not available for individual purchase.

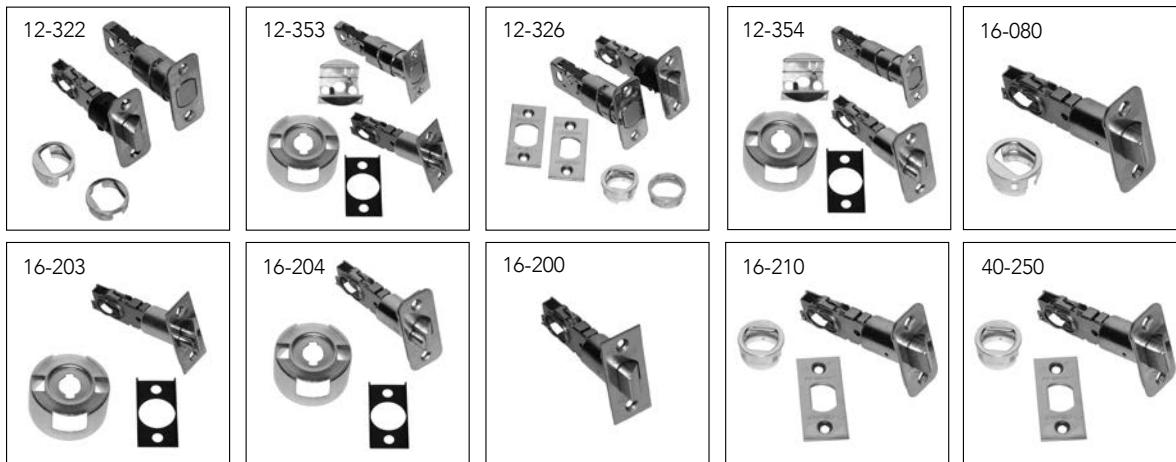

F Series Parts
Latches
LATCHES CONT. (does not include Multi-Family product)

Category	Product	Part Number	Specify Finish	Description	Price Sold Separately	Add To Lock Price
F Series Knobs/Levers / Light Commercial (cont.)	F51A/F80 Levers/Knobs	16-086	x	1" x 2-1/4" Dual Option - Round Corner + Drive-in (Standard Configuration)	\$21.60	NC
		16-207	x	1" x 2-1/4" Square Corner Faceplate	\$19.60	NC
		16-211	x	1" x 2-1/4" Triple Option - Round Corner + Square Corner + Drive-in	\$24.70	\$3.00
		16-203	x	1" x 2-1/4" Square Corner Faceplate + Firecup + 1-1/8" Adaptor - UL Listed for 3 hour fire door	*	\$7.00
		16-204	x	1" x 2-1/4" Radius Corner Faceplate + Firecup + 1-1/8" Adaptor - UL Listed for 3 hour fire door	*	\$7.00
		16-126	x	1" x 2-1/4" Square Corner Faceplate - 5" Backset	\$18.50	\$7.00
		40-251	x	1" x 2-1/4" Triple Option - Round Corner + Square Corner + Drive-in VisPack ONLY (order in qtls of 4)	\$25.00	N/A
B Series	B60/B62/B80/B81	12-321	x	1" x 2-1/4" Dual Option-Round Option + Drive-In (Standard Configuration)	\$41.90	NC
		12-288	x	1" x 2-1/4" Square Corner Faceplate	\$49.50	NC
		12-287	x	1" x 2-1/4" Triple Option - Round Corner + Square Corner + Drive-in	\$57.40	\$3
		12-294	x	1" x 2-1/4" Square Corner Faceplate + Firecup UL Listed for 3 hour fire door (B60/B80/B81 only)	*	\$7
		12-349	x	1" x 2-1/4" Square Corner Faceplate - 5" backset	\$81.90	N/A
		12-355	x	Tapered Deadbolt Triple Option	\$46.60	\$3.00
		12-397	x	1" x 2-1/4" Round Corner Faceplate + Firecup UL Listed for 3 hour fire door (B60/B80/B81 only)	*	\$7.00

* Sold with complete UL lockset; not available for individual purchase.

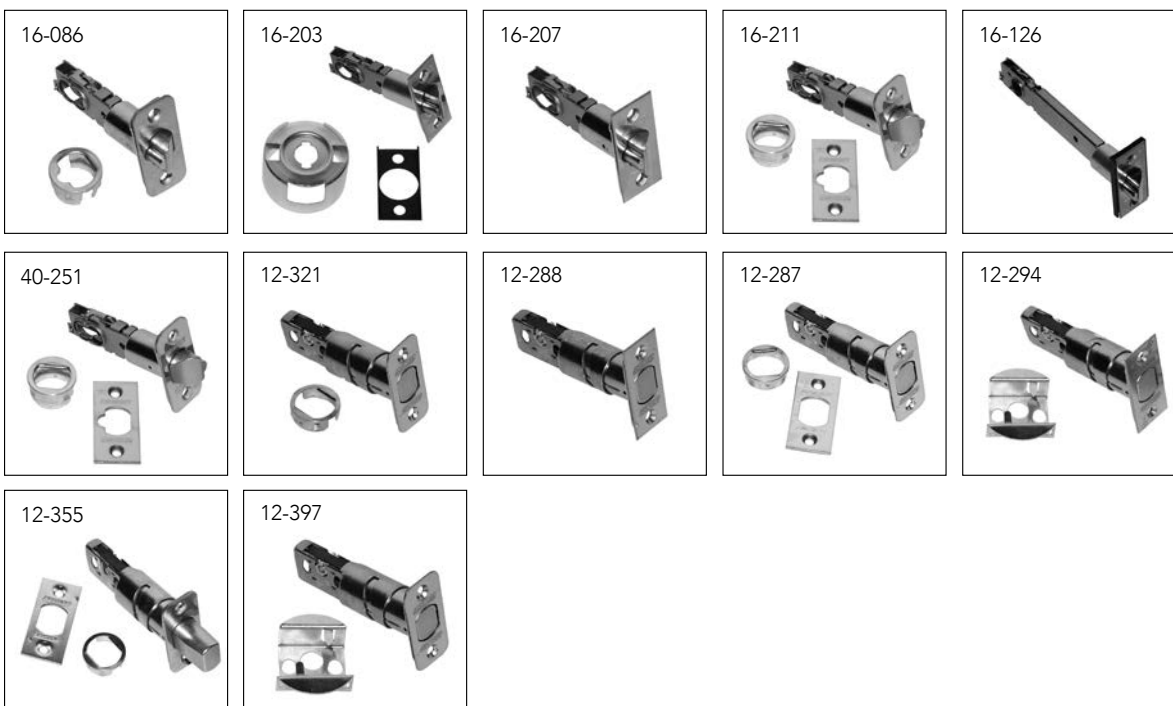

Strikes
F Series Parts

STRIKES (does not include Multi-Family product)

Category	Product	Part Number	Specify Finish	Description	Price Sold Separately	Add To Lock Price	
Electronics/ Connected & Light Commercial	BE469NX/ BE369NX/ BE375/BE365/ BE468/ BE489	10-116	x	Round Corner Integrated Strike and Reinforcer 1-1/8" x 2-3/4" (Standard Configuration)	\$18.60	NC	
		10-115	x	Round Corner Full Lip Strike Set (10-027 + 10-116) (Round, Square, Drive-in) (Standard Configuration-Entry Sets)	\$23.70	NC	
		B502-914		Reinforcement Strike Plate	\$2.60	N/A	
		B502-873		3" Reinforcement Screws (2 ea.)	\$0.77	N/A	
		B502-886	x	3" Plated Reinforcement Screws (2 ea.)	\$0.79	NC	
		All strikes available for B60/B62/B80/B81					
	FE695/FE595/ FE575/ FE285	10-027	x	10-027 Round Corner Full Lip Strike 1-5/8" x 2-1/4" (Standard Configuration)	\$10.50	NC	
All strikes available for F10/F40/F51/F80 Levers/Knobs							
F Series Handlesets	F59/F60/F62	10-115	x	Round Corner Full Lip Strike Set (10-027 + 10-116) (Standard Configuration)	\$23.70	NC	
		10-257	x	Round Corner Full Lip (10-027 + 10-092)	\$19.40	NC	
		10-269	x	Round & Square Corner Strike Set (10-026 + 10-027 + 10-047 + 10-116)	\$30.50	NC	
		B502-914		Reinforcement Strike Plate	\$2.60	N/A	
		B502-873		3" Reinforcement Screws (2 ea.)	\$0.77	N/A	
		B502-886	x	3" Plated Reinforcement Screws (2 ea.)	\$0.79	NC	

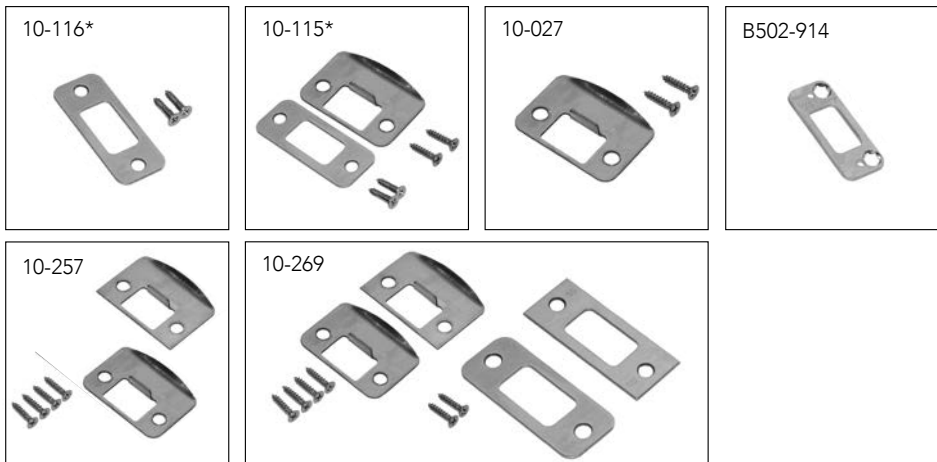

* Picture represents what is provided when ordered with a lock. When purchasing accessories, the kit includes strike plate and screws only. Reinforcement strike plate and reinforcement screws need to be purchased separately.

F Series Parts
Strikes
STRIKES CONT. (does not include Multi-Family product)

Category	Product	Part Number	Specify Finish	Description	Price Sold Separately	Add To Lock Price
F Series Knobs/ Levers/Light Commercial	F10/F40/F51A/ F80/FC21 Levers/ Knobs	10-027	x	10-027 Round Corner Full Lip Strike 1-5/8" x 2-1/4" (Standard Configuration)	\$10.50	NC
		10-026	x	Square Corner Full Lip Strike 1-5/8" x 2-1/4"	\$10.50	NC
		10-001	x	10-001* Square Corner T Strike 1-1/8" x 2-3/4" + Box	\$9.00	NC
		10-058	X	Circular - Adjustable 1-3/4" Diameter (605 and 626 finish only)	\$16.70	NC
		10-063	x	Dual Strikes (10-026 + 10-027) 1-5/8" x 2-1/4"	\$12.50	NC
		10-025	x	ANSI Square Corner T Strike 1-1/4" x 4 7/8"	\$21.60	\$7.00
		B Series Deadbolts/ Light Commercial	B60/ B62/B80/B81	10-116	x	Round Corner Integrated Strike and Reinforcer 1-1/8" x 2-3/4" (Standard Configuration)
10-147	x			Square Corner Integrated Strike and Reinforcer 1-1/8" x 2-3/4"	\$15.30	NC
47465560	x			Round Corner Strike Plate (Old Style) 1-1/8" x 2-3/4"	\$18.60	N/A
10-094	x			Square Corner Strike Plate (Old Style) 1-1/8" x 2-3/4"	\$16.80	N/A
B502-914				Reinforcement Strike Plate	\$2.60	N/A
B502-873				3" Reinforcement Screws (2 ea.)	\$0.77	N/A
B520-283				Black Plastic Dustbox for Standard Strike 1-1/8" x 2-3/4"; 3" Reinforcement Screws (2 ea.)	\$2.60	NC
B520-886	x			3" Plated Reinforcement Screws (2 ea.)	\$0.79	NC
10-112				Metal Dust Box	\$16.70	N/A
10-092				Full lip strike radius	\$10.80	NC

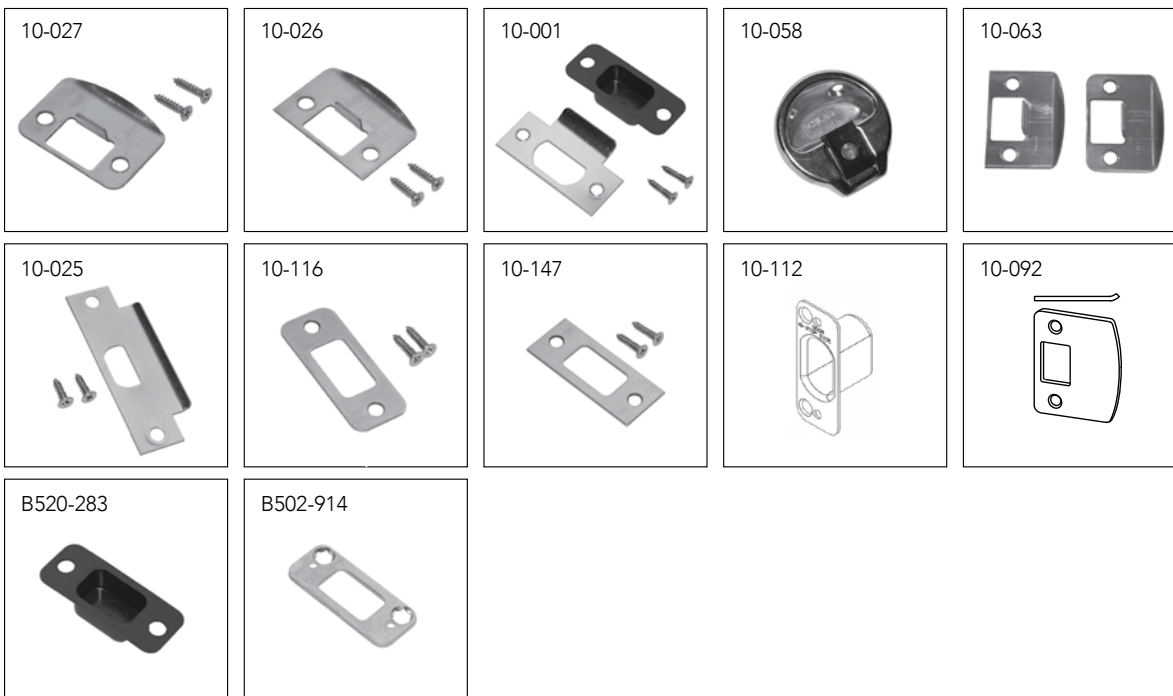

Cylinders
F Series Parts

CYLINDER PINS

Part Number	Description	Price
34-101*	Top Pin - #1	\$0.10
34-102*	Top Pin - #2	\$0.10
34-103*	Top Pin - #3	\$0.10
34-202*	Master Pin - #2	\$0.10
34-203*	Master Pin - #3	\$0.10
34-204*	Master Pin - #4	\$0.10
34-205*	Master Pin - #5	\$0.10
34-206*	Master Pin - #6	\$0.10
34-207*	Master Pin - #7	\$0.10
34-208*	Master Pin - #8	\$0.10
34-209*	Master Pin - #9	\$0.10
34-300*	Bottom Pin - #0	\$0.10
34-301*	Bottom Pin - #1	\$0.10
34-302*	Bottom Pin - #2	\$0.10
34-303*	Bottom Pin - #3	\$0.10
34-304*	Bottom Pin - #4	\$0.10
34-305*	Bottom Pin - #5	\$0.10
34-306*	Bottom Pin - #6	\$0.10
34-307*	Bottom Pin - #7	\$0.10
34-308*	Bottom Pin - #8	\$0.10
34-309*	Bottom Pin - #9	\$0.10

* Order in multiples of 100.

REKEY PARTS

Part Number	Description	Price
F506-451*	Top T Pin - Compressible F Series	\$0.15
F506-452*	Removable Top Cap - Compressible F Series	\$0.24
F506-453*	Top T Pin Spring - Compressible F Series	\$0.24
34-401	Construction Balls (Pack of 1000)	\$44.10
40-104	Key Gauge	\$20.90
M540-051	Follower Bar	\$4.60
M540-056	Cylinder Cap Removal Tool	\$81.40
40-132	Retail Metal ReKey Kit	\$335.00
40-133	Home Secure RCK ReKey Kit	\$576.00
40-229	Rekeying Training Kit	\$129.00

* Order in multiples of 100.

F Series Parts
ASSEMBLY SCREW KITS (does not include Multi-Family product)

Category	Product	Part Number	Specify Finish	Description	Price	
Connected	BE489	BE489-108	x	Kit, Screws, BE489	\$6.30	
	BE469NX/468	24283962	x	Screw Kit, Mtg Screws & Wood Screws	\$6.10	
	BE369NX/BE375 BE365	B220-279	x	(2) B520-621 Finish Screws (2) B600-100 Internal Screws	\$13.40	
Electronic/ Light Commercial	FE595/FE575	F206-450	x	Mtg Screw Kit	\$7.20	
	FE285	F206-450	x	Mtg Screw Kit	\$7.20	
		F506-828			(1) Through Bolt for Handleset Grip	\$1.60
		F605-339			(1) Washer for Handleset Grip	\$0.70
B Series Deadbolts/F Series Knobs & Levers/ F Series Handlesets /FC Series Knobs & Levers	B60	33815664	605	Screw Kit, Mtg. Screws, Strike Reinforcement	\$12.60	
		33815671	625	Screw Kit, Mtg. Screws, Strike Reinforcement	\$12.60	
		33815688	716	Screw Kit, Mtg. Screws, Strike Reinforcement	\$12.60	
	B62	33815725	605	Screw Kit, Mtg. Screws, Strike Reinforcement	\$12.60	
		33815732	625	Screw Kit, Mtg. Screws, Strike Reinforcement	\$12.60	
		33815749	716	Screw Kit, Mtg. Screws, Strike Reinforcement	\$12.60	
	B80	33815756	605	Screw Kit, Mtg. Screws, Strike Reinforcement	\$12.60	
		33815763	625	Screw Kit, Mtg. Screws, Strike Reinforcement	\$12.60	
		33815770	716	Screw Kit, Mtg. Screws, Strike Reinforcement	\$12.60	
	F60	33815787	605	Screw Kit, Mtg. Screws, Strike Reinforcement	\$12.60	
		33815794	625	Screw Kit, Mtg. Screws, Strike Reinforcement	\$12.60	
		33815800	716	Screw Kit, Mtg. Screws, Strike Reinforcement	\$12.60	
	F62	33815817	605	Screw Kit, Mtg. Screws, Strike Reinforcement	\$12.60	
		33815824	625	Screw Kit, Mtg. Screws, Strike Reinforcement	\$12.60	
		33815831	716	Screw Kit, Mtg. Screws, Strike Reinforcement	\$12.60	
	F10/F40/F51A	33815848	605	Screw Pack	\$12.60	
		33815855	625	Screw Pack	\$12.60	
		33815862	716	Screw Pack	\$12.60	
	F170	33815879	605	Screw Pack	\$12.60	
		33815886	625	Screw Pack	\$12.60	
		33815893	716	Screw Pack	\$12.60	
FC21	40-346	x	Wood Screw (order in multiples of 100)	\$12.60		

Thick Door Installation Kits
Miscellaneous Parts

THICK DOOR INSTALLATION KITS (does not include Multi-Family product)

Category	Product	Part Number	Finish	Description	Price
Connected	BE468/469	23997877	x	1-7/8" – 2-1/2" Thick Door	\$31.20
	BE489	BE489-106	x	1-7/8" – 2-1/2" Thick Door	\$31.20
Electronic/ Light Commercial	BE365	02-007	x	1-7/8" – 2-1/2" Thick Door	\$31.20
Touch	BE375	24666356	x	1-7/8" – 2-1/2" Thick Door	\$31.20
F Series Handlesets	F58 (old)	61-075	x	1-7/8" – 2-1/4" - Includes mounting screws, thick door grip chassis, and thick door driver bar (Used for Old Style F58 shipped before 3/1/19)	\$18.90
	F58(new)/F60	61-076	x	1-7/8" – 2-1/4" - Includes mounting screws and thick door driver bar (Used for New Style F58 shipped after 3/1/19)	\$15.00
	FE285	61-076	x	1-7/8" – 2-1/4" - Thick Door	\$15.00
B Series Deadbolts/ Light Commercial	B60	61-072	x	1-7/8" – 2-1/4" - Includes longer mounting screws only for deadbolt	\$6.30
		61-073	x	2-1/4" – 4" - Includes longer mounting screws and longer driver bar	\$12.50

FC MISCELLANEOUS PARTS

Category	Part Number	Specify Finish	Description	Price
FC 21	40-340	x	Privacy Button 07-240-002 (order in multiples of 25)	\$3.00
	40-341		Emergency Pin F720-006 (order in multiples of 100)	\$0.09
	40-343		Set Screw for levers/knobs F720-001 (order in multiples of 100)	\$0.45
	40-342		Hex Key F720-004 (order in multiples of 100)	\$0.26

MISCELLANEOUS PARTS

Category	Specify Finish	Description	Price
B202-578	x	Latch/Bolt/Strike Screw Kit(4) C603-897 Latch/Bolt/Strike Wood Screw	\$11.60
M504-271		(Emergency Key) F40 Function	\$2.40
02-035	x	Through Bolt Cap for Handleset Grip	\$1.90
06-133	x	Handleset Slider Assembly	\$2.60
B300-060	x	F62 & B62 Drive Pins (2 deadbolt screw covers)	\$1.60
B302-043	x	Housing, Cylinder outside – conventional	\$39.30
F506-828		(1) Through Bolt for Handleset Grip	\$1.60
F605-339		(1) Washer for Handleset Grip	\$0.70

LESS LOCK COMPONENTS

Description	Specify	Price adjustment*
Less Spring latch	LLL for Spring latch	-\$5.20
Less Deadlatch	LLL for Deadlatch	-\$5.80
Less Handleset Deadbolt	LLL for Handleset Deadbolt	-\$10.40
Less Handleset Deadbolt Strike	LLL for Handleset Deadbolt Strike	-\$4.20
Less Handleset Latch Strike	LLL for Handleset Latch Strike	-\$2.80
Less Deadbolt	LLL for Deadbolt	-\$10.40
Less Deadbolt Strike	LLL for Deadbolt Strike	-\$4.20
Less Knob Strike	LLL for Knob Strike	-\$2.80
Less Lever Strike	LLL for Lever Strike	-\$2.80

* Subtract from price of lock.

F Series Parts
35 - BLANK KEYS

Part No.	Description	Price
35-100*	5-pin - Standard Bow - Embossed Both Sides	\$2.20
35-101*	6-pin - Standard Bow - Embossed Both Sides	\$2.70
35-130*	5-pin - Standard Bow - Unembossed Both Sides - No Stamping	\$2.20
35-131*	6-pin - Standard Bow - Unembossed Both Sides - No Stamping	\$2.70
35-140	5-pin - Large Bow - Embossed Both Sides	\$7.00
35-141	6-pin - Large Bow - Embossed Both Sides	\$7.40
35-143	5-pin - Access Bow - Embossed Both Sides	\$7.00
35-144	6-pin - Access Bow - Embossed Both Sides	\$7.40

* Order in multiples of 50.

48 - CUT KEYS

Part No.	Description	Price
48-130	Cut Key - 5-pin - Standard Bow - Unembossed Both Sides - No Stamping	\$8.90
48-140	Cut Key - 5-pin - Large Bow - Embossed Both Sides	\$14.10
48-143	Cut Key - 5-pin - Access Bow - Embossed Both Sides	\$14.10
48-180*	Cut Key - 5-pin - Standard Bow - Embossed Both Sides / Construction Key	\$7.80
48-181	Cut Key - 6-pin - Standard Bow - Embossed Both Sides	\$7.80

* 48-180 is used for standard cut keys and residential construction keys.

49 - MASTER KEYS

Part No.	Description	Price
49-130	Master Key - 5-pin - Standard Bow - Embossed Both Sides	\$18.60
49-140	Master Key - 5-pin - Large Bow - Embossed Both Sides	\$24.00
49-143	Master Key - 5-pin - Access Bow - Embossed Both Sides	\$24.00
49-180	Schlage Cut Master Key - 5-Pin - Standard with Key Symbol & Registry Number	\$15.60
49-181	Master Key - 6-pin - Standard Bow - Unembossed Both Sides - Standard with Key Symbol & Registry Number	\$13.00

50 - KEY CHARGES

Part No.	Description	Price adder
50-001	Conventional Cylinder Keyed to Specific Combination	\$14.00
50-215	Extra Cut Standard Bow Keys Ordered on Lock or Cylinder	\$6.00
50-227	Extra Cut Large or Access Bow Keys Ordered on Lock or Cylinder	\$9.30
50-228	Cut Large Bow or Access Bow Keys Substituted for Standard Bow Keys	\$4.20

* Key Charges are added to the list price of the lock.

60 - KEY PACKAGING

Part No.	Description	Price
60-000	Pack Change Keys Independently (PKI) - for Split Key Construction Keying	NC
60-001	Pack Change Keys Independently (PKI)	\$0.81

Key & Cylinder Stamping

Residential Master & Construction Keying

F Series Parts

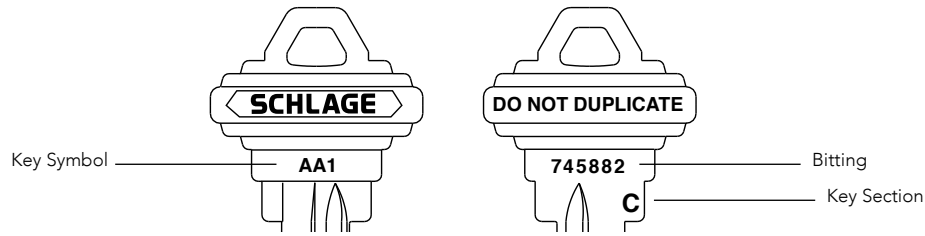
KEY STAMPING AREA

KEY STAMPING

Description	Notes	Key Type	Specify	Part Number	Price Ea. Key
Visual Jey Control (VKC)	1	Classic Conventional	Stamp Key Symbol on Key	50-217	\$4.00
Non-Standard Code	1, 2, 3	All Conventional	Non-Standard Code	50-003	\$10.30/side
DO NOT DUPLICATE		Classic Conventional	Stamp Key "Do Not Duplicate"	XQ06-878	NC
Delete Key Section From Bow	4	Classic Conventional	Delete Key Section	50-220	\$7.10
Bitting Not Stamped		Classic Conventional	Delete Key Combination	50-221	\$4.00
Stamp Bitting		Classic Conventional	(Furnished as Standard)	N/A	N/A

Notes:

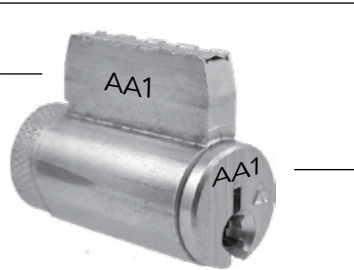
1. Maximum of 6 characters for VKC, Non-Standard Code or serial number stamping
2. Only available on unembossed keys
3. Sequential stamping will be charged as Non-Standard Code (example: AA1-1, AA1-2)
4. Not available with 48 Cut Keys.

CYLINDER STAMPING AREA

KEY STAMPING

Description	Notes	Key Type	Specify	Part Number	Price Ea. Key
Visual Key Control (VKC) with standard key symbols or Non-standard codes	1	Classic Conventional	Stamp key symbol or non-conventional code on face (VKC) or Cylinder core.	50-002	\$9.50
Concealed Key Control (CKC) with standard key symbols or Non-standard codes	1	Classic Conventional	Stamp key symbol or non-conventional code on side (CKC) of core.	50-216	\$9.50

Notes:

1. Maximum of 6 characters for VKC, Non-Standard Code or serial number stamping.

B and F Series Mechanical Locks
 BE and FE Series Electronic Locks

RESIDENTIAL MASTER KEYING (RMK) AND/OR RESIDENTIAL CONSTRUCTION KEYING (RCK)

Qualifications:

- Residential projects
- RMK and/or RCK must be specified on the order
- **Systems are available in 5-Pin C keyway only**
- Systems cannot be combined with Contract Master Key Systems
- **Two levels of keying (Change Key and Master Key levels only)**
- **Three levels of keying allowed if complete expansion requirements are submitted (Grandmaster, Master Key, and Change Key levels)**
- Maison keying allowed
- Door detailing and labeling allowable as listed below
- Master keys must be ordered separately and are not added by default

RESIDENTIAL MASTER KEYING (RMK)

Part No.	Description	Price
50-223*	Cylinder Residential Master Keyed (RMK)	\$3.30
50-009	Cylinder Residential Master keyed with Door ID Labeling (RMKID)	NC
49-180	Residential Master Key – Not offered for commercial products	\$15.60

* If Door Labeling is required, the 50-009 RMK with labeling and/or 50-010 RCK with labeling charges will apply.

Residential Construction Keying (RCK) – Lost Ball Construction Keying

Part No.	Description	Price
50-224*	Cylinder Residential Construction Keyed (RMK)	\$3.30
50-010	Cylinder Residential Construction keyed with Door ID Labeling (RCK)	NC
48-180	Residential Construction Key – Not offered for commercial products	\$7.80

Notes: Lost ball construction device is triggered by the highest level permanent key unless otherwise specified.
 Change keys packed in envelopes and packed in lock box. PKI packing available for additional charge of \$0.81.
 If you desire a masterkey with your RCK (50-224), you must add the RMK (50-223) charge listed above.

* If Door Labeling is required, the 50-009 RMK with labeling and/or 50-010 RCK with labeling charges will apply.

Master Keys and Construction Keys ship UPS 2nd Day Air and will require a signature upon delivery. Standard freight terms apply.

BITTING LISTS (TRANSCRIPTS)

Part No.	Description	Price
50-123**	Bitting list for factory master keyed products (requires a written authorization from end-user).	\$332.00
50-120	Establish new master key system for field master keying (one-time charge). Each bitting is assessed a 50-121 or 50-122 charge below.	\$49.20
50-121	New master key bitting for cylinders keyed in the field. 50-120 charge assessed if this bitting establishes a new system.	\$6.20
50-122	New change key bitting for cylinders keyed in the field.	\$4.90

**Can be used for SiteMaster download (keying and bitting details) if ordered as such. Please specify SiteMaster download file if applicable in the details column.
 Information required: Structure or original order number, end user name, city and state (used to verify the structure number). Also required is an email address for the end user, include their full name to address the email and a "Letter Of Authorization".

Construction Core Program

F Series Parts

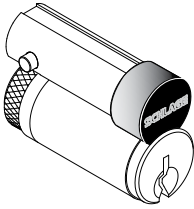

23-030-ICX

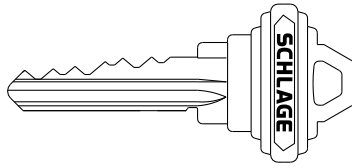

48-101-ICX

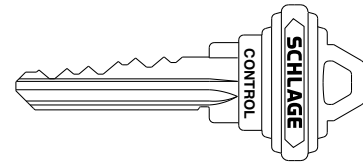

48-056-ICX

FULL-SIZE CONSTRUCTION CORE PROGRAM

Temporary construction cores may be ordered with full size interchangeable core locks, mortise cylinders and rim cylinders. These cores may also be ordered separately. All construction cores are assessed a non-refundable handling charge of \$14.40 (50-231). See Terms & Conditions for more information.

Features:

- 6-pin C keyway
- Construction cores have a two-tone face: the faceplate is a flat black finish (622) and the plug is unfinished brass.
- Back of each core is marked with the letter that identifies the keyed alike group: A, B or C
- Construction cores are furnished with no keys (NCK). Cut keys must be ordered separately.
- A control key is required to install and remove construction cores. Control keys must be ordered separately. If a control key is not ordered, one will be supplied at a charge of \$13.00
- Construction cores may be returned for credit. Contact your Schlage representative for return authorization. Credit is issued upon receipt of cores at our factory.

Part No.	Description	Specify	Price (ea.)
23-030-ICX	Construction core	New jobs: Specify "ICX"	\$102.00
48-101-ICX	Cut key for construction phase (order separately)	Existing jobs: Specify "ICA"	\$9.40
48-056-ICX	Cut control key (order separately)	"ICB" or "ICC"	\$18.30
50-231	Non-refundable handling charge (per core)	-	\$14.40

Notes:

- 1) To order mortise and rim cylinders with full-size construction cores for a new job, suffix ICX to non-Primus cylinder number
Example: 30-008 ICX. For existing construction core combinations, specify ICA, ICB, or ICC
- 2) Construction cores for a given project are keyed alike to one of a limited number of combinations nationwide
Other Schlage projects in the same area using the same or different contractors may use the same key

Example: For construction core charges and credits: distributor XYZ ordered 150 construction cores with 20 keys and one control key
The following charges apply to this order:

1. 23-030-ICX construction cores (150 units)
2. 48-101-ICX cut keys (20 units)
3. 48-056-ICX cut control key (1 unit)
4. 50-231 non-refundable handling charge (150 units-one per core ordered)

Upon return of the cores to the factory the distributor will be credited for the following:

1. 23-030-ICX construction cores (150 units)

There is no credit for the keys or handling fee.

B60 Cylinder Options

FINISHES

	605	505	608	609	618	619	620	621	622	625	626	716
B60J B60 less IC core	•	\$116	\$116	•	\$116	\$116	•	•	•	•	\$116	\$116
B60T B60 with Full Size Construction core	•	\$176	\$176	•	\$176	\$176	•	•	•	•	\$176	\$176

J Series Parts
Latches



16-254
16-256



16-255



16-068

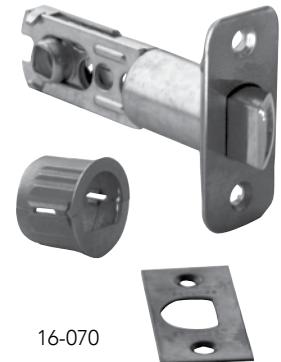

16-070

LATCHES

FINISHES

Function	Pkg.	Style/Design	605	609	619	620	625	626	630	716
16-254	Poly Bag	Dual Option Adjustable Spring Latch	\$8.20	\$8.20	•	•	•	•	\$8.20	\$8.20
16-256	Poly Bag	(NEW) Dual Option 45-Degree Adjustable Lever Spring Latch	\$8.20	\$8.20	•	•	•	•	\$8.20	\$8.20
16-255	Poly Bag	Triple Option Adjustable Dead Latch	\$11.20	\$11.20	•	•	•	•	\$11.20	\$11.20
16-068	Poly Bag	Triple Option Adjustable Deadbolt Latch	\$11.50	\$11.50	•	•	•	•	\$11.50	\$11.50
16-070	Poly Bag	Triple Option Adjustable Spring Latch	\$11.20	\$11.20	•	•	•	•	\$11.20	\$11.20
16-059*	Poly Bag	UL-Spring latch, for J10F 2-3/8" or 2-3/4" (Square Corner)	\$7.00	\$7.00	•	•	•	•	\$7.00	\$7.00
16-061*	Poly Bag	UL-Deadlatch, for J54F 2-3/8" or 2-3/4" (Square Corner)	\$7.00	\$7.00	•	•	•	•	\$7.00	\$7.00
16-063*	Poly Bag	UL-Deadbolt, for JD60F, JD80F, JD81F 2-3/8" or 2-3/4" (Square Corner)	\$7.00	\$7.00	•	•	•	•	\$7.00	\$7.00
16-057*	Poly Bag	UL-Spring latch 16-059 and UL-Deadbolt 16-063 for JH59 and JI19	\$14.00	\$14.00	•	•	•	•	\$14.00	\$14.00

* Sold with complete UL lockset; not available for individual purchase.

Notes:

1. The 16-256 latch kit is a replacement for J10/J40 lever latches marked with a "J."

Marked with "J"

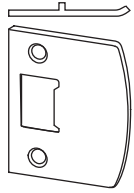

Marked with "J"

Strikes
J Series Parts

10-100

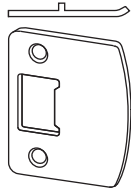

10-101

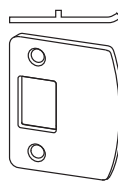

10-102

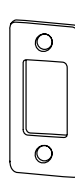

10-103

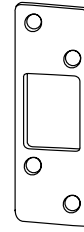

10-104

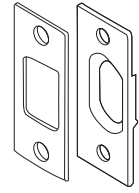

10-099

STRIKES
FINISHES

Part No. w/Lock	Part. No. Sold Separately	Style/Design	605	609	619	620	625	626	630	716
10-100*	J250-008	Poly Bag , Square Full Lip Strike Knobs and Levers Including 2 Screws	\$2.60	\$2.60	\$2.60	\$2.60
10-101	J250-009	Poly Bag , Radius Full Lip Strike Knobs and Levers Including 2 Screws	\$2.60	\$2.60	\$2.60	\$2.60
10-102	J250-010	Poly Bag, Radius Full Lip Strike Deadbolts Including 2 Screws	\$2.60	\$2.60	\$2.60	\$2.60
10-103	J250-026	Poly Bag, Radius Deadbolt Strike 1" x 2-1/4" Round Corner	\$2.60	\$2.60	\$2.60	\$2.60
10-104*	J250-027	Poly Bag, Radius Deadbolt Strike 1-1/4" x 3 5/8" Round Corner	\$3.00	\$3.00	\$3.00	\$3.00
10-099	J250-003	Poly Bag , Sq. Strike Plate & Strike Frame Reinforcer 1-1/8" x 2-3/4" Square Corner Deadbolts Including 2 Screws + 2 x 3" Screws	\$3.00	\$3.00	\$3.00	\$3.00

* Item is only available as a part, not available with the lock.

J Series Parts
REKEYING PINNING PARTS & ACCESSORIES

Function	Style Design	Price
J750-002	#1 Top Pin, 200 pcs/per poly bag	\$0.10
J750-003	#2 Top Pin, 200 pcs/per poly bag	\$0.10
J750-004	#3 Top Pin, 200 pcs/per poly bag	\$0.10
J750-005	#0 Bottom Pin, 200 pcs/per poly bag	\$0.10
J750-006	#1 Bottom Pin, 200 pcs/per poly bag	\$0.10
J750-007	#2 Bottom Pin, 200 pcs/per poly bag	\$0.10
J750-008	#3 Bottom Pin, 200 pcs/per poly bag	\$0.10
J750-009	#4 Bottom Pin, 200 pcs/per poly bag	\$0.10
J750-010	#5 Bottom Pin, 200 pcs/per poly bag	\$0.10
J750-011	#6 Bottom Pin, 200 pcs/per poly bag	\$0.10
J750-012	#7 Bottom Pin, 200 pcs/per poly bag	\$0.10
J750-013	#8 Bottom Pin, 200 pcs/per poly bag	\$0.10
J750-014	#9 Bottom Pin, 200 pcs/per poly bag	\$0.10
J750-015	#2 Master Pin, 200 pcs/per poly bag	\$0.10
J750-016	#3 Master Pin, 200 pcs/per poly bag	\$0.10
J750-017	#4 Master Pin, 200 pcs/per poly bag	\$0.10
J750-018	#5 Master Pin, 200 pcs/per poly bag	\$0.10
J750-019	#6 Master Pin, 200 pcs/per poly bag	\$0.10
J750-020	#7 Master Pin, 200 pcs/per poly bag	\$0.10
J750-021	#8 Master Pin, 200 pcs/per poly bag	\$0.10
J750-022	#9 Master Pin, 200 pcs/per poly bag	\$0.10
J750-023	Pin Tumbler Key Gauge	\$4.70
J750-024	Plug Clip, 50 pcs/per poly bag	\$0.06
J750-025	Pin Spring, 100 pcs/per poly bag	\$0.15
J750-026	Cylinder Cap, 50 pcs/per poly bag	\$0.15
J750-027	Deadbolt Spring, 100 pcs/per poly bag	\$0.15
J750-028	Deadbolt Cap Pin, 100 pcs/per poly bag	\$0.06
J750-029	Follower Tool	\$5.20
J750-030	Cylinder Removing Tool	\$4.30
J750-001	RCK Lost Balls, 200 pcs/per poly bag	\$0.04
J250-029	Spanner Wrench for removing cylinder face	\$1.38

Key Kits

J250-006	Master Rekeying Kit	\$209.00
J250-007	Retail Key Kit	\$169.00



J Series Parts

HANDLESET THROUGHBOLT KITS

FINISHES

Function	Style/Design	605	609	619	620	622	625	626	630	716
J250-036	Handleset Throughbolt Kit - throughbolt screw, washer, and cap	\$2.90	\$2.90	•	\$2.90	\$2.90	•	•	\$2.90	\$2.90

- Ordering part includes interior and exterior tailpiece.

Note: 630 throughbolt cap also used for 619/625/626.



J Series Mechanical Locks

JBE and JFE Series Electronic Locks

- Master keys must be ordered separately and are not added by default

REKEYING PINNING PARTS & ACCESSORIES

Function	Style Design	Price
Keys Ordered with Locks or Cylinders		
50-001	Lock Keyed to a Specific Combination	\$14.00
50-215	Extra Cut Keys Ordered on Lock with Cylinder	\$6.00

Residential Master Keying (RMK)

50-223	Cylinder Residential Master Keyed	\$3.30
49-155	Residential Master Key	\$13.10

Residential Construction Keying (RCK)

50-224	Cylinder Residential Construction Keyed	\$3.30
48-155*	Residential Construction Key	\$7.80

* 48-155 is used for standard cut keys and residential construction keys.

Key Blanks

J750-061	5-Pin Standard Bow, Embossed Both Sides, No Stamping, C-Section Only (order in quantities of 50)	\$1.00
----------	--	--------

Padlocks	101
Cables & Chains	102
Security Hasps	104

Padlocks

 KS43F
Brass Padlock

 KS72F
Steel Padlock

Commercial Security - Rekeyable Padlocks

UPC	Part number	Description	Shackle Height (in.)	Shackle Cable Link Dia. (in.)	Size (in.)	Size (mm)	Price
720018997412	KS23D2300	Brass Padlock 23 Series, K-N-K Cyl 1-1/2" Shackle, KD	1-1/2	5/16	1-25/32	45mm	\$77.50
720018997405	KS23F2300	Brass Padlock 23 Series Brass K-N-K Cyl 2" Shackle, KD	2	5/16	1-25/32	45mm	\$77.70
720018997290	KS43D2300	Brass Padlock 43 Series Brass K-N-K Cyl 1-1/2" Shackle, KD	1-1/2	3/8	1-15/16	50mm	\$82.50
720018997283	KS43F2300	Brass Padlock 43 Series Brass K-N-K Cyl 2" Shackle, KD	2	3/8	1-15/16	50mm	\$83.00
720018997764	KS72F2300	Steel Padlock - 72 Round body, K-N-K Cyl 2", KD	2	7/16	2-5/8	67.5mm	\$89.30

 850410
Laminated Padlock

 855156
Steel Padlock

 851226
Steel Padlock

FlexSecurity - Non Rekeyable Padlocks

UPC	Part number	Description	Shackle Height (in.)	Shackle Cable Link Dia. (in.)	Size (in.)	Size (mm)	Price
720018850410	850410	Covered Laminated Steel Padlock, 2 Pack - KA	1-1/8	1/4	1-1/2	38mm	\$33.40
720018999232	999232	Extra Large "U" Steel Padlock 4" x 11", - KD	11	1/2	7-1/8	181mm	\$47.10
720018855156	855156	Shackle-less Steel, Round body Padlock - KD	•	3/8	2-7/8	73mm	\$60.60
720018851226	851226KA	Steel Padlock, Round body 2" Shackle - KA	2	7/16	2-1/2	63.5mm	\$42.50
720018994831	994831	Steel Padlock, Round body 2" Shackle - KA, 2-Pack	2	7/16	2-1/2	63.5mm	\$59.10

Cables & Chains



999218
Locking Cable



994862
Double Looped
Cable & Padlock



999225
Locking Resettable
Combination Cable



001140
Locking Chain

FlexSecurity - Cables & Chains

UPC	Part number	Description	Shackle Cable Link Dia. (in.)	Loop Height (in.)	Loop Width (in.)	Chain/Cable Length (ft.)	Price
720018001140	001140	Locking Chain - 5' x 5/16" (7mm)	5/16	•	•	5	\$48.10
720018001157	001157	Locking Chain - 4' x 3/16" (5mm)	7/32	•	•	4	\$29.30
720018994800	994800	Double Looped Cable & Padlock - 4' x 3/8" with Covered Weather-proof Padlock	3/8	2-1/4	•	4	\$34.60
720018994862	994862	Double Looped Cable & Padlock - 15' x 3/8" with Covered Weather-proof Padlock	3/8	2-1/4	•	15	\$54.50
720018999218	999218	Locking Cable - 5' x 1/2"	1/2	•	•	5	\$37.00
720018999225	999225	Locking Resettable Combination Cable - 5' x 3/8"	3/8	•	•	5	\$38.40



999263
Double Loop Cable



999461
Cinch Chain

FlexSecurity - Double Looped Cables

UPC	Part number	Description	Shackle Cable Link Dia. (in.)	Loop Height (in.)	Loop Width (in.)	Chain/Cable Length (ft.)	Price
720018820406	820406	Double Looped Cable - 7' x 5/8"	5/8	•	3 3/8	7	\$48.30
720018999249	999249	Double Looped Cable - 4' x 3/8"	3/8	•	1-1/8	4	\$20.70
720018999256	999256	Double Looped Cable - 7' x 3/8"	3/8	•	1-1/8	7	\$26.40
720018999263	999263	Double Looped Cable - 15' x 3/8"	3/8	•	1-1/8	15	\$44.90
720018999270	999270	Double Looped Cable - 30' x 3/8"	3/8	•	1-1/8	30	\$72.10

FlexSecurity - Cinch Chains

UPC	Part number	Description	Shackle Cable Link Dia. (in.)	Loop Height (in.)	Loop Width (in.)	Chain/Cable Length (ft.)	Price
720018999461	999461	Cinch Ring Security Chain - 3' 3" - (No lock)	1/2	•	•	3.25	\$65.00
720018999478	999478	Cinch Ring Security Chain - 5' - (No Lock)	1/2	•	•	5	\$123.00

Security Hasps



855101

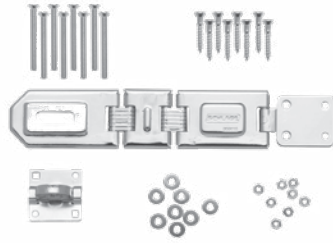

855118



FlexSecurity - Hasps

UPC	Part number	Description	Body Size (in.)	Body Size (mm)	Locking Eye Dia. (in.)	Price
720018855101	855101	Vehicle Security Hasp	8-1/2 x 4-1/2	21.6cm x 11.4cm	5/8	\$52.00
720018855118	855118	Flexible Double-Hinged Security Hasp	7-3/4 x 1-3/4	19.7cm x 4.4cm	1/2	\$16.60

How to Order	105
Retail Pack Carton Specifications	106

Thank you for your order.

Thank you for your order and continuing business. Please submit purchase orders to res_contact_center@allegion.com In order to expedite order processing, please include the following information on purchase orders:

- Schlage account number
- Product UPC numbers (if available)
- Quote number (if applicable)
- Specific keying requirements

Note: Line quantities of keyed products must be divisible by KA quantities.

Example: 20 locks ordered KA4 results in 5 groups of 4 locks keyed alike, however, 20 locks ordered KA3 is not divisible and results in order processing delays as Schlage seeks clarification

- Door handing

How to identify door handing:

Handing of all doors is determined from the exterior of the room’s entrance.

- If the hinge is on the left side of the door, the door is “left hand” (LH)
- If the hinge is on the right side of the door, the door is “right hand” (RH)
- To order a handed product, please specify LH or RH
- To order a handleset, handing is still determined from the exterior of the door
- We will use that information to determine the handing for the inside of the door

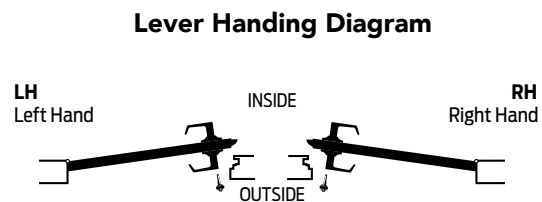

RETAIL PACK CARTON SPECIFICATIONS

PRODUCT	MASTER CARTON							INDIVIDUAL CARTON					
	PKG. TYPE	CASE QTY	HEIGHT (IN.)	WIDTH (IN.)	DEPTH (IN.)	CUBIC FEET	WEIGHT (LBS.)	PKG. TYPE	HEIGHT (IN.)	WIDTH (IN.)	DEPTH (IN.)	CUBIC FEET	WEIGHT (LBS.)
ELECTRONICS CONNECTED DEADBOLTS & LEVERS													
BE365	Box	2	10.05	5.90	12.60	0.43	9.87	Carton	9.30	5.25	6.19	0.17	4.75
BE375	Box	2	9.70	5.60	9.90	0.31	8.09	Carton	4.50	5.00	9.30	0.12	3.87
BE468	Box	2	9.75	5.60	10.10	0.32	9.05	Carton	9.25	4.50	5.00	0.12	4.35
BE469IR	Box	2	9.75	5.60	10.10	0.32	9.05	Carton	9.25	4.50	5.00	0.12	4.35
FBE365	Box	3	23.63	11.60	10.63	1.69	21.40	Carton	7.88	10.70	9.75	0.48	6.45
FBE375	Box	3	10.63	11.25	23.63	1.64	19.40	Carton	9.75	10.70	7.88	0.48	5.92
FE595	Box	2	10.00	7.00	16.88	0.68	10.29	Carton	9.25	8.25	6.63	0.29	4.86
FE695	Box	2	10.10	7.05	12.60	0.52	9.96	Carton	9.40	6.65	6.20	0.22	4.72

F SERIES HANDLESETS

F60 G	Box	1	16.0	8.5	6.25	0.492	8.00	Carton	14.63	7.75	5.5	0.361	8.0
FE285 G	Box	1	16.0	8.5	6.25	0.492	8.00	Carton	14.63	7.75	5.5	0.361	8.0

B SERIES DEADBOLTS

B60 G	Shroud	4	9.0	5.25	14.88	0.407	9.00	Carton	8.5	4.5	3.5	0.775	2.0
B62 G	Shroud	4	9.0	5.25	14.88	0.407	9.80	Carton	8.5	4.5	3.5	0.775	2.2
FB50 V	Shroud	4	10.125	8.875	15.625	0.81	17.20	Carton	9.5	7.875	3.625	0.16	3.60
FB52 V	Shroud	4	10.125	8.875	15.625	0.81	18.00	Carton	9.5	7.875	3.625	0.16	3.80

F SERIES KNOBS/LEVERS
Knobs

F10 V	Shroud	4	10.125	5.875	13.125	0.45	9.40	Carton	9.5	4.875	3.125	0.08	2.10
F40 V	Shroud	4	10.125	5.875	13.125	0.45	9.40	Carton	9.5	4.875	3.125	0.08	2.10
F51A V	Shroud	4	10.125	5.875	13.125	0.45	9.40	Carton	9.5	4.875	3.125	0.08	2.10
F170 V	Shroud	4	9.38	5.75	13.25	0.41	3.00	Carton	8.8	4.8	3.3	0.078	0.4

Levers

F10 V	Shroud	4	11.00	7.375	14.25	0.67	11.40	Carton	5.25	6.50	6.50	0.13	2.60
F40 V	Shroud	4	11.00	7.375	14.25	0.67	11.40	Carton	5.25	6.50	6.50	0.13	2.60
F51A V	Shroud	4	11.00	7.375	14.25	0.67	11.40	Carton	5.25	6.50	6.50	0.13	2.60
F170 V	Shroud	4	9.38	5.75	13.25	0.41	3.00	Carton	8.8	4.8	3.3	0.078	0.4

F SERIES DECORATIVE COLLECTIONS
Knobs

F10 V	Shroud	4	11.00	5.875	14.25	0.53	9.40	Carton	5.25	5.125	6.50	0.10	2.10
F40 V	Shroud	4	11.00	5.875	14.25	0.53	9.40	Carton	5.25	5.125	6.50	0.10	2.10
F51A V	Shroud	4	11.00	5.875	14.25	0.53	9.40	Carton	5.25	5.125	6.50	0.10	2.10

Levers

F10 V	Shroud	4	11.00	7.375	14.25	0.67	11.40	Carton	5.25	6.50	6.50	0.13	2.60
F40 V	Shroud	4	11.00	7.375	14.25	0.67	11.40	Carton	5.25	6.50	6.50	0.13	2.60
F51A V	Shroud	4	11.00	7.375	14.25	0.67	11.40	Carton	5.25	6.50	6.50	0.13	2.60

DEXTER J SERIES GRADE 3 LOCKS

JD60 V	Box	4	7.50	5.90	17.50	0.45	9.80	Carton	6.80	5.00	2.60	0.05	1.20
JD62 V	Box	4	7.50	5.90	17.50	0.45	9.80	Carton	6.80	5.00	2.60	0.05	1.40
JH60 V	Box	1	18.00	8.00	5.60	0.47	5.80	Carton	17.20	7.50	5.20	0.39	5.00
J54 V	Box	4	7.50	8.60	18.00	0.67	10.20	Carton	6.90	7.70	2.70	0.08	1.20
J40 V	Box	4	7.50	8.60	18.00	0.67	9.40	Carton	6.90	7.70	2.70	0.08	1.00
J10 V	Box	4	7.50	8.60	18.00	0.67	9.40	Carton	6.90	7.70	2.70	0.08	1.00
J170 V	Box	4	7.80	5.40	12.00	0.29	1.80	Carton	6.90	7.70	2.70	0.08	0.20
J54 V	Box	4	7.50	8.60	18.00	0.67	10.20	Carton	6.90	7.70	2.70	0.08	1.20
J40 V	Box	4	7.50	8.60	18.00	0.67	9.40	Carton	6.90	7.70	2.70	0.08	1.00

NOTE: Retail products must be ordered in full case quantities.

PORTABLE SECURITY

Product	Master Carton							Inner Pack					Individual Selling Unit (ea.)					
	PKG. TYPE	CASE QTY	HT. (IN.)	WID. (IN.)	DPT. (IN.)	CUBIC FT.	WT. (LBS.)	PKG. TYPE	INNER CASE QTY	HT. (IN.)	WID. (IN.)	DPT. (IN.)	PKG. TYPE	HT. (IN.)	WID. (IN.)	DPT. (IN.)	CUBIC FT.	WT. (LBS.)
Padlock 23 Series Brass K-N-K Cyl 1-1/2" Shackle, KD	Box	24	7.17	10.39	8.70	0.37	26.49	Box	6	2.76	7.76	4.53	Box	4.13	2.31	1.00	0.006	1.10
Padlock 23 Series Brass K-N-K Cyl 2" Shackle, KD	Box	24	7.17	11.34	8.70	0.41	26.49	Box	6	2.76	7.76	5.00	Box	4.63	2.31	1.00	0.006	1.10
Padlock 43 Series Brass K-N-K Cyl 1-1/2" Shackle, KD	Box	24	7.17	10.39	8.70	0.37	28.7	Box	6	2.76	7.76	4.53	Box	4.13	2.31	1.00	0.006	1.21
Padlock 43 Series Brass K-N-K Cyl 2" Shackle, KD	Box	24	7.17	11.34	8.70	0.41	28.7	Box	6	2.76	7.76	5.00	Box	4.63	2.31	1.00	0.006	1.21
Padlock 72 Round Steel K-N-K Cyl 2", KD	Box	18	4.27	17.27	9.79	0.42	54.95	Box	6	3.27	9.29	5.59	Box	4.94	2.81	1.19	0.010	0.85
Covered Laminated Steel Padlock - 2 Pack - KA	Box	18	14.50	9.00	19.25	1.45	24	Display	3	7.10	8.27	5.31	Blister	6.50	7.75	2.00	0.058	1.12
Extra Large "U" Padlock 4" x 11", KD	Box	•	•	•	•	•	•	Display	4	14.00	7.30	8.70	Bulk/Belly-Band	12.50	7.00	1.75	0.089	2.30
Shackle-less Padlock, KD	Box	36	19.25	12.25	20.75	2.83	88	Display	6	8.75	6.50	11.25	Blister	7.75	5.00	2.00	0.045	2.25
Padlock Round Steel, 2" Shackle, KA	Box	18	19.50	7.50	19.75	1.67	36	Box	3	9.00	6.70	6.30	Box	7.50	4.75	1.50	0.031	1.60
Padlock Round Steel, 2" Shackle, KA - 2-Pack	Box	18	19.00	10.00	18.75	2.06	64	Box	3	9.00	8.70	6.30	Box	7.50	7.50	1.50	0.049	3.20
Rekeyable Locking Cable 6' x 5/8" Replaced item 997719)	Box	•	•	•	•	•	•	Display	5	12.75	7.75	17.25	Bulk/Insert Card	12.00	10.00	1.50	0.104	3.00
Double Looped Cable 4' x 3/8" with Covered Weather-proof Padlock	Box	•	•	•	•	•	•	Display	4	9.45	11.40	8.66	Bulk/Insert Card	10.00	8.50	1.50	0.074	1.30
Double Looped Cable 15' x 3/8" with Covered Weather-proof Padlock	Box	•	•	•	•	•	•	Display	4	10.60	12.20	9.40	Bulk/Insert Card	11.00	9.50	1.50	0.091	2.70
Locking Cable 5' x 1/2"	Box	•	•	•	•	•	•	Display	4	12.00	5.10	7.28	Bulk/Insert Card	10.00	3.75	1.25	0.027	1.00
Locking Resettable Combination Cable 5' x 3/8"	Box	•	•	•	•	•	•	Display	4	10.25	5.75	7.25	Bulk/Insert Card	10.00	5.25	1.25	0.038	1.16



PORTABLE SECURITY

Product	Master Carton							Inner Pack					Individual Selling Unit (ea.)					
	PKG. TYPE	CASE QTY	HT. (IN.)	WID. (IN.)	DPT. (IN.)	CUBIC FT.	WT. (LBS.)	PKG. TYPE	INNER CASE QTY	HT. (IN.)	WID. (IN.)	DPT. (IN.)	PKG. TYPE	HT. (IN.)	WID. (IN.)	DPT. (IN.)	CUBIC FT.	WT. (LBS.)
Locking Chain 5' x 5/16" (7mm)	Box	3	11.75	9.25	14.00	*	16.70	Display	3	11.25	9.25	14.00	Blister	13.50	8.25	1.75	*	4.95
Locking Chain 4' x 7/32" (3.5mm)	Box	3	9.75	8.25	10.00	*	7.55	Display	3	9.25	7.75	9.25	Blister	10.50	7.00	1.35	*	2.20
Double Looped Cable 7' x 5/8"	Box	*	*	*	*	*	*	Display	5	11.25	12.00	10.75	Bulk/ Insert Card	10.50	11.50	2.00	0.140	2.70
Double Looped Cable 30' x 3/8"	Box	*	*	*	*	*	*	Display	4	10.50	11.75	10.75	Bulk/ Insert Card	10.50	10.00	3.00	0.182	4.40
Double Looped Cable 15' x 3/8"	Box	*	*	*	*	*	*	Display	4	12.38	9.79	7.88	Bulk/ Insert Card	9.00	9.00	2.00	0.094	2.26
Double Looped Cable 7' x 3/8"	Box	*	*	*	*	*	*	Display	4	13.91	6.20	5.75	Bulk/ Insert Card	12.00	7.00	1.00	0.049	1.21
Double Looped Cable 4' x 3/8"	Box	*	*	*	*	*	*	Display	4	11.75	6.20	5.25	Bulk/ Belly- Band	10.50	5.50	1.00	0.033	0.60
Cinch Ring Security Chain 3' 3" - (No lock)	Box	2	7.50	4.25	7.25	0.13	14	Box	1	3.60	3.85	3.50	Bulk/ Hang Tag	22.50	3.50	2.00	0.091	6.85
Cinch Ring Security Chain 5' - (No Lock)	Box	2	7.75	4.25	7.25	0.14	20	Box	1	3.60	3.85	3.50	Bulk/ Hang Tag	33.00	3.50	2.00	0.134	10.60
Vehicle Hasp	Box	18	11.50	17.25	26.00	2.98	59	Display	3	10.50	8.25	8.25	Blister	9.75	5.25	2.25	0.067	2.95
Flexible Dbl-Hinged Hasp 7 3/4" x 1-3/4"	Box	36	22.50	14.50	17.50	3.30	49	Display	6	10.50	5.25	14.00	Blister	9.50	3.75	1.75	0.036	1.05
Repl Accessory Service Repair Kit, SFIC, KNK, Specialty	Box	6	14.75	18.25	11.25	1.75	63.7	Box	1	2.38	18.25	11.25	Box	*	*	*	*	*



This page intentionally left blank

About Allegion

Allegion (NYSE: ALLE) is a global pioneer in seamless access. We keep people and their assets safe, wherever they are, bringing together simple solutions, convenient access and advanced technology.

For more, visit www.allegion.ca

KRYPTONITE ■ LCN ■  ■ STEELCRAFT ■ VON DUPRIN

The Bluetooth word mark and logos are registered trademarks owned by Bluetooth SIG, Inc. and is licensed for use by Schlage. Android, Google Play, and the Google Play logo are trademarks of Google, Inc. Apple Watch, iPhone, and HomeKit are registered trademarks of Apple Inc. Amazon, Alexa, and all related logos are trademarks of Amazon.com, Inc. or its affiliates.