

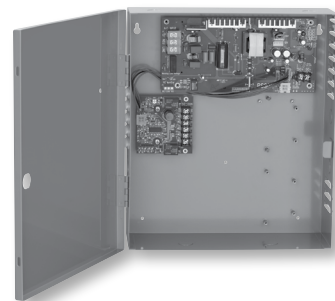

Electronic security price book 14

Effective March 1, 2024





United States Customer Care

Our Customer Care Representatives are available for questions or assistance.

877-671-7011

Customer service

- Press 1
- support@allegion.com

Technical product support

Schlage Electronic Locks and System Components

- Electronic_Lock_TechProdSupport@allegion.com

Readers and Credentials

- Readers_Credentials_Biometrics_TechProdSupport@allegion.com

Von Duprin Electronics

- 1-866-422-5547
- Exits_TechProdSupport@allegion.com

Engage Tech Support

- Engage.Tech.Prod.Support@allegion.com

Isonas Tech Support

- Isonas.Tech.Prod.Support@allegion.com

For new projects or to locate an authorized distributor

- Press 3

For general sales questions, pre-printed cards, CardTrax accounts

- ElectronicInsideSales@allegion.com

Canada Customer Care

Our Customer Care Representatives are available for questions or assistance.

- 800-900-4734
- Canada.CustomerService@allegion.com

Technical product support

- Canada.TechServices@allegion.com

Placing orders

You can place orders with Allegion via the fax number or email listed below:

- 1-800-209-4734
- Canada.Orders.Service@allegion.com

Canada Administrative Office

1076 Lakeshore Road East
 East Mississauga, Ontario L5E 1E4
allegion.ca

United States Request for quote

Carolinas

(North Carolina, South Carolina, Virginia)
Carolinas.Quotes@allegion.com

Central

(Illinois, Iowa, Kansas, Missouri, Nebraska)
Central.Quotes@allegion.com

Chicago

(Northern Illinois, Wisconsin)
Chicago.Quotes@allegion.com

Florida

Florida.Quotes@allegion.com

Metro New York

(Metro New York, Northern New Jersey)
Metro.Quotes@allegion.com

Michigan

Michigan.Quotes@allegion.com

Mid Atlantic North

(New York, Western Pennsylvania)
Mid.Atlantic.North.Quotes@allegion.com

Mid Atlantic South

(Delaware, Eastern Pennsylvania, Maryland, Northern Virginia, Southern New Jersey, Washington DC)
Mid.Atlantic.South.Quotes@allegion.com

Midwest

(Indiana, Kentucky, Ohio, West Virginia)
Midwest.Quotes@allegion.com

Mountain States

(Colorado, Idaho, Montana, Nevada, Utah, Wyoming)
Mtn.States.Quotes@allegion.com

New England

(Connecticut, Maine, Massachusetts, New Hampshire, Rhode Island, Vermont)
NewEngland.Quotes@allegion.com

North Central

(Minnesota, North Dakota, South Dakota)
NorthCentral.Quotes@allegion.com

Northern California

NoCal.Quotes@allegion.com

Northwest

(Alaska, Oregon, Washington)
Northwest.Quotes@allegion.com

South

(Alabama, Georgia, Louisiana, Mississippi, Tennessee)
South.Quotes@allegion.com

Southern California

(Southern California, Hawaii)
SoCal.Quotes@allegion.com

Southwest

(Arizona, New Mexico)
Southwest.Quotes@allegion.com

Texas

(Arkansas, Texas, Oklahoma)
Texas.Quotes@allegion.com

Canada Request for quote

(All Regions/Provinces)
Quote.Request.Canada@allegion.com

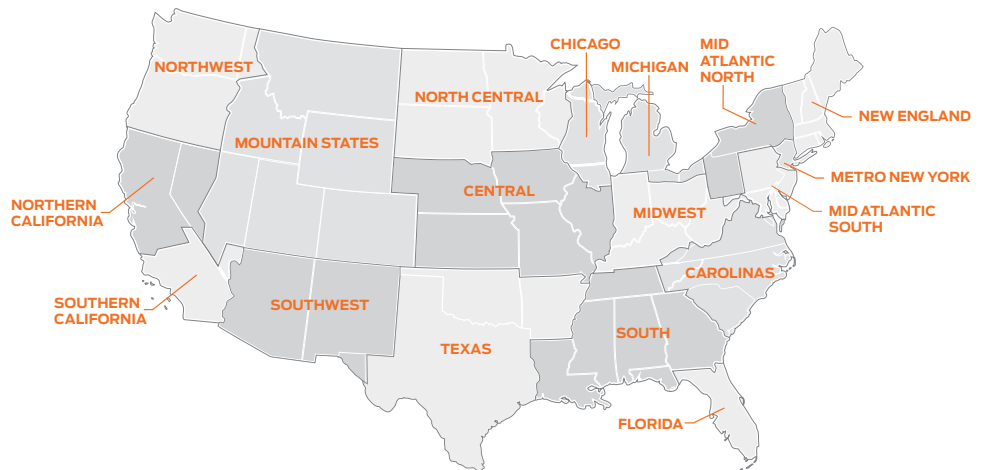



Contents

Doing business with Allegion..... 4

- Keyway and cylinder policies 4
- Distribution policy and finishes 10
- Allegion Solutions overview 11

Credentials13

- How to order14
- Schlage Mobile Bluetooth® credentials ...16
- Schlage Smart Card credentials.....16
- Schlage Proximity credentials.....19
- Schlage Magnetic stripe credentials19
- Services20

Networked readers 24

- Overview 24
- How to order26
- Multi-technology readers..... 27
- Magnetic stripe readers..... 27
- Contactless Smart Card readers 27
- Proximity readers 27
- Parts and accessories.....28
- OEM Module30

Reader controllers..... 35

- RC Pure IP Multi-technology reader controller.....36
- CTE ENGAGE™ Single door controller 37
- CT5000 Offline controller38
- WRI400 Outdoor wireless reader interface.....39

Multi-family electronic locks 40

- Schlage Control® Mobile enabled smart interconnect locks41
- Schlage Control® Mobile enabled smart deadbolt44
- Schlage Control® Top sellers.....46

ENGAGE™ Technology locks 47

- LE Mobile Enabled Wireless Lock..... 47
- Overview 47
- How to order 49
- Functions51
- Styles 52
- Configure a product 56
- Parts 62
- Accessories 67

NDE Mobile Enabled Wireless Lock..... 68

- Overview 68
- How to order 69
- Functions 71
- Styles72
- Configure a product 73
- Parts 79

AD Series..... 86

- AD Series Networked locks86
- Overview 86
- How to order 87
- Functions 89
- Readers 90
- Styles91
- Configure a product 92
- AD-300 Networked hardwired101
- AD-302 Networked hardwired (FIPS 201-2 Compliant)110
- AD-400 Networked wireless116
- AD-402 Networked wireless (FIPS 201-2 Compliant)125
- AD-993 Non-functioning dummy trim 131
- Networked accessories.....133

AD Series Standalone locks 139

- How to order 140
- AD-201/AD-302/AD-402 Overview..... 141
- Functions142
- Readers 143
- Styles 144
- Configure a product 145
- AD-200 Standalone; Rights on locks152
- AD-201 Standalone (FIPS Compliant); Rights on lock 161
- AD-250 Standalone; Rights on card167
- AD-993 Non-functioning dummy trim173
- Standalone accessories175
- AD Series Parts..... 179

CO Series Standalone198

- How to order 199
- Functions.....201
- Readers.....202
- Styles.....203
- Configure a product..... 204
- CO-100 Standalone.....211
- CO-200 Standalone217
- CO-220 Standalone223
- CO-250 Standalone229
- CO-993DT Non-functioning dummy exit trim235
- CT5000 Offline controller237
- CO Series Accessories239
- CO Series Parts 241

Electromagnetic locks.....258

- M490 Max security259
- M450 High security 260
- M420 Traffic control series 261
- M490DE Delayed egress series.....262
- M390RFK Retrofit lock263
- Filler plates and angle brackets264

- M490G Gate lock265
- 320M Mini mortise mount265
- GF3000 Shear lock mortise series 266
- GF-3000 Shear lock surface series.....267
- Electromagnetic lock parts 268

Power supplies.....270

- Power supplies and option boards271

Von Duprin Access control products272

- PS914 Power supplies 273
- Delayed exit system..... 273
- Electric power transfer..... 273
- Remote Undogging (RU) and Remote Monitoring (RM) 273
- 4200/5100 Series Electric strikes 274
- 6100/6200 Series Electric strikes 275
- 6300/6400 Series Electric strikes276

System accessories 277

- 8200 Series Consoles278
- 800 Series Remote and local monitoring stations.....278
- 672 TouchBar279
- 692 SmartBar..... 280
- 672 TouchBar/692 SmartBar Parts..... 281
- 600 Series Heavy duty pushbuttons ...282
- 600 Series Heavy duty pushbutton parts.....283
- 700 Series Entry level pushbutton284
- 650 Series Heavy duty keyswitches285
- 650 Series Heavy duty keyswitch parts 286
- FSS1 High security door position monitor.....287
- Door position switches.....287
- Door cords.....287
- Electronic horns..... 288
- Scanners/PIRs..... 288
- 740 Series Emergency break glass 288
- 660 Series Surface mini box..... 288
- 442S Series Cabinet lock 289
- PB405/PB405S PowerBolts 289

Miscellaneous..... 290

- Merchandising aids 291
- Agency listings292
- Door and frame handing chart.....294
- System design guide.....295
- Master key system summary 296
- Wiring diagrams.....303
- BAA Order transmittal cover letter 306





Policies and documents

The purchase of Allegion products is governed by the Allegion Authorized Seller Program. For program terms and conditions, and other program details, please visit:

USA www.allegion.com/AuthorizedSeller

CAN www.allegion.ca/policies

For Warranty information, visit us.allegion.com/warranty or contact Customer Service at:

USA 877-671-7011

CAN 800-900-4734

Keyway definitions

Open keyways

Everest and Everest 29 Open (C and S Key Sections)

Everest and Everest 29 Open (C & S keyways) include non-Primus products with Everest C and Everest 29 S keyways and key sections. Schlage only sells Everest and Everest 29 Open products to commercial security professionals. Commercial security professionals purchasing Everest and Everest 29 Open products from Schlage are permitted to stock and to originate or duplicate keys without signature verification.

Purchasers of Everest and Everest 29 open (C & S) are permitted to resell the products in accordance with their distribution agreement to end users and to other commercial security dealers who have a professional locksmith on staff but are expressly prohibited from selling to:

- i) Any residential retail outlet.
- ii) Any individual or entity purchasing or selling products through any method of auction.

Standard Classic (Obverse) Key Sections - no restriction

Standard keyways are Classic (Obverse) C, CE, E, EF, F, FG, G, H, J, K, L.

Restricted keyways

Everest B, Everest 29 R

All Everest and Everest 29 SFIC (B and R Families) keyways are restricted.

Everest D, Everest 29 T

All Everest D and Everest 29 T keyways are restricted.

Quad, Numbered (“Paracentric”) and Reverse Keyway Family Policy

These keyway families do not require a letter of authorization from the end-user and not available for new master key systems. Orders can be submitted for plugs, 0-bitted and 1-bitted, master keyed, and key blanks; keyed random is not available.

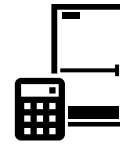

Online ordering is available through Overtur™ Estimate and Order (OEO)

OEO offers much more than placing online orders including:

- Provides net price for direct customers and list price for indirect customers, integrator partners and end-users
- Online Ordering for direct customers
- Automated price updates
- Ability to export price lists and cross-reference guides in Excel
- Configuration and configuration reports, including e-lock configurations
- Request a quote or quote revision from an estimate
- Keying Guide
- Library pre-built hardware sets

How to get it:

1. Login or register at <http://360portal.allegion.com>
2. Find the Estimate and Order Icon and follow the instructions to request access
3. The Online Ordering team will begin working on your access with your Allegion Sales Representative

Traditional ordering methods

United States

✉ Allegion_Orders@allegion.com

☎ 1-800-248-1460

Canada

✉ Canada.Orders.Service@allegion.com

☎ 1-800-209-4734

Training and Troubleshooting



Scan the QR Code to access our resource center or visit

<https://support.oeo.allegion.com/hc/en-us>

Questions or issues should be reported to Online.Ordering.Support@allegion.com for escalation

RESTRICTED KEYWAY POLICY

Everest B, Everest 29 R - All Everest and Everest 29 SFIC (B and R Families) keyways are restricted.

When ordering a new keying system, include the following:

- Job (end-user) name, city, state and zip code.
- Letter of Authorization (LOA) – Authorized ship-to address for key blanks, cores and cut keys on end-user’s official stationery. See page 302 for sample letter of authorization.
- Numerically defined specifications for expansion of all branches of the key system.

The factory will assign a “facility code” which will appear on all keys and blanks for this job. When ordering additions to an existing keying system, include the following:

- Job (end-user) name, city, state and zip code.
- Facility code previously assigned by Schlage and stamped on all existing keys and blanks.
- Registry number of the keying system as established by Schlage.
- Letter of authorization on end-user’s official stationery is required when:
 - End-user places order with new dealer.
 - Order is to be drop shipped to a different ship-to address than originally authorized by the end-user. See page 302 for sample letter of authorization.

Bitting list (transcript) orders require a letter of authorization on the end-user’s official stationery. Prevailing prices apply.

Everest D, Everest 29 T - All Everest D and Everest 29 T keyways are restricted.

When ordering a new keying system, include the following:

- Job (end-user) name, city, state and zip code.
- Letter of Authorization (LOA) – Authorized ship-to address for all products on end-user’s official stationery. See page 302 for sample letter of authorization.
- Numerically defined specifications for expansion of all branches of the key system.

The factory will assign a “facility code” which will appear on all keys and blanks for this job. When ordering additions to an existing keying system, include the following:

- Job (end-user) name, city, state and zip code.
- Facility code previously assigned by Schlage and stamped on all existing keys and blanks.
- Registry number of the keying system as established by Schlage.
- Letter of authorization on end-user’s official stationery is required when:
 - End-user places order with new dealer.
 - Order is to be drop shipped to a different ship-to address than originally authorized by the end-user. See page 302 for sample letter of authorization.

Quad, Numbered (“Paracentric”) and Reverse Keyway Family Policy

A letter of authorization from the end-user is required for all orders for restricted keyway plugs, 0-bitted and 1-bitted products and all key blanks. Restricted keyway products are not available keyed random. The letter of authorization must include the address in which the materials will be shipped. Keyway or keyway family must be referenced in the letter. Letters must be dated and signed by the end user. Letters dated more than 6 months prior to the order submission date will not be accepted. Letters for projects that are ongoing may be older than six months if effective dates are referenced in the letter. With the exception of the signature, all other information must be typed.

Allowable End User Authorizations for Restricted Keyways:

The end user can authorize a dealer or distributor to order and inventory products if they so choose. This authorization requires the submission of a fully completed “Letter of Authorization” or “Signature Card”, depending on the product type requirements, by the end user to Schlage.

CONSTRUCTION CORE PROGRAM POLICY

Full size and small format construction cores will be invoiced under standard payment terms. Credit for these cores, less the handling charge, will be issued upon their return to the factory. Please contact customer service for return authorization. Customers may not deduct payment for construction cores prior to completion of their authorized return.

CONTROL KEYS FOR INTERCHANGEABLE CORES

A single control key will be added to orders containing interchangeable cores where a new masterkey system, master key system expansions requiring a different control key and all construction core orders are placed and does not include a control key on the purchase order. Construction core orders will include both a control and user key.

PRIMUS®/ PRIMUS XP SALES POLICY

Primus High Security cylinder products manufactured by the Schlage Lock Company are offered for sale through specific channels of distribution, based on stocking requirements and security levels. Possession of this price book or any other Schlage price book does not constitute “the right to purchase” Primus products.

Important: In stocking levels where purchase agreements are required, a fully executed purchase agreement, including initial minimum inventory order, must be in place before any Primus products may be quoted or purchased. Contact your RSO Consultant for specific details.

The prices contained herein apply to Primus Levels 1 through 9 with respect to the actual product. Availability of product is subject to additional conditions as follows:

Classic Keyways

PRIMUS/PRIMUS XP LEVEL 1: For retail locksmiths and Schlage dealers. Standard nationwide side biting by keyway. Stocking level requires a separate Primus/Primus XP agreement. Initial inventory commitment required for distributors but not for participating locksmiths. Obverse keyways only. HP, JP and LP section keys are not available.

PRIMUS LEVEL 1 PLUS: For retail locksmiths. A side biting is assigned on a nationwide exclusive basis to a specific Schlage wholesale distributor. Stocking level which requires a separate Primus purchase agreement and an initial minimum inventory purchase by the wholesaler and the locksmith. Obverse keyways only. HP, JP and LP section keys are not available. Cylinders are always furnished less key blanks (LKB).

PRIMUS XP LEVEL 1 PLUS: For retail locksmiths. An exclusive side biting is assigned to dealer within the first three digits of the dealer physical location zip-code. Distribution through direct Schlage dealers. Stocking level which requires a separate Primus purchase agreement and an initial minimum inventory purchase. Obverse keyways only. Cylinders can be ordered LKB, KD, KA or MK.

PRIMUS/PRIMUS XP LEVEL 2: For Schlage dealers and large commercial locksmith businesses. Exclusive side biting is assigned to dealer by time zone. Distribution through direct Schlage dealers. Stocking level which requires a separate Primus purchase agreement and an initial minimum inventory purchase. Obverse keyways only.

PRIMUS/PRIMUS XP LEVEL 3: End user level not stocked by dealers. Key systems are assigned a side biting exclusive within 2-digit zip code (Level 3G) for orders of 60 - 1,999 Primus cylinders. Orders of fewer than 60 Primus cylinders are randomly assigned a side biting from a small nationwide pool of side bittings (Level 3U). Distribution through Schlage dealers and Schlage wholesale distributors. Obverse and Quad keyways only.

PRIMUS/PRIMUS XP LEVEL 4: End user level not stocked by dealers. Key systems are assigned a side biting exclusive within a time zone (Level 4Z) for orders of 2,000 - 3,999 Primus cylinders. A nationwide exclusive side biting (Level 4N) is assigned to key systems of 4,000 or more Primus cylinders. This exclusivity can be purchased for a separate fee for smaller quantities of cylinders. This price book does not contain the fee schedule. Contact your RSO Consultant for specific information. Distribution through Schlage dealers and Schlage wholesale distributors. Obverse and Quad keyways only.

Everest® Keyways

PRIMUS LEVEL 7: For retail locksmiths. Side biting is assigned on a nationwide exclusive basis to a specific Schlage wholesale distributor. Stocking level which requires a separate Primus purchase agreement and an initial minimum inventory purchase by the Schlage wholesaler and the locksmith. Same as Level 1 PLUS above, but with Everest S Family keyways only.

PRIMUS XP LEVEL 7: For retail locksmiths. An exclusive side biting is assigned to dealer within the first three digits of the dealer physical location zip-code. Distribution through direct Schlage dealers. Stocking level which requires a separate Primus purchase agreement and an initial minimum inventory purchase. All Everest 29 key sections. Cylinders can be ordered MK, KA, KD or LKB.

PRIMUS/PRIMUS XP LEVEL 8: For Schlage dealers and large commercial locksmith businesses. Exclusive side biting is assigned to dealer by time zone. Distribution through direct Schlage dealers. Stocking level which requires a separate Primus purchase agreement and an initial minimum inventory purchase. Equivalent to Level 2 above, but with Everest S Family keyways only.

PRIMUS/PRIMUS XP LEVEL 9: End user level not stocked by dealers. Key systems are assigned varying degrees of geographically exclusive side bittings based on a sliding scale of purchase commitment or separate fees. This price book does not contain the fee schedule. Contact your RSO Consultant for specific information. Distribution through Schlage dealers and Schlage wholesale distributors. Level 9U, 9G, 9Z, and 9N are equivalent to Levels 3U, 3G, 4Z, and 4N above, but with Everest S and T Family keyways.

The following side bit milling exclusivity criteria apply to both levels 3, 4 and 9:

- 1- 60 cylinders-Random assignment
- 61-1999 cylinders-First two digits of zip-code
- 2000-3999 cylinders-Time-Zone Exclusivity (also available for \$10,000 fee for an organization who would like this exclusivity and doesn't meet cylinders quantity requirement).
- 4000 + cylinders-Nation Wide Exclusivity.(also available for \$40,000 fee for an organization who would like this exclusivity and doesn't meet cylinders quantity requirement).



Important ordering information

See [Forms and Examples](#): Primus and Everest 29 Primus Ordering Checklist for a checklist of information required to process a Primus order. Note that, for security reasons, all end user Primus levels (Level 3, 4 and 9) require a Facesheet (MS-E120) bearing an original signature. Opening orders for end user Primus levels also require a Signature Card (MS-E130) bearing original signatures. Facesheets and signature cards are used to authenticate the end user request for product, therefore orders received without the correct supporting documents (or without original signatures) are subject to delays or cancellations. Blank Facesheets and Signature Cards are included in the [Forms and Examples](#) section of this price book for your reference. Additionally, electronic version of these forms are available at allegion.com/us.

The Schlage Lock Company reserves the right to make changes in designs and specifications, to make additions or improvements on its products, or to discontinue products without incurring any obligation. The Schlage Lock Company is not responsible for any modification, addition, or alteration to our products by others.

INVENTORY COMMITMENT REQUIREMENTS - COMMERCIAL LOCKSMITHS LEVELS			
Primus XP		Everest 29 Primus XP	
Level 1	None	N/A	N/A
Level 1+	\$7,500	Level 7 XP	\$7,500
Level 2	25,000	Level 8	\$25,000

- CREENTIALS
- READERS
- READER CONTROLLERS
- MULTI-FAMILY
- ENGAGE
- AD SERIES
- CO SERIES
- ELECTROMAGNETIC LOCKS
- POWER SUPPLIES
- VON DUPRIN ACCESS CONTROL
- SYSTEM ACC
- MISC

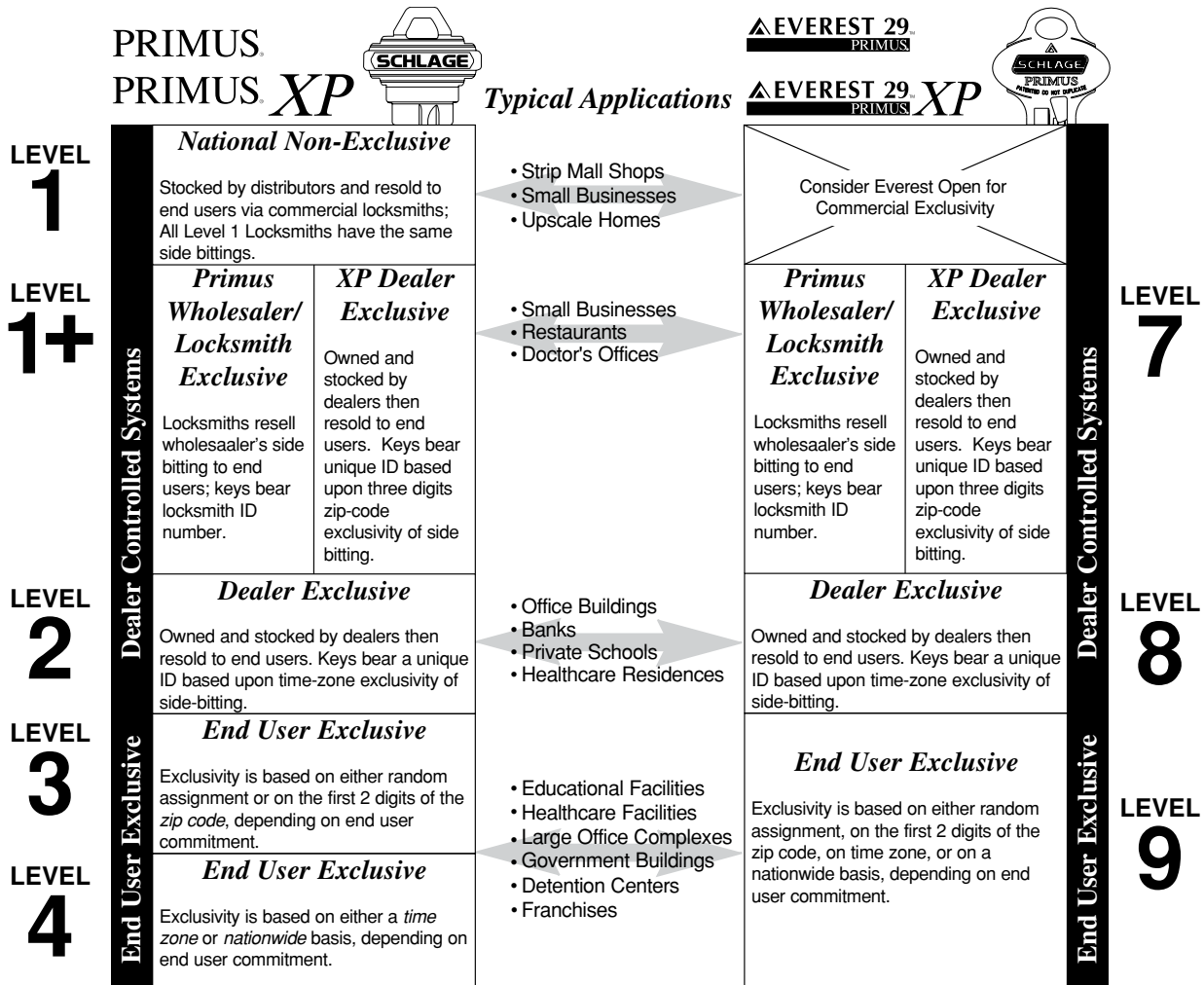

Electronic validation from Schlage¹

Electronic validation (e-validation) is an online system for the use of the end user to create electronic authorizations replacing the letter of authorization (LOA) and Primus Facesheet processes. This online validation system is designed to ease the burden of an end user providing authorizations for ordering restricted key and cylinder products on their behalf. Through this system, the end user can register for an online account with Schlage that will allow them to manage their shipping addresses, shipping contacts and additional authorized users for their restricted products. Through this system, they can then generate an electronic Facesheet that they can provide to the distributor of their choice to allow an order for restricted products to proceed. Enrolling in and using this feature will reduce the overall time for an order to be processed from the time that the end user has determined the need for product. The electronic Facesheet provided by the e-validation system can be faxed or emailed along with a distributors order reducing the time and energy required for original copies of Facesheets previously required. The system is for both new and existing restricted key system owners. For new restricted systems, a registration process will provide the ability to create the initiating Facesheet for the project.

- Products/key systems eligible for e-validation:
- Everest – B and D restricted family of keyways
 - Everest 29 – R and T restricted family of keyways
 - Primus – All keyway families that include the Primus feature
 - Primus XP – All keyway families that include the Primus XP feature

E-validation can be accessed at the following web address: <https://mycredentials.allegion.com>

¹ Does not apply to Canada.



MASTER KEY SHIPMENT POLICY

Keyway Family of Master Key System

- Classic Restricted (Numbered, Quad and Reverse)
- Classic Primus (Obverse and Quad)
- Everest Restricted (B and D Family)
- Everest 29 Restricted (R and T Family)
- Everest Primus (C and D Family)
- Everest 29 Primus and Primus XP (S and T Family)
- Classic Open (Obverse)
- Everest Open (C Family)
- Everest 29 Open (S Family)

Standard Method of Shipment¹

- 2-Day Air
 - Tracking number is assigned to shipment
 - Recipient's signature is required upon delivery

¹ Does not apply to Canada.

All goods are shipped F.O.B. factory and become the customer's property when they pass into the hands of the transportation company. Schlage reserves the right to use our choice of carrier.

Schlage Default Keyways

Schlage Commercial products (excluding Portable Security)

- Default keyway is Everest 29 S123
- For other optional keyways, please specify

Schlage Electronics

- Default keyway is Everest 29 S123
- For other optional keyways, please specify

Portable Security - Kryptonite:

- Default to C keyway KD
- For made to order products, please specify the keying and keyway

Schlage Residential: (F, B60, J-Lock)

- Default keyway is C

DISTRIBUTION FUNCTION AND LOCATION POLICY

The Schlage customer relationship includes the nonexclusive area of primary sales responsibility and the channel of distribution assigned by Schlage. It is vital to our success and for the effective management of the distribution of our products that the Schlage customer relationship, once it is satisfactorily established between us, should not be changed without our approval. Therefore, after selection by Schlage as a distributor of one or more of Schlage products, a customer should continue to perform that distribution function from the location of its business at the place or places utilized at the time of selection. A customer should not change its Schlage distribution function or establish a different or additional location without the prior written consent of Schlage.

Schlage reserves the right to discontinue, after appropriate notice, sale of its products to any customer which refuses to adhere to this policy. Schlage also reserves the right to change, in its sole discretion, the number and locations of the distributors authorized to distribute its products in any area. This determination will be based upon, among other considerations, the success or failure in developing the market for Schlage products.

Hardware Finishes

Schlage Lock finishes are durable, top quality finishes obtained by the careful processing of solid brass, bronze, stainless steel or other materials. Where required, a protective clear coating is applied and cured under high temperature. It is important that climatic conditions and usage be taken under consideration when selecting finishes. This is especially true in areas subjected to strong corrosive vapors, humid climate or sea air which, in a short time, may have a damaging effect on metal finishes. The longevity and preservation of the finish appearance is determined by base metal and finishing process. Clear protective coating or other organic finishing applications may require different methods of cleaning and care. As an example, non-clear coated finishes should not be cleaned with soaps or any solvents; organically coated surfaces should periodically be cleaned with a mild, nonabrasive soap and buffed lightly with a clean cloth. The type of base metal and finishing techniques must be considered when applying any cleaning or preservative method. Contact the Schlage Technical Services Department for further information on the care of finished hardware.

In some instances, for customer convenience, the most appropriate BHMA finish symbols are used to indicate similarity of appearance, regardless of base metal of finishing process. A, CS, ND, F, FA, H, S, S200 Series and Dexter by Schlage levers are zinc-based material and are plated to match finishes indicated. L Series will utilize a brass material for 612 and 613 finishes. Finishes of latches, strikes, cylinders/cores, and visible mounting screws, though similar in appearance, may differ from the finish of the trim. Finish numbers in the 600 Series are the BHMA (Builders Hardware Manufacturers Association) industry standard.

COMMERCIAL FINISH CODES AND DESCRIPTIONS

The nearest old U.S. equivalent code designations are shown in parenthesis ().

Symbol	Description	Symbol	Description
605 (US3)	Bright Brass, Clear Coated	622 (US19)	Matte Black, Coated
606 (US4)	Satin Brass, Clear Coated	625 (US26)	Bright Chromium Plated, No Coating
609 (US5)	Antique Brass, Satin Brass, Blackened Satin Relieved, Clear Coated	626 (US26D)	Satin Chromium Plated, No Coating
612 (US10)	Satin Bronze, Clear Coated	629 (US32)	Bright Stainless Steel, No Coating
613 ¹ (US10B)	Oil Rubbed Bronze, Oxidized Satin Bronze, Oil Rubbed, No Coating	630 (US32D)	Satin Stainless Steel, No Coating
619 (US15)	Satin Nickel, Satin Nickel Plated, Clear Coated	643e	Aged Bronze, Clear Coated

¹ Oil rubbed bronze (613) is considered a category "B" finish by ANSI/BHMA and will vary in color when applied to different alloys and forms of base material. 613 will also vary from production lot and additionally from one manufacturer to another. Oil rubbed bronze will wear off over time due to the "rubbed" finishing method that has no protective coating or plating.

For more than 100 years Allegion brands have been providing innovative access control solutions. We are at the forefront of access control innovation, including contactless smart credentials, wireless security products.

Allegion electronic security offers the most extensive range of access control and security management solution on the market today. This comprehensive line of products allow you to build a complete access control system from the ground up. For facilities with existing access control systems, the open architecture design of Allegion electronic security products facilitates easy integration into your existing system. Because Allegion understands that your needs will evolve over time, Allegion also provides the opportunity for an easy migration path as technology advances.

At Allegion, we understand that each facility has unique security requirements. Our extensive line of products, flexible options and ability to adapt to your existing environment make it easy to find a solution that will fit your security needs... whatever they may be.

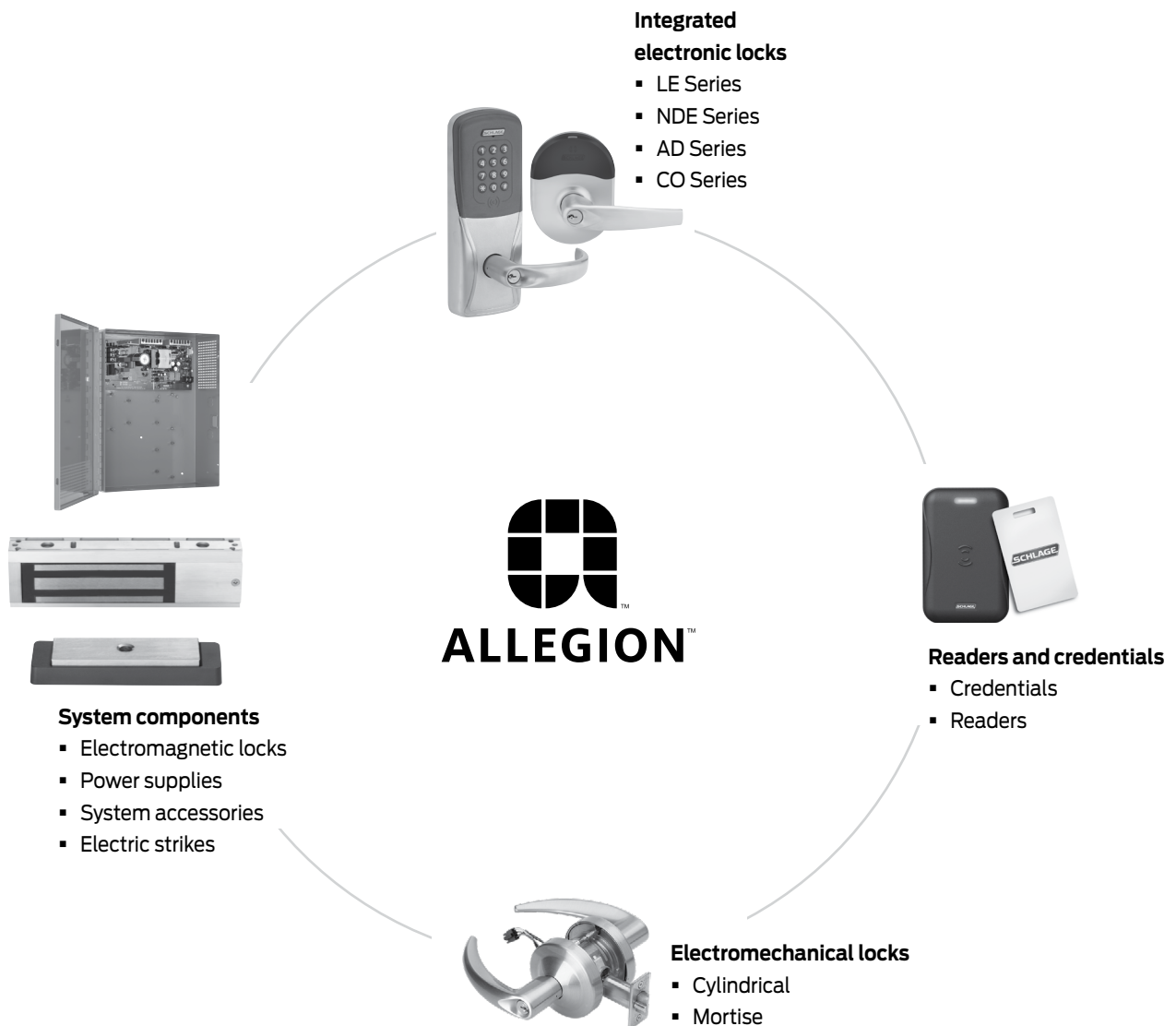



Allegion offers comprehensive security solutions for each facility. To help you identify which solution is right for your facility, here are some reader technologies with their compatible credential technologies. Allegion readers and credentials are designed on an open architecture platform. For more details on compatibility, please refer to the data sheets.

Credential compatibility					
PIN	Magnetic stripe (1,2,3 Track)	Proximity Card (125 kHz)	Smart Card (13.56 MHz)	FIPS 201-2 Compliant	Mobile Credentials (NFC, BLE)

LEB/NDEB Readers					
Multi-technology reader			■	■	■
AD Series Readers					
KP Keypad reader	■				
MGK (Insert) or MSK (Swipe) Magnetic stripe + keypad reader	■	■			
MG (Insert) or MS (Swipe) Magnetic stripe reader		■			
MTK Multi-technology + keypad reader	■		■	■	
MT Multi-technology reader			■	■	
FMK Multi-technology FIPS 201-2 Compliant reader	■		■	■	■
CO Series Readers					
KP Keypad reader	■				
MSK (Swipe) Magnetic stripe + keypad reader	■	■			
MS (Swipe) Magnetic stripe + reader		■			
PRK Proximity + keypad reader	■		■		
PR Proximity reader			■		
Networked Readers					
PR10 Proximity reader - Mini mullion			■		
SM10 Contactless smart reader - Mini mullion				■	
MT11 Multi-technology reader - Mullion			■	■	■
MT15 Multi-technology reader - Wall mount			■	■	■
MTK15 Multi-technology reader with Keypad - Wall mount	■		■	■	■
MT11B Multi-technology reader - Mullion			■	■	■
MTB15 Multi-technology reader - Wall mount			■	■	■
MTKB15 Multi-technology reader with Keypad - Wall mount	■		■	■	■
MTMS15 Multi-technology magnetic stripe reader - Wall mount		■	■	■	■
MTMSK15 Multi-technology magnetic stripe reader with keypad - Wall mount	■	■	■	■	■
SERIII-W Scramble keypad	■				
SERII-WB Scramble keypad	■				
SEKPDMWG Electronic keypad - Mullion mount	■				
SEKPDWG Electronic keypad	■				
SEKPD8B Electronic keypad	■				
Readers and Controllers					
RC11 - Multi-technology IP reader-controller - Mullion			■	■	■
RC15 - Multi-technology IP reader-controller - Wall mount			■	■	■
RCK15 - Multi-technology IP reader-controller with keypad - Wall mount	■		■	■	■

Contents

- Credentials | Overview..... 13**
 - Credential order template..... 15
- Credentials | Mobile 16**
 - Schlage Mobile Access via ENGAGE™ 16
- Credentials | Smart 16**
 - Schlage MIFARE® DESFire® EV3 technology 16
 - Schlage MIFARE® DESFire® EV1 technology 16
 - Discontinued MIFARE® DESFire® credentials..... 17
 - Schlage MIFARE Classic® 18
 - Construction mode credentials..... 18
- Credentials | Proximity 19**
 - Schlage Proximity credentials comparison guide 19
- Credentials | Magnetic stripe..... 19**
- Credentials | Services 20**
 - Slot punch options 20
 - Encoding fee..... 20
 - Custom artwork..... 20
 - Schlage custom encryption key service..... 20
 - Cross reference sheet 20
- Credentials | Options 22**
 - Print scheme options..... 22
- Credentials | CardTrax™ 23**
 - Credential sequencing service..... 23

Customer service	Technical support	Inside sales
<ul style="list-style-type: none"> ▪ Order status ▪ Credit returns of non-defective products ▪ General sales questions 	<ul style="list-style-type: none"> ▪ Technical questions/issues ▪ Returns of defective products ▪ Repairs 	<ul style="list-style-type: none"> ▪ General sales questions ▪ Custom Artwork credentials ▪ CardTrax™ accounts
USA Email Requests to: Sales Support Contact information on Page 2. CAN Canada.CustomerService @allegion.com	USA Readers_Credentials_Biometrics_ TechProdSupport@allegion.com CAN Canada.TechServices @allegion.com	USA ElectronicInsideSales@allegion.com CAN Canada.CustomerService @allegion.com

1) Model number

Please reference pages 16-20 to pick your credential model number to assure you receive the correct technology, form factor and memory size. Below is how the credential model numbers are created but not every combination is available and there are some unique part numbers available.

Sample part number	8	5	4	3	M1
1. Technology					
7 Proximity					
8 DESFire EV1 or EV3					
9 MIFARE Classic					
2. Form factor					
4 Clamshell					
5 ISO Card					
6 Keyfob					
7 Adhesive patch					
8 Combo keyfob					
9 Combo ISO card					
3. Memory					
2 2K byte memory (available in EV1)					
4 4K byte memory (available in EV1, EV3)					
8 8K byte memory (available in EV1)					
4. DESFire EV1 or EV3					
0 DESFire EV1					
3 DESFire EV3 (available only in 4K byte memory)					
5. Other					
M1 Magstripe					
T Thin keyfob					

2) CardTrax™

CardTrax format is a program designed to keep track of credential encoding and badge ID numbers to eliminate confusion in ordering sequential numbering and/or encoding details, and ensures duplicate cards are not issued. Cards will automatically be provided as “next in line” unless otherwise specified. Restricted CardTrax is an exclusive CardTrax Program for qualified end-user customers that provides global encoding protection. **If a CardTrax number is provided on your PO, manual encoding information is not required.** Please reference page 23 for more information on CardTrax.

3) Encoding information^{1,2}

All credentials are encoded with 3 main properties (in order): Bit Format, Facility Code, and Badge ID. Bit Format is the data structure of your credential and determines how many facility codes and unique badge numbers are available to use. Facility Code differentiates your site, or facility, from another site that might be using the same Bit Format and Badge range as yours. Not all Bit Formats use a Facility Code. Badge ID is the unique ID number on the credential that is associated with each user in your access control system.

COMMON BIT FORMATS:

BIT FORMAT	CROSS REFERENCE	FACILITY CODE RANGE	BADGE ID RANGE	PROX	SMART
26A	H10301	0-255	0-65,535	▪	▪
35C ³	CORP1000 identical	0-4,095	0-1,048,575	▪	▪
37X	H10304	0-65,535	0-524,288	▪	▪
40X ³		0-1,023	0-268,435,455		▪

Note: For other supported formats, please contact your Allegion Sales Consultant.

Important encoding notes:

- Every credential order must include directions on how to encode the credential. Most commonly, this includes information like Bit Format, Facility Code (if applicable), and Starting Badge ID Number. Customers using a CardTrax Account to track their credential information can instead provide a CT number on the credential line on the PO. Do not attach additional credential-related documents to the PO. Orders without proper encoding directions will require order clarification and may be delayed. “Default Encoding” can be specified on the PO, which will be a 26A bit format and Allegion will choose the facility code and starting badge ID number. For all other encoding guidance, contact your Allegion Sales Consultant or electronicsidesales@allegion.com before proceeding.
- When ordering multi-technology credentials, the order requires credential encoding information for both the Smart and Proximity technologies if different encoding is preferred. One CT account can also be specified for each technology. The same encoding will be applied to both technologies if there is only one set of encoding information.
- For CardTrax™ restricted program members only.

Sample credential model number

8543M1 - Schlage MIFARE DESFire EV3 Smart Card 4K byte/16K bit with Magnetic stripe ISO Glossy White

Available form factors

Dimensions (HWT in inches)					
Clamshell	ISO - Glossy white	Keyfob	Thin keyfob	Wristband	PVC adhesive disk / PVC adhesive patch
3.37 x 2.125 x 0.075	3.37 x 2.125 x 0.033	2 x 1.24 x 0.038	1.77 x 1.18 x 0.06	0.63 x 7.68 x 0.295	(35mm) 3.37 x 2.125 x 0.033

Allegion offers an optional magnetic stripe encoding service. “Magnetic Stripe” Part Number and encoding instructions would need to be supplied as a separate line item on your purchase order. Please see page 20 for details.

4) Slot punch

Available option on ISO cards. Vertical slot punch is always included in Clamshell credential (no extra charge). Punch indicator dots are on all stock ISO cards. ISO cards with mag stripe can only be punched horizontally. A per-card cost applies for this service. Reference page 20 for details. Allegion is not responsible for damage caused by slot punching provided on Schlage cards by any third party.

5) Card print scheme

Card print schemes are printed in various locations on ISO and clamshell cards and provide information about the credential or order. Print scheme 01 will be used if no other print scheme is specified. Please reference page 22 for available print schemes.

6) Custom artwork number

Please reference page 21 for more information on custom artwork.

7) Special instructions

Please include additional special instructions for your order. Most orders will not have special instructions. Special instructions may include a Cross Reference Sheet or a custom configuration (“CE-xxx-xxx” number). Custom configurations may also be associated with your CardTrax Account and would be automatically applied when a CT Number is specified on the order. A Cross Reference Sheet is a .CSV file containing all badge properties from your order that is used for advanced enrollment functions. Please see page 20 for more information on Cross Reference Sheets.

For more information and guidance placing a credential order, visit our [Credentials How-to-Order Guide](#). You are encouraged to attach a populated Credential Order Template to your purchase order.



SCHLAGE CREDENTIAL TECHNOLOGY TYPES

Schlage offers a wide range of credential technologies and form factors.

Mobile credentials

Schlage offers a variety of ways to deliver mobile credentials to your students' and employees' phones. Using near field communication (NFC) or Bluetooth technology, a smartphone app works just like an ID card, providing more for your students and employees while enhancing the security of their credential. Easily assign credentials today using the access control software of one of our developer network partners. Schlage mobile credentials offer the highest level of credential security available.

Smart credentials

Ideal for facilities with moderate to high security needs, Schlage 13.56 MHz smart credentials put you in control by delivering smarter solutions. Using MIFARE® DESFire®'s EV Series or MIFARE Classic®, these credentials protect your most sensitive data by utilizing extra layers of security protection. Smart credentials can be used for many applications beyond access control including transit, cashless vending, and cafeteria point of sale.

Multi-technology credentials

Schlage multi-technology credentials are extremely flexible. Particularly useful during a transition from proximity technology to smart technology, these cards can be read by both proximity readers and smart readers. This allows your customers to economically migrate to the latest smart technology at their own pace.

Proximity credentials

Schlage proximity credentials are a solution for facilities with less demanding security needs. Utilizing 125 kHz proximity technology, these credentials are a cost-effective solution and can interface with many industry leading proximity readers.

Magstripe credentials

Schlage magstripe credentials are a solution for facilities with less demanding security needs. Utilizing magstripe technology, these credentials are a cost-effective solution.

CREDENTIAL ORDER TEMPLATE (Populate the applicable fields—Required: 1, 2, 3A or 3B)													
1	2	3A		OR	3B Manual Encoding				4 Advanced Options				
Model number	Qty	Technology	CardTrax Account #		Bit Format	Facility Code (Site Code)	City Code (for 48X only)	Badge ID Start Number (Default: Offset = 0, Encoded/Printed match)		Print Scheme (Default: 01)	Slot Punch (Default: No) No/SPV/SPH	Custom Artwork (CA#####)	CRS Y/N
		Smart (13.56 MHz)		SKIP 3B IF USING CARDTRAX				Encoded ID Start		Depends on Model Number. See Schlage Electronics Pricebook for details. Skip if Default or N/A.			
		Proximity (125 kHz)						Printed ID Start					
									Encoded ID Start				
								Printed ID Start					
		Skip to 3B for manual encoding.			Default: Encoding will match on both techs when using multi-tech credentials unless otherwise specified.		Difference between Encoded ID (internal) and Printed ID (external) = Offset.						

Please submit orders to Allegion_Orders@allegion.com with purchase order. Orders are not required to be in this format, but either all encoding details or a CardTrax number must be clearly provided on the purchase order.

EXAMPLE ORDER - Single technology credential with CardTrax account, default print scheme, horizontal slot punch, and cross reference sheet

1	2	3A		OR	3B Manual Encoding				4 Advanced Options			
Model number	Qty	Technology	CardTrax Account #		Bit Format	Facility Code (Site Code)	City Code (for 48X only)	Badge ID Start Number (Default: Offset = 0, Encoded/Printed match)		Print Scheme (Default: 01)	Slot Punch (Default: No) No/SPV/SPH	Custom Artwork (CA#####)
8543M1	500	Smart (13.56 MHz)	CT123456					Encoded ID Start		01	SPH	Y
		Proximity (125 kHz)						Printed ID Start				
									Encoded ID Start			
								Printed ID Start				

By default, magnetic stripe (M1) will not be programmed. If you need magnetic stripe programming, please reach out to your Allegion Sales Consultant before placing your order. Please be prepared to provide specific encoding details.

EXAMPLE ORDER - Multi-technology credential with manual encoding details, no offset, and 04 print scheme (see page 22)

1	2	3A		OR	3B Manual Encoding				4 Advanced Options			
Model number	Qty	Technology	CardTrax Account #		Bit Format	Facility Code (Site Code)	City Code (for 48X only)	Badge ID Start Number (Default: Offset = 0, Encoded/Printed match)		Print Scheme (Default: 01)	Slot Punch (Default: No) No/SPV/SPH	Custom Artwork (CA#####)
8943	200	Smart (13.56 MHz)			37X	2		Encoded ID Start	200	04		N
		Proximity (125 kHz)						Printed ID Start	200			
									Encoded ID Start			
								Printed ID Start	200			





SCHLAGE MOBILE ACCESS VIA ENGAGE™

Description	Model number	Price
1-Year Flexible Schlage Mobile Credential License (minimum order of 10)	SMA-ENGAGE-FLEX-1YR	\$6.00
5-Year Fixed Schlage Mobile Credential License (minimum order of 10)	SMA-ENGAGE-FIX-5YR	\$10.00

SCHLAGE CREDENTIAL PACKS

- Minimums do not apply to credential pack
- Allegion chooses facility code and badge ID range which will be printed on the credential
- For 8843T-37X-50 and 9691T-26A-50 packs, Smart and Prox encoding will match
- Credential packs do not prevent against possible badge ID duplication between orders placed at different times

Description	Model number	Price
Schlage 13.56 MHz MIFARE DESFire EV3 ISO Card pre-encoded with standard 37 bit format (37X) in packs of 50. H10304 compatible.	8543-37X-50	\$520.00
Schlage 13.56 MHz MIFARE DESFire EV3 and 125 kHz Proximity Combo Thin Fob pre-encoded with standard 37 bit format (37X) in packs of 50. Smart and Prox encoding will match. H10304 compatible.	8843T-37X-50	\$815.00
Schlage 13.56 MHz MIFARE Classic ISO Card pre-encoded with standard 26 bit format (26A) in packs of 50. H10301 compatible.	9520-26A-50	\$365.00
Schlage 13.56 MHz MIFARE Classic and 125 kHz Proximity Combo Thin Fob pre-encoded with standard 26 bit format (26A) in packs of 50. Smart and Prox encoding will match. H10301 compatible.	9691T-26A-50	\$680.00
Schlage Construction Thick Fob pre-encoded in packs of 25. For use with Schlage Control BE467/FE410.	9651-CONSTRUCTION-25	\$250.00
Schlage 125 kHz Proximity ISO Card pre-encoded with standard 26 bit format (26A) in packs of 50. H10301 compatible.	7510-26A-50	\$360.00

SCHLAGE SMART CREDENTIALS USING MIFARE® DESFIRE® EV3 TECHNOLOGY

- 13.56 MHz smart technology
 - Uses MIFARE DESFire EV3 Technology
 - Meets ISO standard 14443A
- (Minimum order is 100)

Description	Model number	Price
Schlage MIFARE DESFire EV3 4K byte/32K bit Clamshell Card	8443	\$9.50
Schlage MIFARE DESFire EV3 4K byte/32K bit ISO Glossy White	8543	\$10.40
Schlage MIFARE DESFire EV3 4K byte/32K bit with Magnetic stripe ISO Glossy White	8543MI	\$11.40
Schlage MIFARE DESFire EV3 4K/32K bit Thin Fob (minimum order of 50)	8643T	\$10.80
Schlage MIFARE DESFire EV3 4K byte/32K bit ISO Glossy White with Laser Grade Overlay ¹	8543L	\$10.60
Schlage MIFARE DESFire EV3 4K byte/32K bit with Magnetic Stripe ISO Glossy White with Laser Grade Overlay ¹	8543MIL	\$11.60

MULTI-TECHNOLOGY: PROXIMITY AND SCHLAGE SMART CREDENTIALS USING MIFARE® DESFIRE® EV3 (Minimum order is 100)

Description	Model number	Price
Proximity and Schlage MIFARE DESFire EV3 4K byte/32K bit Thin Fob (minimum order of 50)	8843T	\$16.30
Proximity and Schlage MIFARE DESFire EV3 4K byte/32K bit ISO Glossy White	8943	\$15.20
Proximity and Schlage MIFARE DESFire EV3 4K byte/32K bit with Magnetic stripe ISO Glossy White	8943MI	\$16.20
Proximity and Schlage MIFARE DESFire EV3 4K byte/32K bit ISO Glossy White with Laser Grade Overlay ¹	8943L	\$15.40
Proximity and Schlage MIFARE DESFire EV3 4K byte/32K bit with Magnetic Stripe ISO Glossy White with Laser Grade Overlay ¹	8943MIL	\$16.10

1. Laser Grade Overlay is an additional overlay on top of the card that enhances print quality and improves longevity.

SCHLAGE MIFARE® DESFIRE® EV1 TECHNOLOGY

- 13.56 MHz smart technology
 - Uses MIFARE DESFire EV1 Technology
 - Meets ISO standard 14443A
- (Minimum order is 100)

Description	Model number	Price
Schlage MIFARE DESFire EV1 Smart Card 4K byte/32k bit Clamshell	8440 ☒	\$10.00
Schlage MIFARE DESFire EV1 Smart Card 4K byte/32k bit ISO Glossy White	8540	\$10.40
Schlage MIFARE DESFire EV1 Smart Card 4K byte/32k bit with Magnetic stripe ISO Glossy White	8540MI	\$11.40
Schlage MIFARE DESFire EV1 Smart 4K byte/32k bit PVC Adhesive Patch	8740 ☒	\$9.90

MULTI-TECHNOLOGY: SCHLAGE MIFARE® DESFIRE® EV1 AND PROXIMITY (Minimum order is 100)

Description	Model number	Price
Proximity and Schlage Smart Card Combo 4K byte/32k bit ISO Glossy White	8940	\$15.20
Proximity and Schlage Smart Card Combo 4K byte/32k bit with Magnetic stripe ISO Glossy White	8940MI ☒	\$16.20

☒ Longer lead times expected.

DISCONTINUED MIFARE® DESFIRE® CREDENTIALS

Please Note: Recommended alternatives will match in form factor, likely be in a different credential technology, still be functionally comparable, and may vary in memory size.

Description	Discontinued model number	Alternatives	
Schlage MIFARE DESfire EV2 2K byte/16K bit Clamshell Card	2420	8440	8443
Schlage MIFARE DESfire EV2 4K byte/32K bit Clamshell Card	2440	8440	8443
Schlage MIFARE DESfire EV2 8K byte/64K bit Clamshell Card	2480	8440	8443
Schlage MIFARE DESfire EV2 2K byte/16k bit ISO Glossy White	2520	8540	8543
Schlage MIFARE DESfire EV2 4K byte/32k bit ISO Glossy White	2540	8540	8543
Schlage MIFARE DESfire EV2 8K byte/64k bit ISO Glossy White	2580	8540	8543
Proximity and Schlage MIFARE DESfire EV2 2K byte/16k bit ISO Glossy White	2920	8943	
Proximity and Schlage MIFARE DESfire EV2 4K byte/32k bit ISO Glossy White	2940	8943	
Proximity and Schlage MIFARE DESfire EV2 8K byte/64k bit ISO Glossy White	2980	8943	
Schlage MIFARE DESFire EV1 Smart Card 2K byte/16k bit Clamshell	8420	8440	8443
Schlage MIFARE DESFire EV1 Smart Card 8K byte/64k bit Clamshell	8480	8440	8443
Schlage MIFARE DESFire EV1 Smart Card 2K byte/16k bit ISO Glossy White	8520	8540	8543
Schlage MIFARE DESFire EV1 Smart Card 8K byte/64k bit ISO Glossy White	8580	8540	8543
Proximity and Schlage Smart Card Combo 2K byte/16k bit ISO Glossy White	8920	8943	
Proximity and Schlage Smart Card Combo 8K byte/64k bit ISO Glossy White	8980	8943	
Schlage MIFARE DESfire EV2 2K byte/16k bit with Magnetic stripe ISO Glossy White	2520M1	8540M1	8543M1
Schlage MIFARE DESfire EV2 4K byte/32k bit with Magnetic stripe ISO Glossy White	2540M1	8540M1	8543M1
Schlage MIFARE DESfire EV2 8K byte/64k bit with Magnetic stripe ISO Glossy White	2580M1	8540M1	8543M1
Schlage MIFARE DESfire EV2 2K Thin Fob	2620T	8643T	
Schlage MIFARE MIFARE DESfire EV2 2K + HID Compatible Prox Thin Fob	2692T	8843T	
Proximity and Schlage MIFARE DESfire EV2 2K byte/16k bit with Magnetic stripe ISO Glossy White	2920M1	8940M1	8943M1
Proximity and Schlage MIFARE DESfire EV2 4K byte/32k bit with Magnetic stripe ISO Glossy White	2940M1	8940M1	8943M1
Proximity and Schlage MIFARE DESfire EV2 8K byte/64k bit with Magnetic stripe ISO Glossy White	2980M1	8940M1	8943M1
Schlage MIFARE DESFire EV1 Smart Card 2K byte/16k bit with Magnetic stripe ISO Glossy White	8520M1	8540M1	8543M1
Schlage MIFARE DESFire EV1 Smart Card 8K byte/64k bit with Magnetic stripe ISO Glossy White	8580M1	8540M1	8543M1
Proximity and Schlage Smart Card Combo 2K byte/16k bit with Magnetic stripe ISO Glossy White	8920M1	8940M1	8943M1
Proximity and Schlage Smart Card Combo 8K byte/64k bit with Magnetic stripe ISO Glossy White	8980M1	8940M1	8943M1
Schlage MIFARE DESFire EV1 Smart 2K byte/16k bit PVC Adhesive Patch	8720	8740	
Schlage MIFARE DESFire EV1 Smart 8K byte/64k bit PVC Adhesive Patch	8780	8740	

SCHLAGE MIFARE CLASSIC®

- 13.56 MHz smart technology
- Uses MIFARE Technology
- Meets ISO standard 14443A

(Minimum order is 100)

Description	Model number	Price
Schlage MIFARE Classic Smart Card 2.5k bit Clamshell	9420	\$5.80
Schlage MIFARE Classic Smart Card 1K byte/8k bit Clamshell	9451	\$9.00
Schlage MIFARE Classic Smart Card 2.5k bit ISO Glossy White	9520	\$7.30
Schlage MIFARE Classic Smart Card 1K byte/8k bit ISO Glossy White	9551	\$8.80
Schlage MIFARE Classic Smart Card 4K byte/32k bit ISO Glossy White	9558	\$12.40
Schlage MIFARE Classic Smart Card 2.5k bit with Magnetic stripe ISO Glossy White	9520M1	\$8.10
Schlage MIFARE Classic Smart Card 1K byte/8k bit and Magnetic stripe ISO Glossy White	9551M1	\$9.60
Schlage MIFARE Classic Smart Card 4K byte/32k bit and Magnetic stripe ISO Glossy White	9558M1	\$13.30
Schlage MIFARE Classic Smart 1K byte/8k bit Keyfob (minimum order is 50)	9651	\$10.10
Schlage MIFARE Classic Smart 1K byte/8k bit Thin Keyfob (minimum order is 50)	9651T	\$10.30
Schlage MIFARE Classic Smart 1K byte/8k bit PVC Adhesive Patch	9751	\$9.10
Schlage MIFARE Classic Smart 4K byte/32k bit PVC Adhesive Patch	9758	\$13.70

MULTI-TECHNOLOGY: SCHLAGE MIFARE CLASSIC® AND PROXIMITY

(Minimum order is 100)

Description	Model number	Price
Proximity and Schlage Smart Combo 1K byte/8k bit Thin Keyfob (minimum order is 50)	9691T	\$13.60
Proximity and Schlage Smart Card Combo 1K byte/8k bit ISO Glossy White	9951	\$12.20
Proximity and Schlage Smart Card Combo 4K byte/32k bit ISO Glossy White	9958	\$14.30
Proximity and Schlage Smart Card Combo 1K byte/8k bit with Magnetic stripe ISO Glossy White	9951M1	\$12.60
Proximity and Schlage Smart Card Combo 4K byte/32k bit with Magnetic stripe ISO Glossy White	9958M1	\$15.10

SCHLAGE MIFARE CLASSIC® WRISTBANDS

(Minimum order is 100)

Description	Model number	Price
Schlage MIFARE Classic 1K byte/8k bit Silicone Wristband (minimum order is 100) Available in six colors	9351-XXX	\$13.10
Black BLK Orange ONG		
Blue BLU Purple PLE ☒		
Green GRN ☒ Red RED ☒		

☒ Longer lead times expected.



SCHLAGE PROXIMITY CREDENTIALS

- 125 kHz proximity technology
- Compatible with most HID Proximity formats up to 37 bits
- Compatible with most HID readers

(Minimum order is 50)

125 khz Proximity Credentials Comparison Guide

Description	Model number	Price	HID® product number
Proximity card - Clamshell (minimum order is 100)	7410	\$4.30	1326
Proximity card - ISO Glossy White (minimum order is 100)	7510	\$7.20	1386/1586
Proximity and magnetic stripe card - ISO Glossy White (minimum order is 100)	7510M1	\$8.10	1336/1536
Proximity keyfob (minimum order is 50)	7610	\$7.50	1346
Proximity PVC adhesive disk (35 mm Disk)	7010 ☒	\$6.90	1391
Proximity thin keyfob (minimum order is 50)	7610T	\$8.00	
Combo Keyfob, 125 kHz Proximity and iButton	IBF-110 ☒	\$16.50	
Combo Key FOB, 125kHz Proximity and iButton, user Blue	IBF-120 ☒	\$23.00	
Combo Keyfob, 125 kHz Proximity without iButton	IBWB-110 ☒	\$6.30	

Please note: This chart offers comparable part numbers; these are **not** direct replacements. Please use this chart as a guide and reference the spec sheet for the part specified to determine compatibility.

☒ Longer lead times expected.

MAGNETIC STRIPE ONLY CREDENTIALS

(Minimum order is 100)

Description	Model number	Price
Magnetic stripe card - Not encoded, no logo	MAG1	\$3.40
Magnetic stripe card - Encoded (track 2 and track 3) with Schlage logo	MAG2	\$4.40
Magnetic stripe card - Encoded, no printing. Must have an enrollment reader to use this credential	MAG3	\$4.40

Schlage and the Schlage logo are trademarks of Allegion plc, its subsidiaries and/or affiliates in the United States and other countries. All other trademarks are the property of their respective owners.





SLOT PUNCH OPTIONS

Description	Specify	Price
Vertical slot punch for ISO Cards (not available for magnetic stripe cards). MUST BE ORDERED WITH CARDS.	SPV	\$0.60 per card
Horizontal slot punch for ISO Cards, including those with magnetic stripe. MUST BE ORDERED WITH CARDS.	SPH	\$0.60 per card

ENCODING FEE

Description	Specify	Price
Magnetic stripe encoding fee	Magnetic Stripe	\$1.10 per card

CUSTOM ARTWORK

Description	Specify	Price
One-sided printed artwork fee	One-Sided	\$0.24 per card
Two-sided printed artwork fee	Two-Sided	\$0.36 per card

Note: Custom artwork print charges are net price adders.
See page 21 for more information on Minimum Order Quantities.

SCHLAGE CUSTOM ENCRYPTION KEY SERVICE

Description	Specify	Price
<p>Schlage Custom Encryption Key Service</p> <ul style="list-style-type: none"> Allegion will create a symmetric Mifare DESFire custom encryption key that is unique to a single end-user customer. This adds an elevated layer of security and cross-manufacturer interoperability to the site when applied to credentials, readers, and intelligent locking hardware. Customers should contact their Allegion Sales Consultant or email CardTrax@Allegion.com to request the latest version of the SCEKS application. Before placing a Purchase Order where the SCEKS is intended to be used, the customer MUST have completed the application process and received a Custom Encryption ID Number (CAxxxx). See page 23 for details. 	SCEKS	<p>USA: No charge</p> <p>Canada: Call for quote</p>

CROSS REFERENCE SHEET

Description	Specify	Price
<p>A Credential Cross Reference Sheet (CRS) file can be provided with a credential order and contains the credential encoding details in a .csv format, commonly used for Active Directory imports to access control software.</p> <p>The Cross Reference Sheet MUST be included as its own line item on a Purchase Order (PO) to be included with the order.</p>	Cross Reference Sheet	No charge

CUSTOM ARTWORK

Cards with custom artwork offer a way to stand out from the crowd and creatively express features of your institution or business. Display your company logo, showcase unique artwork, or convey a uniform message with custom artwork. How does it work? The process varies depending on whether this is a first-time purchase using your artwork or placing a repeat order.

United States

New, first-time artwork / Updating existing artwork:

1. Contact Inside Sales at CustomArtwork@allegion.com to begin your new custom artwork request or change request. Artwork file requirements will be provided.
2. Once you review the requirements, you can provide us with your compliant artwork file.
 - a. Include a reference to CMYK in the art template, an .AI, .EPS, or .TIF file, a print scheme (see page 22), and credential encoding specifications for the first order.
 - b. The Minimum Order Quantity (MOQ) on new custom artwork orders must be 1,000 or more. This applies to all first-time artwork orders and orders with updated artwork (including any changes to image, text, layout, or positioning).
3. A quote and artwork proof will be created and provided digitally for review and approval. Upon approval and signature, a new CA number will be assigned to your artwork file.
4. Each order will require the artwork proof to be re-confirmed in email to eliminate any miscommunication.
5. Upon request from Allegion, submit a completed purchase order to CustomArtwork@allegion.com. The PO must contain your new CA number and credential encoding specifications that were initially provided in the CA application Allegion will cross-check the encoding specs and will begin producing your credentials.

Repeat artwork orders:

1. If you've purchased Custom Artwork credentials using the exact artwork template before, the MOQ is reduced to 500.
2. Contact Inside Sales at CustomArtwork@allegion.com to begin your repeat custom artwork order process.
3. Upon request from Allegion, submit a completed purchase order to CustomArtwork@allegion.com. The PO must contain your CA number and credential encoding specifications. Allegion will cross-check the encoding specs and will begin producing your credentials.

Notes:

- There is an extended lead time on all orders that begins when the Sales Order Acknowledgement is received (not when the order is submitted). Lead times may increase during periods of peak demand. It is recommended that orders be placed well ahead of the required need-by date.
- Custom artwork is available for all ISO glossy white and clamshell cards.
- The artwork design must fit within the space allotted.
- Physical samples can be provided with an extended lead time.
- Contact Inside Sales at CustomArtwork@allegion.com with any questions throughout the process.

Canada

For Custom Artwork order requests in Canada, contact Canada.CustomerService@allegion.com.



PRINT SCHEME OPTIONS (PS#)

ID numbers are printed on the back of the cards. All the cards shown are picture samples for ID number locations only. Other variables on the card, such as logo and slot punch location are dependent on choices indicated on the Credential Order Form. Please indicate the print scheme option you would like on your purchase order. If a print scheme isn't selected, the default 01 print scheme will be provided.

KEY	
T	Technology
├─ P	Proximity
├─ S	Smart
└─ C	Combo/multi
FFF	Bit format (fixed)
SSSS	Order number (fixed)
BID	Badge ID number
PN	Existing printed PN from supplier

01 (Default)

ISO card with technology, bit format, order number and badge ID, bottom right hand corner

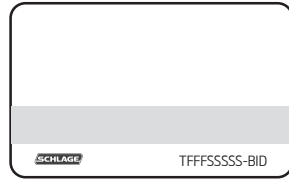

02

ISO card with badge ID, bottom right hand corner

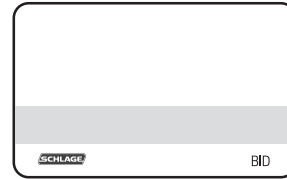

03

ISO card with technology, bit format, Order number and badge ID, upper right hand corner

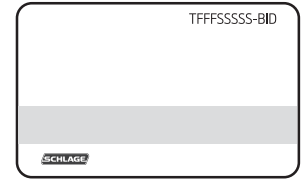

04

ISO card with badge ID, upper right hand corner

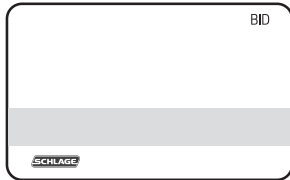

05

ISO card with technology, bit format, order number and badge ID, upper left hand corner

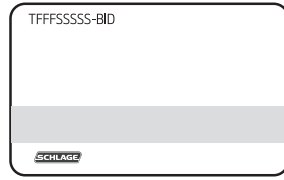

06

ISO card with badge ID, upper left hand corner



07

ISO card with technology, bit format, Order number and badge ID, bottom left hand corner

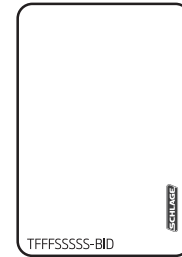

08

ISO card with badge ID, bottom left hand corner

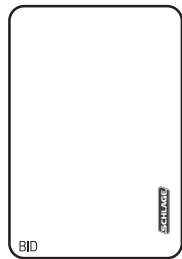

09

Clamshell card with technology, bit format, order number and badge ID, bottom right hand corner



10

Clamshell card with badge ID, bottom right hand corner



11

Clamshell card with technology, bit format, order number and badge ID, bottom left hand corner

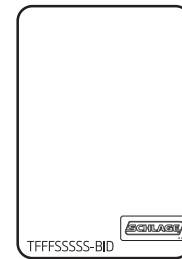

12

Clamshell card with badge ID, bottom left hand corner

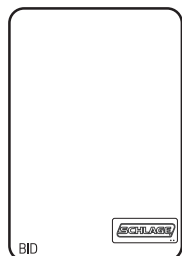

13

Clamshell card with existing supplier part number, 881, lower left hand corner

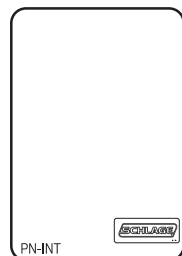

14

ISO card with existing supplier part number, 881, lower right hand corner



15

No numbers printed





CARDTRAX™ CREDENTIAL SEQUENCING SERVICE

Thank you for your interest in CardTrax™, a credential order sequencing service designed for individual end users or integrator/OEMs to ensure card numbers are never duplicated.

There are two types of CardTrax accounts available: Standard CardTrax™ and Restricted CardTrax™.

Standard CardTrax accounts are available for end users, PACS/OEM's and integrator customers. The account will track bit format, facility code, and badge ID information. It will not allow duplicates to be sent to that specific customer.

Restricted CardTrax accounts (bit formats 35C and 40X) are reserved for end users only. This type of account will track bit format facility code and badge ID information. The bit format and facility code combination can only be registered by one end user, and once registered it is not available to any other end user.

Purchases using a CardTrax account are limited to authorized vendors that are designated by the account manager of that account. To begin the application process, or to make changes to your existing CardTrax account, please contact your Allegion Sales Consultant or email CardTrax@Allegion.com requesting the latest version of the CardTrax application form.

Linking your CardTrax account to your SCEKS

End users with custom encryption keys (see page 20 for information on the Schlage Custom Encryption Key Service) can link their new or existing Custom Encryption ID number (CAxxxx) to a new or existing CardTrax account. After the link is complete, orders can be placed using just the respective CardTrax Account number (on the PO) and credentials will be both sequenced and encrypted with the end user's site-specific encryption during production.

Once a CardTrax account is linked to a custom encryption key, that CardTrax account will only produce credentials with custom encryption going forward. End user sites should plan accordingly to minimize the impact of an encryption key shift - including updating readers/electrified locks with new encryption and a replacement plan for old credentials. Contact your Allegion Sales Consultant for assistance navigating this change.

Linking your new custom encryption key to a CardTrax account is **highly recommended** to streamline credential purchases and purchaser authorization.

Contents

Networked readers | Overview..... 24

Networked readers.....27

- Multi-technology readers27
- Magnetic stripe readers27
- Contactless Smart Card readers.....27
- Proximity readers27

Reader parts and accessories..... 28

- Reader replacement parts28
- MTB Series Reader covers.....28
- MT Series Reader covers28
- SM/PR Series Reader covers.....29

Enrollment readers/Keypads 30

- Enrollment readers for Schlage Express30
- Enrollment readers.....30
- OEM Module30

Schlage reader command cards 31

- Keypad settings31
- Audio visual settings.....31
- Card serial number (CSN) or unique identifier (UID) settings..32
- Smart Card settings32
- PIV settings.....32
- Reader performance settings34

Customer service	Technical support	Inside sales
<ul style="list-style-type: none"> ▪ Order status ▪ Credit returns of non-defective products ▪ General sales questions 	<ul style="list-style-type: none"> ▪ Technical questions/issues ▪ Returns of defective products ▪ Repairs 	<ul style="list-style-type: none"> ▪ General sales questions ▪ Custom Artwork credentials ▪ CardTrax™ accounts
USA Email Requests to: Sales Support Contact information on Page 2. CAN Canada.CustomerService @allegion.com	USA Readers_Credentials_Biometrics_ TechProdSupport@allegion.com CAN Canada.TechServices @allegion.com	USA ElectronicInsideSales@allegion.com CAN Canada.CustomerService @allegion.com

READERS OVERVIEW

With our versatile mobile enabled multi-technology, multi-technology, smart and proximity reader options, we have a solution for any physical access control need. Our comprehensive, yet simple reader line-up is suitable for any new mobile, smart or proximity installation.

Schlage Mobile Enabled Multi-technology readers (MTB Series)

Schlage mobile enabled multi-technology readers are ideal for any new mobile or smart installation—or as a cost-effective way to migrate from existing proximity to smart or mobile technology.

- 125 kHz proximity, 13.56 MHz smart and 2.4 GHz Bluetooth technology in one reader
- Compatible with Bluetooth and NFC-open smart phones
- Reads ISO 14443 A/B and 15693 credentials
- Compatible technologies include:
 - DESFire® CSN, HID iCLASS® CSN, Inside Contactless PicoTag® CSN, ST Microelectronics® CSN, Texas Instruments Tag-It® CSN, Phillips I-Code® CSN
 - Schlage® Proximity, HID® Proximity, GE/CASI® Proximity, AWID® Proximity, LenelProx®
 - Schlage MIFARE® DESFire® EV1 and EV3, Schlage MIFARE Classic®, Schlage MIFARE Plus®2
 - Schlage mobile credentials using NFC technology
- Wiegand, Clock & Data and RS-485 (OSDP, OSDP Secure) interfaces are standard
- Plug and Play mode for straight out of the box functionality
- Commission via ENGAGE™ mobile app for reader updates and easy configuration.
- Improved voltage range of 5V to 28V for simplified power management
- Tri-state LED (red, green, amber) and audible status alert
- Standard color is black. Cream is available as an option, longer lead times may apply.

Schlage Multi-technology readers (MT Series)

Schlage multi-technology readers are ideal for any new smart, proximity, or magnetic stripe installation—or as a cost effective way to migrate from existing magnetic stripe or proximity to smart technology.

- 125 kHz proximity and 13.56 MHz contactless smart card technology in one reader
- Magnetic stripe option, reads track 2 default, tracks 1 and 3 configurable
- Reads ISO 14443 A/B and 15693 credentials
- Compatible with:
 - Schlage MIFARE® DESFire® EV1 and EV3, Schlage MIFARE Classic®, Schlage MIFARE Plus®
 - Schlage mobile credentials using NFC technology
 - Most popular proximity credentials including Schlage, XceedID, HID®, GE/Casi ProxLite®, AWID®, and LenelProx®
 - CSN of most existing 13.56 MHz credentials
 - Magnetic stripe
- Wiegand interface (RS-485 available)
- FIPS 201-2 compliant
- Tri-state LED (red, green, amber) and audible status alert
- Standard color is black. Gray, brown and cream colors are available, longer lead times may apply.

Schlage Smart Readers (SM Series)

The Schlage smart mini-mullion reader is an excellent option for a smart-only installation.

- 13.56 MHz single frequency contactless smart card technology
- Reads ISO 14443 A/B and 15693 credentials
- Compatible with:
 - Schlage MIFARE® DESFire® EV1 and EV3, Schlage MIFARE Classic®, Schlage MIFARE Plus®
 - Schlage mobile credentials using NFC technology
 - CSN of most existing 13.56 MHz credentials
- Wiegand interface
- Tri-state LED (red, green, amber) and audible status alert
- Standard color is black. Gray, brown and cream colors are available, longer lead times may apply.

Schlage Proximity Readers (PR Series)

This mini-mullion reader is a great solution for proximity-only facilities.

- 125 kHz single frequency proximity technology
- Compatible with:
 - Most popular proximity credentials including Schlage, XceedID, HID®, GE/Casi ProxLite®, AWID®, and LenelProx®
- Tri-state LED (red, green, amber) and audible status alert
- Wiegand interface
- Standard color is black. Gray, brown, and cream colors are available, longer lead times may apply.

HOW TO ORDER

Follow the steps below to build the full part number for the reader you wish to order. Use the sample below to determine how to write your part number on your PO.

MOBILE ENABLED MULTI-TECHNOLOGY READERS

Example: MTK15 - 485 - C - PIV8

1. Reader model number
See page 34
2. Communication protocol
Standard includes Wiegand, Clock & Data, RS-485 (OSDP, OSDP Secure)
3. Color option
Black (standard) – leave blank
Cream – add “C”
4. Custom Format or leave blank

MULTI-TECHNOLOGY READERS

Example: MTK15 - 485 - C - PIV8

1. Reader model number
See page 27
2. Communication protocol
Standard includes Wiegand, Clock & Data
Optional: Specify “-485” (RS485, OSDP, Wiegand)
3. Color option
Black (standard) – leave blank
Cream – add “C”
Warm-tone brown – add “BN”
Cool-tone grey – add “G”
4. PIV or Custom Format or leave blank
Optional; Specify PIV Format (see chart at right for formats)

SINGLE TECH READERS

Example: SM10 - - G -

1. Reader model number
See page 27
2. Communication protocol
Standard includes Wiegand, Clock & Data
3. Color option
Black (standard) – leave blank
Cream – add “C”
Warm-tone brown – add “BN”
Cool-tone grey – add “G”
4. PIV format
N/A

1. Choose your reader model

See next page for available models.

2. RS-485 capability

Schlage mobile enabled multi-technology readers (MTB Series) have been designed to interface directly with controllers that utilize RS-485 protocol as a standard feature. Schlage multi-technology readers (MT Series) have been designed with an option to interface directly with controllers that utilize RS-485 protocol. RS-485 is a communication protocol that allows a two way communication between the reader and the panel, for example OSDP protocol.

3. Reader color options

Schlage readers are available in four color options. Add the appropriate suffix after the reader model number for a cover color other than black. Please note the Schlage mobile enabled multi-technology readers (MTB Series) are only available in black and cream.

- Black (standard) – do not add a color suffix, **leave blank**
- Cream – **add “C”**
- Warm-tone brown – **add “BN”**
- Cool-tone grey – **add “G”**

4. PIV format

The Schlage multi-technology readers (MT Series) use 75-bit PIV as the default format. Other format requirements are determined by the access control system, agency requirements, and customer specifications. The other available formatting options are listed below. Add “PIV” and the format number after the reader model number, RS-485 option (if applicable), and color suffix (if applicable). PIV Formats are not available on the Schlage mobile enabled multi-technology readers (MTB Series).

FORMAT NUMBER	BIT INFORMATION
1	75-bit PIV
2	58-bit TWIC/CAC
3	200-bit FASC-N
4	64-bit (BCD) TWIC/CAC
5	83-bit TWIC/CAC
6	66-bit (58-bit format + TSM) TWIC/CAC
7	64-bit (58-bit format (no parity) + TSM) TWIC/CAC
8	91-bit (83 bit format + TSM) TWIC/CAC
9	40-bit BCD
10	40-bit reversed BCD
11	64-bit BCD
12	64-bit reversed BCD
13	128-bit BCD
14	128-bit reversed BCD
15	58-bit HSE

If you need assistance in determining the PIV format for your facility, please contact your Allegion sales representative directly.

5. Special Instructions

Please specify any other special instructions directly on your PO. Readers can be ordered from the factory with custom configurations. This service may add 4-8 days to shipping time. The same can be achieved by configuring in the field.

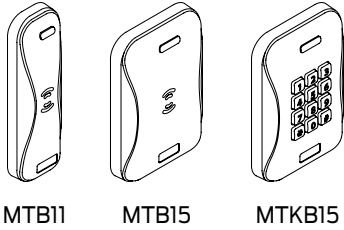

MTB11 MTB15 MTKB15

SCHLAGE MOBILE ENABLED MULTI-TECHNOLOGY READERS

- Power required: 5-24 VDC

Description	Model number	Price
Mullion mount, dimensions: 5.91" x 1.72" x 0.81"	MTB11	\$404.00
Wall mount, dimensions: 5.1" x 3.25" x 0.76"	MTB15	\$404.00
Wall mount with keypad, dimensions: 5.1" x 3.25" x 0.76"	MTKB15	\$652.00

1. Wiegand and RS-485 | OSDP capability included in standard product offering.

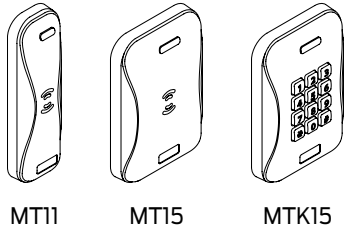

MT11 MT15 MTK15

SCHLAGE MULTI-TECHNOLOGY READERS

- Power required: 5-16 VDC

Description	Model number	Price
Mullion mount, dimensions: 5.91" x 1.72" x 0.81"	MT11	\$395.00
Wall mount, dimensions: 5.1" x 3.25" x 0.76"	MT15	\$395.00
Wall mount with keypad, dimensions: 5.1" x 3.25" x 0.76"	MTK15	\$633.00
Mullion mount, dimensions: 5.91" x 1.72" x 0.81"	MT11-485	\$395.00
Wall mount, dimensions: 5.1" x 3.25" x 0.76"	MT15-485	\$395.00
Wall mount with keypad, dimensions: 5.1" x 3.25" x 0.76"	MTK15-485	\$633.00

Note: Readers with -485 are for OSDP or RS-485 installations. Readers without -485 are for Wiegand wiring installations.

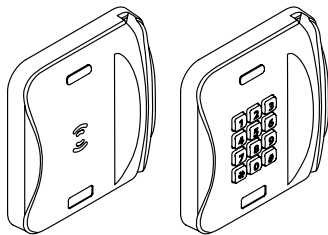

MTMS15 MTMSK15

SCHLAGE MULTI-TECHNOLOGY MAGNETIC STRIPE READERS

- Power required: 5-16 VDC

Description	Model number	Price
Wall mount, dimensions: 5.17" x 4.43" x 1.15"	MTMS15	\$842.00
Wall mount with keypad, dimensions: 5.17" x 4.43" x 1.15"	MTMSK15	\$1,139.00
Wall mount, dimensions: 5.17" x 4.43" x 1.15"	MTMS15-485	\$842.00
Wall mount with keypad, dimensions: 5.17" x 4.43" x 1.15"	MTMSK15-485	\$1,139.00

Note: Readers with -485 are for OSDP or RS-485 installations. Readers without -485 are for Wiegand wiring installations.



SM10

SCHLAGE CONTACTLESS SMART CARD READERS

- Power required: 5-16 VDC

Description	Model number	Price
Mini-mullion mount, dimensions: 4.26" x 1.72" x 0.81"	SM10	\$235.00



PR10

SCHLAGE PROXIMITY READERS

Description	Model number	Price
Mini-mullion mount, dimensions: 4.26" x 1.72" x 0.81"	PR10	\$235.00



PARTS AND ACCESSORIES

READER REPLACEMENT PARTS

Description	Specify	Price
MT Series pigtail – 18"	23846462	\$53.60
MTB Series pigtail - 12"	47265286	\$54.00
Screw pack	23933104	\$15.30
Magnetic stripe read head	47252693	\$154.00
Mini-mullion backplate	23846355	\$32.10
Single gang backplate	23846439	\$32.10
Mullion backplate	23846397	\$32.10
Magnetic stripe backplate	24152654	\$65.00
Cosmetic backplate cover – Mini-mullion /mullion (6.70" x 2.50")	CP-11	\$40.00
Cosmetic backplate cover – Single gang (5.65" x 3.85")	CP-15	\$40.00
Cosmetic backplate cover – Mid-range (6.45" x 5.50")	CP-21	\$40.00
Adapter cable, MT connector to MTB reader	47569692	\$24.00

MTB SERIES READER COVERS

- Standard color for readers is black. Cream color is available, longer lead time may apply.

Description	Specify	Price
Mullion - Black, Schlage Bluetooth logo	47317558	\$32.10
Mullion - Cream, Schlage Bluetooth logo	47317562	\$32.10
Single Gang - Black, Schlage Bluetooth logo	47317564	\$32.10
Single Gang - Cream, Schlage Bluetooth logo	47317568	\$32.10
Single Gang with Keypad - Black, Schlage Bluetooth logo	47317570	\$32.10
Single Gang with Keypad - Cream, Schlage Bluetooth logo	47317574	\$32.10

MT SERIES READER COVERS

- Standard color for readers is black. Gray, brown, and cream colors are available, longer lead times may apply.

Description	Specify	Price
Mullion - Black, Schlage logo	47317557	\$32.10
Mullion - Warm-Tone Brown, Schlage logo	47317559	\$32.10
Mullion - Cool-Tone Gray, Schlage logo	47317560	\$32.10
Mullion - Cream, Schlage logo	47317561	\$32.10
Single Gang - Black, Schlage logo	47317563	\$32.10
Single Gang - Warm-Tone Brown, Schlage logo	47317565	\$32.10
Single Gang - Cool-Tone Gray, Schlage logo	47317566	\$32.10
Single Gang - Cream, Schlage logo	47317567	\$32.10
Single Gang with Keypad - Black, Schlage logo	47317569	\$32.10
Single Gang with Keypad - Warm-Tone Brown, Schlage logo	47317571	\$32.10
Single Gang with Keypad - Cool-Tone Gray, Schlage logo	47317572	\$32.10
Single Gang with Keypad - Cream, Schlage logo	47317573	\$32.10
Single Gang Magnetic Stripe - Black, Schlage logo	47317575	\$64.30
Single Gang Magnetic Stripe - Warm-Tone Brown, Schlage logo	47317576	\$64.30
Single Gang Magnetic Stripe - Cool-Tone Gray, Schlage logo	47317577	\$64.30
Single Gang Magnetic Stripe - Cream, Schlage logo	47317578	\$64.30
Single Gang Magnetic Stripe with Keypad - Black, Schlage logo	47317579	\$64.30



PARTS AND ACCESSORIES

MT SERIES READER COVERS

- Standard color for readers is black. Gray, brown, and cream colors are available, longer lead times may apply.

Description	Specify	Price
Single Gang Magnetic Stripe with Keypad - Warm-Tone Brown, Schlage Logo	47317580	\$64.30
Single Gang Magnetic Stripe with Keypad - Cool-Tone Gray, Schlage Logo	47317581	\$64.30
Single Gang Magnetic Stripe with Keypad - Cream, Schlage Logo	47317582	\$64.30

SM/PR SERIES READER COVERS

- Standard color for readers is black. Gray, brown, and cream colors are available, longer lead times may apply.

Description	Specify	Price
Mini-Mullion - Black, Schlage Logo	47317553	\$32.10
Mini-Mullion - Warm-Tone Brown, Schlage Logo	47317554	\$32.10
Mini-Mullion - Cool-Tone Gray, Schlage Logo	47317555	\$32.10
Mini-Mullion - Cream, Schlage Logo	47317556	\$32.10

Note: To receive a cover with no label, specify "No Label" or "NL".

**ENROLLMENT READERS FOR SCHLAGE EXPRESS**

Magstripe enrollment reader for Schlage Express	CRM2	\$877.00
---	------	----------

ENROLLMENT READERS

USB Enrollment reader - Multi-technology, Smart and Proximity Credentials	MT20	\$788.00
---	------	----------

USB / WIFI Enrollment, Read-write reader - Smart credentials only	MT20W	\$788.00
---	-------	----------

SCRAMBLE KEYPADS

Scramble keypad (Gray) - The keypad is designed to prevent onlookers from detecting the code being entered. Each key is lighted by an LED with a different set of numbers every time the keypad is used. Weatherized for outdoor applications with a Wiegand output. Power requirements: 8-14 VDC. Standard color is gray. Also available in black (SERIII-W-BLK).	SERIII-W-GR	\$2,758.00
---	-------------	------------

Scramble keypad surface mount kit (Gray) - Surface Mount Kit and tamper proof screws. Standard color is gray. Also available in black (SMK-2-BLK).	SMK-2-GR	\$359.00
---	----------	----------

Scramble keypad surface mount kit (ADA Compliant) - Surface Mount Kit and tamper proof screws. ADA compliant.	SSMK-2-ADA	\$690.00
--	------------	----------

Panel mount kit (Gray) - Standard color is gray. Also available in black (PMK-2-BLK).	PMK-2-GR	\$290.00
--	----------	----------

Panel mount kit with steel back box (Gray) - Steel back box with tamper proof screws. Standard color is gray. Also available in black (SPMK-2-BLK).	SPMK-2-GR	\$315.00
--	-----------	----------

Note: Mounting kits are sold separately and required for usage with scramble keypads.

ELECTRONIC KEYPADS

Electronic keypad (Mullion mount) - Stainless faceplate with keypad. Weatherized for outdoor use - 2x6 Matrix (5 or 12 VDC), Wiegand output.	SEKPDMWG	\$725.00
---	----------	----------

Electronic keypad - Stainless faceplate with keypad. Weatherized for outdoor use - 3x4 Matrix (5 or 12 VDC), Wiegand output.	SEKPDWG	\$1,052.00
---	---------	------------

Electronic keypad - Stainless faceplate with keypad. Weatherized for outdoor use - 3x4 Matrix (5 or 12 VDC), Wiegand output, 8 bit word.	SEKPD8B	\$1,028.00
---	---------	------------

OEM MODULE

OEM200 Module - The OEM200 module can be embedded into third-party products so that solution providers can seamlessly support RFID technology as part of their offering.	OEM200-TTL	\$212.00
---	------------	----------

OEM200 80mm Antenna Multi-Tech	47259227	\$92.00
--------------------------------	----------	---------



The following command cards (configuration cards) can be used across the Schlage electronics portfolio of wall mount readers and electronic locks to change factory default settings. Similarly, customer-specific command cards can be ordered to update field devices with site-specific custom encryption keys.

To order Configuration Cards specify this on your purchase order: COMMAND CARD CE-xxx-xxx.

- For example, to order an “LED Flash Red” command card, specify “COMMAND CARD CE-401-001” on your PO.

KEYPAD SETTINGS		
Description	Specify	Price
Keypad format, 26A; Fixed Facility Code 55	CE-000-026	\$13.70
Keypad format, 4 Bit burst	CE-000-034	\$13.70
Keypad format, 8 Bit burst	CE-000-038	\$13.70
Keypad format configuration mode	CE-000-044	\$13.70
Keypad backlight off	CE-000-045	\$13.70
Keypad backlight on	CE-000-046	\$13.70

AUDIO VISUAL SETTINGS		
Description	Specify	Price
LED Flash Red	CE-401-001	\$13.70
LED Solid Red	CE-401-002	\$13.70
LED Flash Green	CE-401-020	\$13.70
LED Flash Amber	CE-401-021	\$13.70
LED Solid Red; Flash Green and No Beep	CE-401-131	\$13.70
LED Solid Red; Flash Green and Beep	CE-401-132	\$13.70
Beeper off success	CE-401-133	\$13.70
Beeper on success	CE-401-134	\$13.70
Beeper and Green LED on Success for 1.5 seconds	CE-401-135	\$13.70
Card anti-passback disabled	CE-401-136	\$13.70
Card anti-passback enabled	CE-401-137	\$13.70
LED, beeper, and keypad beeper always off	CE-401-138	\$13.70
Flash Green and Beep (Success) 300ms	CE-401-139	\$13.70
Disable all sound	CE-401-141	\$13.70
Enable all sound	CE-401-142	\$13.70
LED and Beeper always off - External control only	CE-ALL-OFF	\$13.70
Disable all prox card technologies	CE-401-101	\$13.70
Enable all prox card technologies	CE-401-102	\$13.70
Disable HID prox	CE-401-111	\$13.70
Enable HID prox	CE-401-053	\$13.70
Disable GE/CASI prox	CE-401-082	\$13.70
Enable GE/ CASI prox 4001	CE-401-013	\$13.70
Enable GE/CASI prox 4002	CE-401-028	\$13.70
Enable AWID prox	CE-401-037	\$13.70
Disable AWID prox	CE-401-038	\$13.70
Enable prox report delay 0.8 seconds	CE-401-039	\$13.70
Disable prox report delay	CE-401-040	\$13.70

**CARD SERIAL NUMBER (CSN) OR UNIQUE IDENTIFIER (UID) SETTINGS**

Description	Specify	Price
CSN Reader 56 Bit; Prox enabled (formerly CE-001-201)	CE-004-201	\$13.70
CSN Reader; 32 (Special iClass All Significant Bits) (formerly CE-001-202)	CE-004-202	\$13.70
CSN Reader; 32 Bit (15693/iClass/inside MSB First) (formerly CE-001-203)	CE-004-203	\$13.70
CSN Reader; 32 Bit (15693/iClass/inside LSB First) (formerly CE-001-204)	CE-004-204	\$13.70
CSN Reader; 34 Bit (32 Mifare + 2 Parity) (formerly CE-001-205)	CE-004-205	\$13.70
CSN Reader; 40 Bit (32 Mifare + 8 bit LRC) (formerly CE-001-206)	CE-004-206	\$13.70
CSN Reader; 32 Bit (Mifare MSB First) (formerly CE-001-207)	CE-004-207	\$13.70
CSN Reader; 32 Bit (Mifare LSB First) (formerly CE-001-208)	CE-004-208	\$13.70
CSN Reader; 26 Bit (formerly CE-001-209)	CE-004-209	\$13.70
CSN Reader; 64 Bit (GE 6400) (formerly CE-001-210)	CE-004-210	\$13.70
CSN Reader; 55 Bit (GE 5502) (formerly CE-001-211)	CE-004-211	\$13.70
CSN Reader; 40 Bit (GE 4001) (formerly CE-001-212)	CE-004-212	\$13.70
CSN Reader; iClass and ISO15693 (5502), ISO14443A and GE Prox (4002)	CE-004-213	\$13.70
CSN Reader; MFC and EV1 56 bit, All prox off	CE-004-214	\$13.70
CSN Reader 64 bit reversed	CE-004-215	\$13.70
Felica CSN 64 bit reversed	CE-401-226	\$13.70

SMART CARD SETTINGS

Description	Specify	Price
Disable all smart card technologies (formerly CE-401-022)	CE-404-022	\$13.70
Enable all smart card technologies (formerly CE-401-023)	CE-404-023	\$13.70
Disable iClass CSN	CE-401-012	\$13.70
Enable iClass CSN 40 bit	CE-401-084	\$13.70
Enable iClass CSN 32 All Significant bits	CE-401-085	\$13.70
Enable iClass CSN 32 bit LSB first	CE-401-086	\$13.70
Enable iClass SE (AD Only)	CE-401-087	\$13.70
Disable iClass SE (AD Only)	CE-401-088	\$13.70
Enable iClass CSN 64 bit	CE-401-089	\$13.70
Enable CSN; Disable Secure MIFARE Classic, MIFARE DESFire EV1, EV3, and PIV (formerly CE-401-033)	CE-404-033	\$13.70
Enable Secure MIFARE Classic	CE-401-016	\$13.70
Enable Secure MIFARE DESFire EV1 and EV3	CE-401-018	\$13.70
Disable Secure MIFARE DESFire EV1 and EV3	CE-401-019	\$13.70
Disable MIFARE Plus	CE-401-042	\$13.70
Enable MIFARE Plus	CE-401-048	\$13.70
Disable MIFARE Classic	CE-401-049	\$13.70
Enable Felica CSN	CE-401-090	\$13.70
Disable Felica CSN	CE-401-091	\$13.70

PIV SETTINGS

Description	Specify	Price
Disable PIV	CE-401-000	\$13.70
Enable PIV; 75 Bit; Prox Off; Mifare Off, EV1 Off (formerly CE-401-176)	CE-404-176	\$13.70
Enable PIV; 200 Bit; Prox Off; Mifare Off, EV1 Off (formerly CE-401-177)	CE-404-177	\$13.70
Enable PIV; 75 Bit;	CE-401-075	\$13.70
Enable PIV; 58 Bit TWIC/CAC	CE-401-180	\$13.70
Enable PIV; 200 Bit FASC-N	CE-401-200	\$13.70
Enable PIV; 200 Bit FASC-N, All Else Off	CE-401-201	\$13.70



PIV SETTINGS		
Description	Specify	Price
Enable PIV; 64 Bit (BCD) TWIC/CAC	CE-401-181	\$13.70
Enable PIV; 83 Bit TWIC/CAC	CE-401-182	\$13.70
Enable PIV; 66 Bit (58 + TSM) TWIC/CAC	CE-401-183	\$13.70
Enable PIV; 64 Bit (58 No Parity + TSM) TWIC/CAC	CE-401-184	\$13.70
Enable PIV; 91 Bit (83 + TSM) TWIC/CAC	CE-401-185	\$13.70
Enable PIV; 40 Bit BCD	CE-401-186	\$13.70
Enable PIV; 40 Bit Reverse BCD	CE-401-187	\$13.70
Enable PIV; 64 Bit BCD	CE-401-188	\$13.70
Enable PIV; 64 Bit Reverse BCD	CE-401-189	\$13.70
Enable PIV; 128 Bit BCD	CE-401-190	\$13.70
Enable PIV; 128 Reverse BCD	CE-401-191	\$13.70
PIV-I GUID Sentinel enabled	CE-401-192	\$13.70
PIV-I GUID Sentinel disabled	CE-401-193	\$13.70
Enable PIV; 58 Bit HSE	CE-401-194	\$13.70

READER OUTPUT SETTINGS		
Description	Specify	Price
Enable Generic Clock & Data output	CE-401-050	\$13.70
Disable Clock & Data output, magstripe track 2	CE-401-051	\$13.70
Enable (9 Bit) Geoffrey MR5 Clock & Data emulation, magstripe track 2	CE-401-052	\$13.70
Enable Generic Clock & Data Output with 8 Leading 0 and 235 min bit length	CE-401-054	\$13.70
Enable Geoffrey MR5 Clock & Data emulation	CE-401-055	\$13.70
Enable PIM400-TD2 MR5 Clock & Data emulation	CE-401-056	\$13.70
Select magstripe track 1	CE-401-057	\$13.70
Select magstripe track 2	CE-401-058	\$13.70
Select magstripe track 3	CE-401-059	\$13.70
Enable POS Reader FAC Code UID Data Format	CE-401-060	\$13.70
Enable POS reader octal data format	CE-401-061	\$13.70
Enable CT5000 Clock & Data compatibility	CE-401-062	\$13.70
Set Wiegand Pulse Width = 48us; Separation = 2ms	CE-401-064	\$13.70
Set Wiegand Pulse Width = 40us; Separation = 2ms	CE-401-065	\$13.70
Set Wiegand Pulse Width = 100us; Separation = 1ms	CE-401-066	\$13.70
Enable Clock & Data H10301 26 bit	CE-401-067	\$13.70
Enable Clock & Data H10302 37 bit	CE-401-068	\$13.70
Enable POS reader badge ID only	CE-401-069	\$13.70
Select magstripe track 1 – raw data	CE-401-070	\$13.70
Select magstripe track 2 – raw data	CE-401-071	\$13.70
Select magstripe track 3 – raw data	CE-401-072	\$13.70
Enable Clock & Data conversion	CE-017-701	\$13.70
Enable POS reader hexadecimal data format	CE-401-073	\$13.70
Enable POS reader ID Only with USB keyboard prefix and suffix	CE-401-074	\$13.70
Point of sale output format =6	CE-401-076	\$13.70
Point of sale output format =7	CE-401-077	\$13.70
Point of sale output format =8	CE-401-078	\$13.70
MT20 Only – USB inter keystroke delay 0ms	CE-401-220	\$13.70
Card anti-passback (1.6 Seconds)	CE-401-140	\$13.70
MT20 Only – USB inter keystroke delay 5ms	CE-401-221	\$13.70

**READER OUTPUT SETTINGS**

Description	Specify	Price
MT20 Only – USB inter keystroke delay 10ms	CE-401-222	\$13.70
MT20 Only – USB inter keystroke delay 15ms	CE-401-223	\$13.70
MT20 Only – USB inter keystroke delay 20ms	CE-401-224	\$13.70
MT20 Only – USB inter keystroke delay 20ms and Point of Sale	CE-401-225	\$13.70
TRA Bit disabled	CE-401-230	\$13.70
TRA Bit enabled	CE-401-231	\$13.70
Mobile NFC bit disabled	CE-401-232	\$13.70
Mobile NFC bit enabled	CE-401-233	\$13.70
MT20 Only - Custom data decode format 26A	CE-401-234	\$13.70
MT20 Only - Custom data decode format 37X	CE-401-235	\$13.70
MT20 Only - Custom data decode format 40X	CE-401-236	\$13.70
MT20 Only - Custom data decode format 48X	CE-401-237	\$13.70
MT20 Only - Disable Felica, POS reader FAC Code UID data format, Custom data decode format 40X	CE-401-238	\$13.70

READER PERFORMANCE SETTINGS

Description	Specify	Price
MT20W Reset to Default	CE-000-040	\$13.70
MTB Reset to Default	CE-000-012	\$13.70
Disable BLE credential	CE-401-431	\$13.70
Enable BLE credential short range	CE-401-432	\$13.70
Enable BLE credential long range	CE-401-433	\$13.70
Disable BLE intent	CE-401-434	\$13.70
Enable BLE intent	CE-401-435	\$13.70
OSDP Baud rate 9600	CE-401-440	\$13.70
OSDP Baud rate 19200	CE-401-441	\$13.70
OSDP Baud rate 38400	CE-401-442	\$13.70
OSDP Baud rate 57600	CE-401-443	\$13.70
OSDP Baud rate 115200	CE-401-444	\$13.70
OSDP Baud rate 230400	CE-401-445	\$13.70
OSDP Baud rate 460800	CE-401-446	\$13.70
OSDP Address 0 (Default address for MT/B Series)	CE-401-447	\$13.70
OSDP Address 1	CE-401-448	\$13.70
OSDP Address 2	CE-401-449	\$13.70
OSDP Address 3	CE-401-450	\$13.70
OSDP Address 4	CE-401-451	\$13.70
OSDP Address 5	CE-401-452	\$13.70
OSDP Address 6	CE-401-453	\$13.70
OSDP Address 7	CE-401-454	\$13.70
OSDP Address 8	CE-401-455	\$13.70

Contents

Reader controllers | Overview 35
 How to order.....36
Reader controllers 36
 RC Multi-technology reader controllers.....36
 RC Parts and accessories36
 CTE ENGAGE™ Single door controller 37
 WRI400 Outdoor wireless reader interface39

Customer service	Technical support	Inside sales
<ul style="list-style-type: none"> Order status Credit returns of non-defective products General sales questions 	<ul style="list-style-type: none"> Technical questions/issues Returns of defective products Repairs 	<ul style="list-style-type: none"> General sales questions Custom Artwork credentials CardTrax™ accounts
USA Email Requests to: Sales Support Contact information on Page 2. CAN Canada.CustomerService @allegion.com	USA Readers_Credentials_Biometrics_ TechProdSupport@allegion.com CAN Canada.TechServices @allegion.com	USA ElectronicInsideSales@allegion.com CAN Canada.CustomerService @allegion.com



HOW TO ORDER

Follow the steps below.

1. Choose your reader controller model

Specify the desired Schlage RC Multi-technology reader controller (RC11, RC15, or RCK15).

2. Choose your pigtail cable and length

On a separate line item, specify the desired pigtail cable and pigtail length. A pigtail is required for installation and is not included with the RC model.



Standard features

- Real time connectivity; local mode feature allows reader to function without a connection to the network
- Communication is secured using industry standard TLS 1.2 encryption
- Tamper detection via accelerometer senses any type of altering and prevents a security breach with the reader
- Three configurable inputs; Door Position (DPS), Request-to-Exit (REX), and Auxiliary (AUX)
- Reader controllers support 124 kHz proximity, 13.56MHz smart technology, 2.4 GHz Bluetooth and Near Field Communication (NPC)
- Commission via ENGAGE™ mobile app for reader updates and easy configuration

RC MULTI-TECHNOLOGY READER CONTROLLERS		
Power requirements: 10 - 13 VDC / PoE or PoE+ (IEEE802.3af, Class 0)		

Description	Specify	Price
Mullion mount, dimensions: 5.94" x 1.77" x 1.0"	RC11	\$1,332.00
Wall mount, dimensions: 5.13" x 3.25" x 1.0"	RC15	\$1,332.00
Wall mount with keypad, dimensions: 5.13" x 3.25" x 1.0"	RCK15	\$1,518.00

RC PIGTAIL CABLES		
Description	Specify	Price
Pigtail cable - 10'	47274561	\$49.00
Pigtail cable - 25'	47274562	\$71.00

RC ACCESSORIES		
Description	Specify	Price
RC04 to SRC adapter cable	47609539	\$24.00
Advanced secure module - Exterior door kit (was 47317537)	ACC-EDK-3A	\$88.00
Magnetic lock kit - In rush suppressor (was 47317538)	ACC-IRS-4700	\$40.30
Back EMF DIODE assembly (was ACC-BACKEMF-DIODE)	47275384	\$7.40

RC COVERS		
Description	Specify	Price
Cover, wall mount - Black	47317539	\$29.20
Cover, wall mount with keypad - Black	47317540	\$29.20
Cover, mullion - Black	47317541	\$29.20

RC SCREW PACK		
Description	Specify	Price
Screw pack	47274844	\$14.00

The CTE is an ENGAGE™ enabled single opening controller that allows perimeter and common area openings to be managed in a single system along with Schlage Control® smart deadbolts, NDEB cylindrical, and LEB mortise wireless locks. It is ideal for multi-family, commercial mixed use, and retail store front applications.

The CTE is designed to work with a Schlage® Mobile enabled multi-technology reader and interface with an electrified lock, electromagnetic lock, electric strike, automatic operator or exit device to control an opening.

The CTE ENGAGE™ Single door controller with mobile enabled multi-technology reader kit can be used in a variety of applications; below are a few examples.

Please note: all components are sold separately.

ENGAGE™ cloud via mobile device or Wi-Fi, or Software Alliance Member (SAM) via Wi-Fi or GWE with IP to host

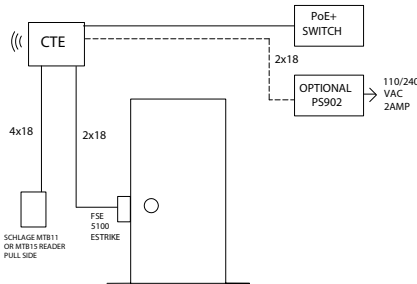

Operation: Presenting a valid credential to Schlage MTB XX reader will cause fail secure 5100 electric strike to release for authorized entrance. Free egress always.
Products: We offer a variety of electric strikes from Locknetics™ and Von Duprin®, as well as Schlage Power Supplies to meet the specific needs of the opening.

ENGAGE™ cloud via mobile device or Wi-Fi, or Software Alliance Member (SAM) via Wi-Fi or GWE with IP to host

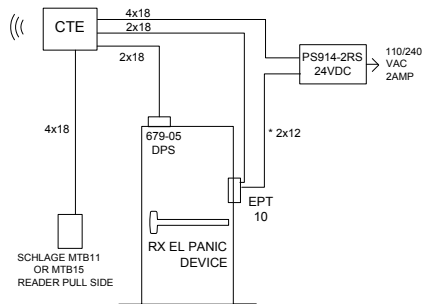

Operation: Presenting a valid credential to Schlage MTB XX will cause EL panic device to retract for authorized entrance. Free non-alarmed egress at all times.
Products: We offer a variety of Falcon® and Von Duprin exit devices, and Von Duprin power supplies to meet the specific needs of the opening.

ENGAGE™ cloud via mobile device or Wi-Fi, or Software Alliance Member (SAM) via Wi-Fi or GWE with IP to host

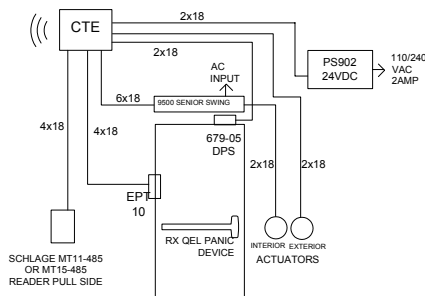

Operation: Presenting a valid credential to Schlage MTB XX will cause QEL panic device to retract for authorized entrance and enable exterior actuator. Free non-alarmed egress at all times. Interior actuator always active to retract QEL panic and open door.
Products: We offer a variety of hardware and accessories from Von Duprin, LCN®, Schlage and Locknetics to meet the specific needs of the opening.

Certifications: UL 294 Indoor, FCC Part 15, NEMA Enclosure Indoor (Type 1, 4, and 4X), ULC S319 Indoor, RoHS

How to order CTE Series

REQUIRED FIELDS

OPTIONS

CTE - MTB15 - B

1. CTE

2. Reader type

- MTB11 Mobile enabled multi-technology mullion mount
- MTB15 Mobile enabled multi-technology single gang wall mount

3. Cover Color (optional)

- B Black (standard)
- C Cream

CTE SERIES SINGLE DOOR CONTROLLER			
Description	Specify		Price
	Model No.	Color (optional)	
CTE with Mobile enabled multi-technology mullion reader kit	CTE-MTB11	- [B=Black; C=Cream]	\$1,539.00
CTE with Mobile enabled multi-technology single reader kit	CTE-MTB15	- [B=Black; C=Cream]	\$1,539.00

CT5000

The CT5000 is an indoor, offline single opening controller. It is flexible and works with various card reader technologies. With the correct power supply, the CT5000 controller works with various types of locking hardware, including electric strikes, electro-magnetic locks, or EL exit devices.

If networked functionality is required in the future, the CT5000 can be upgraded to a WRI-400 by upgrading the firmware and adding one incremental piece of hardware. This provides greater adaptability in the field.

Perimeter Door Application

The CT5000 can be used for perimeter door applications with an automatic operator, electric strike and card reader

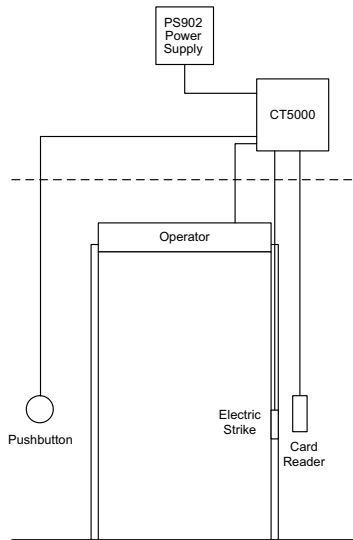

Narrow Stile Application

For narrow stile applications the CT5000 can be used with an electric strike and card reader

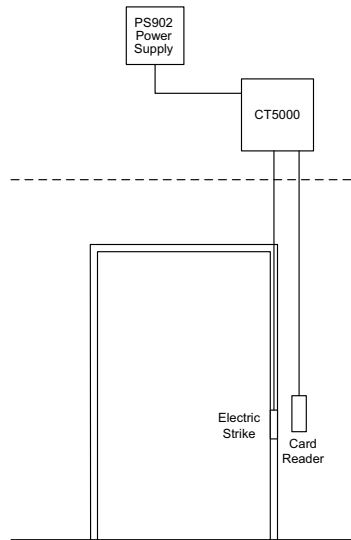

Panic Device Application

The CT5000 and a card reader along with the Von Duprin 914 Power Supply can control two EL exit devices for double door applications

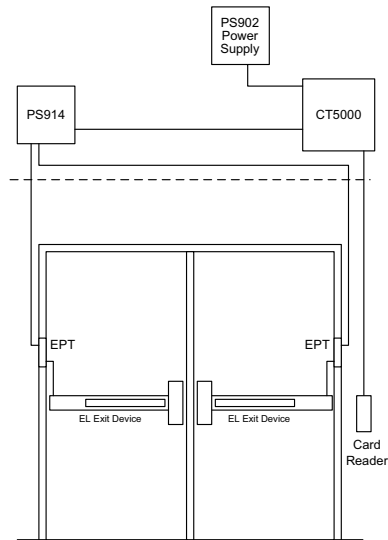

Note: All hardware shown above including exit devices, electric strikes, auto operators, power supplies, push buttons, etc. are sold separately.

Certifications

- UL 294
- Canada UL
- FCC Part 15
- Canada RSS – 210
- RoHS

Features

- Supports up to 5000 users and audits
- Comes standard with 15 foot USB remote cable connector
- Programmed using Schlage Handheld Device (HHD) via USB connection or with SUS A-KIT and Schlage Utility Software Android™ app
- Power is hardwired
- Three form C relay outputs (for strike, auxiliary, and alarm)
- Supports Request-to-Exit (remote release) and Door Position Switch input.
- Card functions supported: normal, toggle, freeze, pass through, construction, lock down, and all card plus PIN applications
- Multiple reader technologies and positions on both sides of the gate/ door
- Internal LED visual indicators (Including low battery and state of the relay)
- Compatible with Schlage Express

Credential compatibility

- Magnetic stripe: field configurable track 1, 2, or 3
- Compatible with Schlage, Xceed ID™, AWID®, HID®, GE/CASI ProxLite®
- 125 kHz Proximity cards: 26a, 34x, 35x, 37x bit formats (reader dependant)
- 13.56 MHz Smart card: 26a,34x, 35x, 37x, 40x, 48x bit format (reader dependant)
- Can read card serial number of Mifare DESfire (reader dependant)

The following readers are UL294 listed for use with the CT5000:

- Essex Electronics model KTP-162
- Mercury Security models MR-5 and MR-20
- Schlage (previously XceedID) models PR10, SM10, MT11, MT15, MTK15

CT5000 OFFLINE CONTROLLER		
Product ID	Product description	Price
CT5000	Offline controller (15 ft. USB cable standard)	See page 238
PS-902	2 Amp power supply (required)	See page 271
SUS A-KIT	Schlage utility software programming cable (required)	See page 175
23745565	125 ft. USB cable for CT5000 (optional)	See page 238
23703481	23703481 N N SL USB Wall plate with panel mount cable	\$89.80
23787088	23787088 N N SL CT5000 - 5 M USB extension cable - a female to a male	\$56.00

WIRELESS READER INTERFACE - (OUTDOOR)			
Product ID	Product description	Product specification	Price
WRI400	Outdoor wireless reader interface	Compatible with Wiegand or Clock & Data. Includes weatherproof enclosure, inputs for two parallel readers. Requires 12 or 24 VDC power supply.	\$1,280.00

Contents

Schlage Control® Mobile enabled smart interconnect locks 41

- Standard features.....41
- Specifications41
- Configure a product.....42
- Latch43
- Handing.....43
- Deco trim43
- Strike combinations43
- Deadbolt strike options.....43
- Deadlatch strike options.....43

Schlage Control® Mobile enabled smart deadbolt 44

- Standard features.....44
- Specifications44
- Configure a product.....44
- Latch45
- BE467F Strike options.....45
- Thick door kit.....45
- Screw packs.....45

Multi-family electronic locking systems 46

- Schlage Control® Smart locks.....46
- Schlage Smart credential.....46
- Multi-tech technology credentials46
- Credential enrollment reader.....46

Finish codes and descriptions

BHMA code	Description
619	Satin nickel
622	Matte black
625	Bright chromium plated
626	Satin chrome
716	Aged bronze

* Non-Standard finishes are not available. Available in split finish and/or split lever options for no additional charge.

Customer service	Technical support
<ul style="list-style-type: none"> ▪ Order status ▪ Credit returns of non-defective products ▪ General sales questions <p>USA Allegion_Orders@allegion.com CAN Canada.CustomerService@allegion.com</p>	<ul style="list-style-type: none"> ▪ Technical questions/issues ▪ Returns of defective products ▪ Repairs <p>USA Electronic_Lock_TechProdSupport@allegion.com CAN Canada.TechServices@allegion.com</p>



FE410 with Greenwich trim with Broadway lever



FE410 with Addison trim with Accent lever

Standard features

- Keyless, no cylinder design — 100% bump and pick-proof
- Modern credentials — smart credential and/or phone as key
- Wireless freedom — control and program by phone
- Up to 500 users per lock
- Audit trail reports up to 1,000 events
- Fits standard door prep
- 1 year battery life with BLE mobile credential capability enabled
- 1.5 year battery life without BLE mobile credential capability enabled

- Full suiting with Schlage mechanical locks
- Single motion egress
- ADA compliant design
- Uses ENGAGE™ Technology
- See page 46 for information on the MT20W Credential enrollment reader



Specifications

Latch	1" x 2-1/4" square and round corner faceplate (square corner standard, round corner included in package) 1" edge bore required	Stile width	Minimum 4-1/2" stile for 2-3/8" backset, minimum 5" stile for 2-3/4"
Strike	1-1/8" x 2-3/4", square corner, no box, latch strike	Return to door	Saturn (SAT), Neptune (NEP), Boardwalk (BRK), and Longitude (LON) are return to door code compliant
Backset	Adjustable backset, fits 2-3/8" to 2-3/4" backsets	Center to center	Fits 4" or 5-1/2" center to center door preps -orderable options (Please specify when ordering.)
Door range	1-3/8" to 1-3/4" (thick door kit available - up to 2")	Certifications	90-minute UL Listed A 156.36 Grade 2 ANSI/BHMA certified; Canada UL 20-minute wood door rated. Approved for use where the exterior escutcheon only is exposed to the outdoors.
Battery	4-AA batteries included, (If loss of battery power occurs, a 9V battery can be used to jump start the lock and provide access with an assigned credential.)		
Construction	All-metal chassis and escutcheons		
Bore	2-1/8"		
Credentials	Supports Schlage MIFARE Classic®, Schlage MIFARE® Plus®, Schlage Mobile Access Credential, Schlage DESFire® EV1 and Schlage DESFire® EV3 (sold separately). Please refer to the Credential Section of the Allegion Electronic Security Price Book.		



SCHLAGE CONTROL® MOBILE ENABLED SMART INTERCONNECT LOCK

1. SELECT LOCK MODEL

Description	Specify	Price (ea.)
Schlage Control® Mobile enabled smart interconnect, UL Listed, 90 minutes	FE410F	\$950.00

2. SELECT DESIGN STYLE (TRIM)

Description	Specify	Price adjustment
Addison	ADD	No charge
Greenwich	GRW	No charge

3. SELECT INTERCONNECT TYPE

Description	Specify	Price adjustment
For doors with 4" bore hole spacing (40)	4"	No charge
For doors with 5-1/2" bore hole spacing (55)	5-1/2"	No charge

4. SELECT FINISH STYLE

Description	Specify	Price adjustment
Satin Nickel	619	No charge
Matte Black	622	No charge
Bright Chrome	625	No charge
Satin Chrome	626	No charge
Aged Bronze	716	No charge

4. DESIGN - SELECT LEVER STYLE AND FINISH

Style / Description	619	622	625	626	716
ACC / Accent	■	■	■	■	■
VLA / Avila	■		■	■	■
BRW / Broadway	■	■	■	■	■
BRK / Boardwalk	■	■	■	■	■
ELA / Elan	■	■	■	■	■
JAZ / Jazz	■	■	■	■	■
JUP / Jupiter	■	■	■	■	■
LAT / Latitude	■	■	■	■	■
LON / Longitude	■	■	■	■	■
MNH / Manhattan	■		■	■	
NEP / Neptune	■	■	■	■	■
NBK / Northbrook	■				
SAC / Sacramento	■		■	■	■
SAT / Saturn	■	■	■	■	■

CREDENTIALS
READERS
READER CONTROLLERS
MULTI-FAMILY
ENGAGE
AD SERIES
CO SERIES
ELECTROMAGNETIC LOCKS
POWER SUPPLIES
VON DUPRIN ACCESS CONTROL
SYSTEM ACC
MISC



LATCH		
Description	Specify	Price (ea.)
Standard - Combo latch, Dual option (sq + rd), Non UL bolt, UL latch	12-356	Not sold separately

HANDING		
Description	Specify	Price (ea.)
Standard - Can be changed to Right handed in the field	Left	No charge

DECO TRIM		
Description	Specify	Price (ea.)
Standard - ADD or GRW depending on which style is selected above	06-219	No charge

STRIKE COMBINATIONS		
Description	Specify	Price (ea.)
Standard - Combo strike, square corner (10-094 and 10-026)	10-152	No charge
10-094 and 10-001	10-151	No charge
10-081 and 10-001	10-119	No charge
10-116 and 10-027	10-122	No charge
10-092 and 10-027	10-123	No charge
10-095 and 10-027	10-124	No charge

DEADBOLT STRIKE OPTIONS		
Description	Specify	Price (ea.)
Standard - Square corner strike, 1-1/8" x 2-3/4"	10-094	\$17.00
1/4" Radius round corner, full lip, no box, 1-5/8" x 2-1/4"	10-092	\$11.00
Square corner, full lip, no box, 1-5/8" x 2-1/4"	10-095	\$11.00
Metal dust box with screws	10-112	\$17.00

DEADLATCH STRIKE OPTIONS		
Description	Specify	Price (ea.)
Standard - Square corner, full lip, no box, 1-5/8" x 2-1/4"	10-026	\$10.60
Square corner, T-strike, box, 1-1/8" x 2-3/4"	10-001	\$9.00
1/4" Radius round corner, full lip, no box, 1-5/8" x 2-1/4"	10-027	\$10.60

THICK DOOR KIT		
Description	Specify	Price (ea.)
For doors between 1-3/4" and 2"	47244555	\$33.00

The Schlage Control® interconnect lock uses the same Thick Door Kit as the deadbolt. However, due to the latch assembly it should only be used on doors between 1-3/4" and 2".

SCREW PACKS	Available finishes										
	605	606	612	613	619	622	625	626	629	630	716
	N/A	N/A	N/A	N/A	▪	▪	▪	▪	N/A	N/A	▪
Description	Specify										Price (ea.)
	Part number		Finish								
Security screws - Optional security Torx® screws	47250323		.[Finish]								\$10.00
FE410 Screw pack	47275372		.[Finish]								\$10.00



BE467 Greenwich (GRW)



BE467 Addison (ADD)

PRODUCT IDENTIFICATION		
BE	467	F
Lock	Function	90 Minute UL



Standard features

- Keyless, no cylinder design — 100% bump and pick-proof
- Modern credentials — smart credential and/or phone as key
- Wireless freedom — control and program by phone
- Up to 500 users per lock
- Audit trail reports up to 1,000 events
- Fits standard door prep
- 1 year battery life with BLE mobile credential capability enabled
- 1.5 year battery life without BLE mobile credential capability enabled
- Full suiting with Schlage decorative mechanical locks
- ADA compliant design
- Uses ENGAGE™ Technology
- See page 46 for information on the MT20W Credential enrollment reader

Specifications

Latch	1" x 2-1/4" square and round corner faceplate (round corner standard, square corner included in package) 1" edge bore required	Bore	2-1/8"
Strikes	1-1/8" x 2-3/4", round corner, no box, latch strike	Credentials	Supports Schlage MIFARE Classic®, Schlage MIFARE® Plus®, Schlage Mobile Access Credential, Schlage DESFire® EV1 and Schlage DESFire® EV3 (sold separately). Please refer to the Credential Section of the Allegion Electronic Security Price Book.
Backset	Adjustable backset, fits 2-3/8" to 2-3/4" backsets	Stile width	Minimum 4-1/2" stile for 2-3/8" backset minimum 5" stile for 2-3/4"
Door range	1-3/8" to 1-3/4" (thick door kit available - up to 2-1/4")	Certifications	90-minute UL Listed A 156.36 Grade 2 ANSI/BHMA certified; Canada UL 20-minute wood door rated. Approved for use where the exterior escutcheon only is exposed to the outdoors.
Hole distance	Minimum 4" center-to-center distance between cross bore holes		
Battery	4-AA batteries included, (If loss of battery power occurs, a 9V battery can be used to jump start the lock and provide access with an assigned credential.)		
Construction	All-metal chassis and escutcheons		

1. SELECT LOCK MODEL		
Description	Specify	Price (ea.)
Schlage Control® Mobile enabled smart deadbolt, UL Listed, 90 minutes	BE467F	\$642.00

2. SELECT DESIGN STYLE (TRIM)		
Description	Specify	Price adjustment
Addison	ADD	No charge
Greenwich	GRW	No charge

3. SELECT FINISH STYLE		
Description	Specify	Price adjustment
Satin Nickel	619	No charge
Matte Black	622	No charge
Bright Chrome	625	No charge
Satin Chrome	626	No charge
Aged Bronze	716	No charge



LATCH		
Description	Specify	Price (ea.)
Standard - BE467F 90 Min UL Deadbolt latch dual option (sq+rd)	12-398	Not sold separately

BE467F STRIKE OPTIONS		
Description	Specify	Price adjustment
Standard - Round corner strike, 1-1/8" x 2-3/4"	10-116	No charge
Square corner strike, 1-1/8" x 2-3/4"	10-094	No charge
Square corner full lip strike, 1-5/8" x 2-1/4" (Lip length: 1-1/8")	10-095	No charge
Round corner full lip strike, 1-5/8" x 2-1/4" (Lip length: 1-1/8")	10-092	No charge

THICK DOOR KIT		
Description	Specify	Price (ea.)
For doors between 1-3/4" and 2-1/4"	47244555	\$33.00

The Schlage Control® deadbolt uses the same Thick Door Kit as the Interconnect. However, due to the differences in latch assemblies, the deadbolt can accommodate doors up to 2-1/4" in thickness.

SCREW PACKS	Available finishes										
	605	606	612	613	619	622	625	626	629	630	716
	N/A	N/A	N/A	N/A	▪	▪	▪	▪	N/A	N/A	▪
Description	Specify		Price (ea.)								
	Part number	Finish									
Security screws - Optional security Torx® screws	47250323	.[Finish]	\$10.00								
FE410 Screw pack	47275372	.[Finish]	\$10.00								



Greenwich (GRW)

Addison (ADD)

SCHLAGE CONTROL® SMART LOCKS - TOP SELLERS					
Product	BHMA Finish	Latch	Strike	Lever Style	Price (ea.)
BE467F GRW	619	12-398	10-116	N/A	\$642.00
BE467F GRW	626	12-398	10-116	N/A	\$642.00
BE467F ADD	619	12-398	10-116	N/A	\$642.00
BE467F ADD	626	12-398	10-116	N/A	\$642.00
FE410F GRW	619	12-356	10-152	Latitude	\$950.00
FE410F GRW	626	12-356	10-152	Latitude	\$950.00
FE410F ADD	619	12-356	10-152	Latitude	\$950.00
FE410F ADD	626	12-356	10-152	Latitude	\$950.00

Note: FE410 locks are 5.5" center-to-center.

SCHLAGE SMART CREDENTIALS				
Product	Type	Description	Min. Order	Price (ea.)
9651	Keyfob	Schlage MIFARE Classic Smart Card 1K bit keyfob	50	\$10.10
9651T	Thin keyfob	Schlage MIFARE Classic Smart Card 1K bit thin keyfob	50	\$10.30
8540	Card	Schlage MIFARE DESFire EV1 Smart Card 2K byte / 16k bit ISO Glossy White	100	\$10.40
8543	Card	Schlage MIFARE DESFire EV3 4K byte/32K bit ISO Glossy White	100	\$10.40
8643T	Thin keyfob	Schlage MIFARE DESFire EV3 4K/32K bit thin keyfob	50	\$10.80

Note: 125 kHz Proximity credentials and MIFARE DESFIRE EV2 credentials are not compatible.

MULTI-TECH TECHNOLOGY CREDENTIALS				
Product	Type	Description	Min. Order	Price (ea.)
9691T	Thin keyfob	Proximity and Schlage MIFARE Classic Smart Card combo 1K byte/8K bit ISO thin keyfob	50	\$13.60
8843T	Thin keyfob	Proximity and Schlage MIFARE DESFire EV3 4K byte/32K bit thin keyfob	100	\$16.30

CREDENTIAL ENROLLMENT READER		
Product	Description	Price (ea.)
MT20W	Schlage Credential enrollment reader	\$788.00

LE MOBILE ENABLED WIRELESS LOCK

Grade 1 mortise levered lock

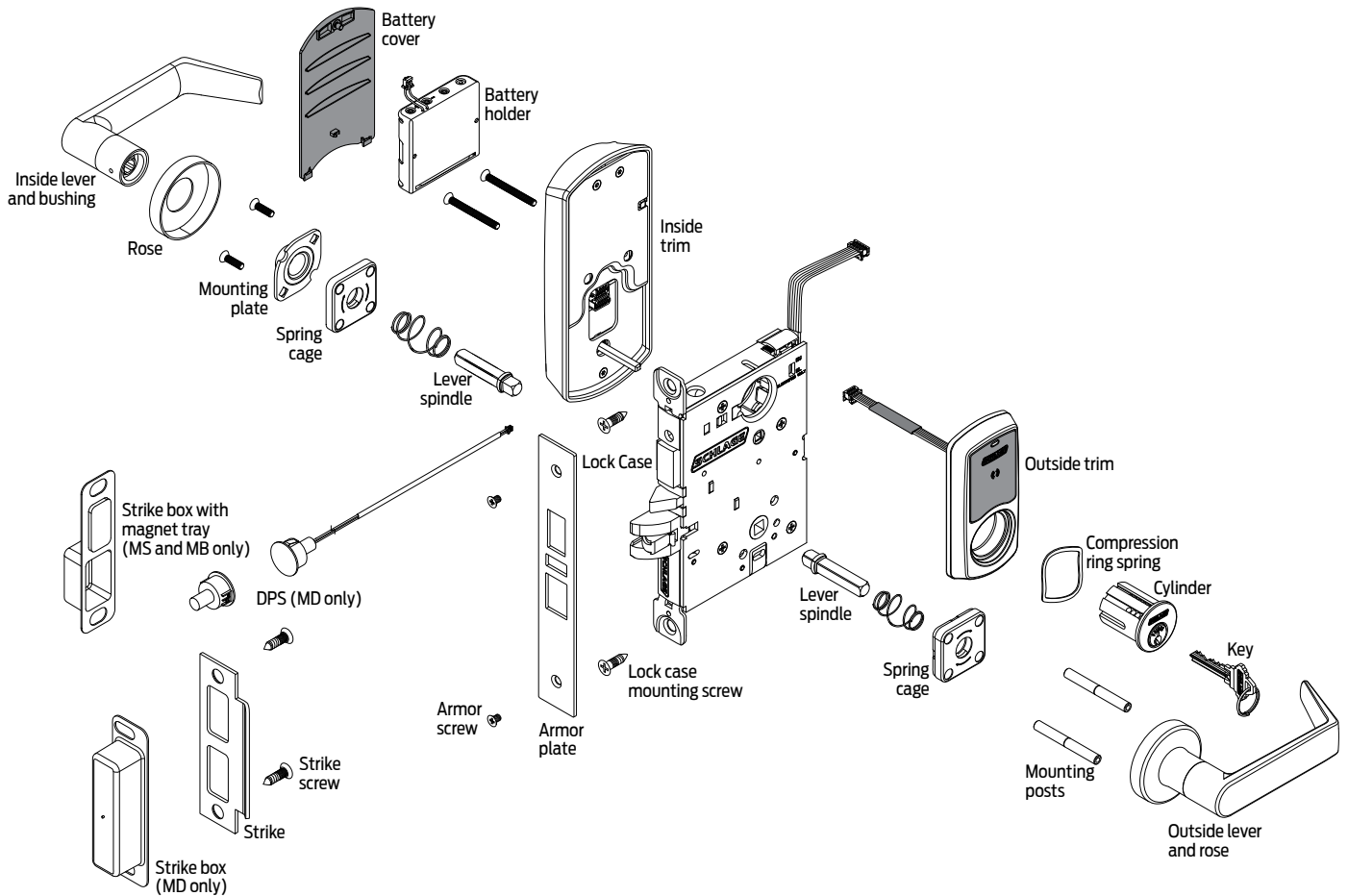

Contents

LE Lock Overview.....	47
How to order.....	49
LE Lock Functions.....	51
LE Lock Styles	52
LE Lock Configure a product	56
Cylinders.....	57
Greenwich mortise/mortise deadbolt.....	58
Addison mortise/mortise deadbolt.....	60
LE Lock Parts.....	62
Levers.....	62
Roses	62
Inside/outside subassemblies.....	63
Battery parts and components	64
Armor fronts.....	64
Strikes.....	64
Mortise cylinders.....	64
Cylinder housing without core.....	65
Chassis and wire harnesses.....	65
Lever/knob parts and components.....	65
Screws.....	66
Screw packs.....	66
LE Lock Accessories	67

Finish codes and descriptions

BHMA code	Description
605	Bright brass
606	Satin brass
612	Satin bronze
619	Satin nickel
622	Matte black
625	Bright chromium plated
626	Satin chrome
626AM	Satin stainless steel, antimicrobial
643e	Aged bronze

Standard features



Certification	ANSI/BHMA Certified A156.25-2013 (Indoor/Outdoor), ANSI/BHMA Certified A156.13-2012, Series 1000, Grade 1 UL 294, ULC S319, UL 10C 3-hour rated
Case size	4-7/16" x 6-1/16" x 1"
Armor front	1-1/4" x 8"
Deadbolt	1" throw stainless steel
Latch bolt	3/4" throw stainless steel with anti-friction tongue
Strike	1-1/4" x 4-7/8", square corner, 1-3/16" lip with box and DPS
Backset	2-3/4"
Cylinder	6-pin solid brass, keyed 6-pin, S123 keyway, keyed different (KD)
Door range	1-3/4" door thickness standard (can be ordered to accommodate doors 1-3/4" to 2-1/4" thick)
Keys	Two nickel silver cut keys per lock, 6-pin, S123 section

How to order LE Lock

REQUIRED FIELDS				FACTORY DEFAULT AND OPTIONS										
LEB	MS	GRW	P6	03	626	00A	-	612	-	LH	10-136	134	S123	-

1. Series														
LEB	Mobile enabled mortise lock													
LEBSI	Mobile enabled mortise lock with HID Credential secure sector compatibility													
2. Chassis/function														
MS	Mortise with LED indicator													
MB	Mortise with push button and LED													
MD	Mortise Deadbolt with LED													
3. Style														
GRW	Greenwich sectional with rose													
ADD	Addison escutcheon													
4. Cylinder type														
P6	Mortise cylinder, Schlage 6-pin													
For all options see LE ordering pages														
5. Outside lever¹														
03	Suites with Tubular style													
LAT	Latitude													
For all options see LE ordering pages														
¹ To add tactile warning, use prefix 8. Example: 803														
6. Outside finish														
605	Bright Brass	622	Matte Black											
606	Satin Brass	625	Bright Chrome											
612	Satin Bronze	626	Satin Chrome											
619	Satin Nickel	643e	Aged Bronze											
626AM	Satin Chrome (Antimicrobial Coating)													
7. Outside rose (specify only for Greenwich trim)														
00A	2-1/8" (54 mm) diameter (Std.)													
00B	2-9/16" (65 mm) diameter													
00C	2-5/8" (66 mm) diameter with bevel													
AVA	Decorative rose 2-5/8" (66 mm) diameter, supports ACC lever only													
MER	Decorative rose 2-5/8" (66 mm) diameter, supports MER lever only													
8. Inside lever (specify only if different from outside lever)														
3	Suites with Tubular style													
LAT	Latitude													
For all options see LE ordering pages														
9. Inside finish (specify only if different from outside finish)														
See options under 6 above														
10. Inside rose (specify only for Greenwich trim and only if different from Outside rose)														
See options under 7 above														
11. Handing														
RH	Right handed (Std.)	RHR	Right handed reverse											
LH	Left handed	LHR	Left handed reverse											
12. Strike plate lip length														
10-316	1-3/16" lip length (Std. for MS/MB)													
10-316-112	1-1/2" lip length													
For all options see LE ordering pages														
13. Door thickness														
134	1-3/4" (Std.)													
Options available up to 2-1/4" thickness - see LE ordering pages														
14. Keyway type														
S123	Everest 29 S (Std.)													
For all options see LE ordering pages														
15. Additional options														

Customer service	Technical support
<ul style="list-style-type: none"> Order status Credit returns of non-defective products General sales questions 	<ul style="list-style-type: none"> Technical questions/issues Returns of defective products Repairs
USA Allegion_Orders@allegion.com CAN Canada.CustomerService@allegion.com	USA Electronic_Lock_TechProdSupport@allegion.com CAN Canada.TechServices@allegion.com

Common pricing information	
1.	Locks are furnished with standard features unless otherwise specified.
2.	Door thickness is 1-3/4".
3.	Split finishes and designs will be priced at the highest list price of the design and/or finish.
4.	Engineering specials are denoted by a part number beginning with "X" and are not subject to standard discounting.
5.	⌚ denotes a lock or part that requires an extended lead time.
6.	↔ denotes a handed product and requires handing to be specified.
7.	For all restricted keyways (Everest B, D, 29R, and 29T, also Quad, Numbered, and Reversed) add \$30.00. This does not apply to Primus cylinders. See page 4 for ordering information and requirements.
8.	Locks, keys, and cylinders containing restricted keyways require additional documentation to order. Please see page 4 for the specific requirements.
9.	Keyway must be specified for keyed functions and cylinders. If not specified, default keyway will be S123 for KA (keyed alike), KD (keyed different), and O-bitted product and S145 for factory managed masterkey systems.
10.	Multiple keying options are available. Locks and cylinders are furnished KD unless otherwise specified or excepted by notation.
11.	Control Keys for permanent and construction cores are not included with the lock or cylinder and must be ordered separately.
12.	Locks specified with "C" keyway and KD or O-bitted will receive 6-pin cylinders (keyed 5) with 5-pin keys.
13.	Full Size Interchangeable Cores (FSIC) are furnished 1-bitted unless otherwise specified. If O-bitted is selected, the order will be entered as 1-bitted. This does not apply to FSIC Primus® cores.
14.	Conventional cylinders, Primus cylinders (conventional and FSIC) can be supplied O-bitted. If 1-bitted is selected, the order will be entered as O-bitted.
15.	Available plug face finishes are 606, 622, 626 and 643e.

FUNCTIONS

ADDISON ESCUTCHEON SHOWN

LEBMS and LEBSIMS - Mortise with LED Indicator		
Storeroom/ Classroom	<p>Lockset is normally secure. Valid normal credential or key momentarily unlocks door. Valid toggle credential may be used to change to a passage or secured state. A mechanical key will retract the latch. An inside indicator LED confirms state of the lock. Inside lever always allows free egress.</p>	
LEBMB and LEBSIMB - Mortise with Interior Push Button and LED		
Office	<p>Lockset is normally secure. Valid normal credential or key momentarily unlocks door. Valid toggle credential may be used to change to a passage or secured state. Interior push button on inside housing can be used to select a passage or secured state and confirms state of the lock via LED indicator. A mechanical key will retract the latch. Inside lever always allows free egress. Meets the need for lockdown function for safety and security.</p>	
Privacy	<p>Lockset is normally secure. Valid normal credential or key momentarily unlocks door. Valid toggle credential may be used to change to a passage or secured state. Interior pushbutton on inside housing may be used to select a privacy status. The interior pushbutton will disable normal electronic access from the exterior and confirms state of the lock via LED indicator. Opening the door or pressing the interior pushbutton a second time on the inside housing deactivates the privacy status. A mechanical key will always retract the latch. Inside lever always allows free egress. Door position sensor required for function.</p>	
Apartment	<p>Lockset is normally secure. Valid normal or toggle credential is used to change to a passage or secured state. Interior pushbutton on inside housing may be used to select a passage or secured state and confirms state of the lock via LED indicator. Opening the door or pressing the interior pushbutton a second time causes the lockset to toggle to passage. While in passage mode, the lockset can only be secured while the door is closed by pressing the interior pushbutton or using a normal credential on the exterior. A mechanical key will retract the latch. Inside lever always allows free egress. Door position sensor required for function.</p>	
LEBMD and LEBSIMD - Mortise Deadbolt with LED		
Privacy	<p>Lockset is normally secure. Valid normal credential or key momentarily unlocks door. Valid toggle credential may be used to change to a passage or secured state. Thumbturn on inside housing may be used to select a privacy status. The thumbturn will disable normal electronic access from the exterior and confirms state of the lock via LED indicator. Opening the door or retracting the deadbolt deactivates the privacy status. A mechanical key will always retract the latch. Inside lever always allows free egress. Door position sensor required for function.</p>	
Apartment	<p>Lockset is normally secure. Valid normal or toggle credential is used to change to a passage or secured state. Thumbturn on inside housing may be used to select a passage or secured state and confirms state of the lock via LED indicator. Opening the door or retracting the deadbolt causes the lockset to toggle to passage. While in passage mode, the lockset can only be secured while the door is closed by rotating thumbturn or using a normal credential on the exterior. A mechanical key will retract the latch. Inside lever always allows free egress. Door position sensor required for function.</p>	

Handing		
RH	Right handed: Hinges on right opens inward	
LH	Left handed: Hinges on left opens inward	
RHR	Right handed reverse: Hinges on right opens outward	
LHR	Left handed reverse: Hinges on left opens outward	

LE LOCK

NDE LOCK

STANDARD LEVER COLLECTION

01

2 11/16" | 2 1/16" | 3 7/8"

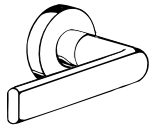

02

2 13/16" | 1 13/16" | 4 3/4"

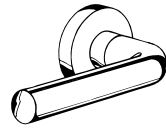

03 (TUBULAR)

2" | 2 13/16" | 1/2" | 4 3/4" | Dia. 1 1/16"

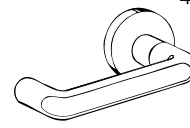

05

2 7/8" | 2 9/32" | 3 3/4"

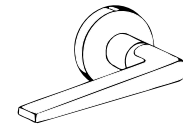

06 (RHODES)

2 1/2" | 2" | 1/2" | 4 5/8"

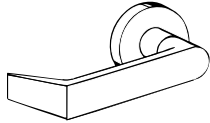

07 (ATHENS)

2 7/8" | 2 3/8" | 1 31/32" | 4 5/8"



12
Handing required

3 1/16" max. | 2" | 4 5/8"



17 (SPARTA)

2 15/16" | 3" | 1/2" | 4 3/4"



18

2 11/16" | 2 1/32" | 4 7/8"

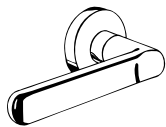

LATITUDE (LAT)

2 9/16" | 2" | 4 3/4"

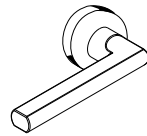

LONGITUDE (LON)

2 9/16" | 1/2" | 4 7/8"

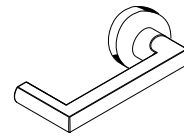

OMEGA (OME)

3 5/16" | 2 3/10" | 3/8" | 5 1/16"

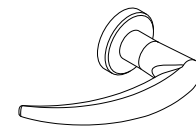

ACCENT (ACC)
Handing required

3 1/8" | 2" | 4 1/8"



ASTI (AST)
Handing required

2 5/8" | 2" | 4"



MERANO (MER)
Handing required

3 1/8" | 2" | 4"

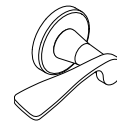

41

2 3/4" | 2 1/4"



42

2 3/4" | 2 1/8"

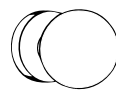

M LEVER COLLECTION

<p>M51</p>	<p>M52</p>	<p>M53</p>	<p>M54</p>
<p>M55</p>	<p>M56</p>	<p>M61 Handing required</p>	<p>M63 Handing required</p>
<p>M81</p>	<p>M82</p>	<p>M83</p>	<p>M84</p>
<p>M85 Handing required</p>	<p>ME1</p>	<p>ME2</p>	<p>ME3</p>

WROUGHT ROSE DESIGNS

00A

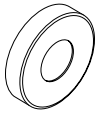

2 1/8" (54 mm) diameter

00B

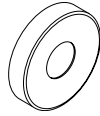

2 3/16" (65mm) diameter

00C

Not available in 612 finish



2 5/8" (66mm) diameter

AVA

ACC lever only



2 5/8" (66mm) diameter

MER

MER lever only



2 5/8" (66mm) diameter

WROUGHT ESCUTCHEON DESIGN

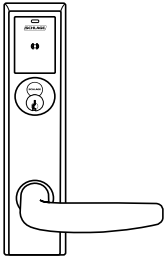

07 Lever shown

TACTILE OPTIONS

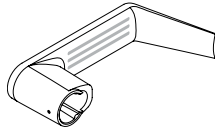

06 Lever shown
(See LE ordering pages for availability)

COMMERCIAL LEVER SUITING						
Standard Levers						
L /LE Mortise	LT Tubular	ND /NDE Cylindrical	AD/CO Series	AL Cylindrical	S Tubular	33A/35A, 94/95, 98/99 Exit devices (Von Duprin)
01	01	-	-	-	-	01
02	02	-	-	-	-	02
03	03	Tubular ¹	Tubular	-	-	03
05	05	-	-	-	-	05
06	06	Rhodes	Rhodes	Saturn	Saturn	06
07	07	Athens	Athens	Jupiter	Jupiter	07
12	12	-	-	-	-	12
17	17	Sparta	Sparta	Neptune	Neptune	17
18	18	-	-	-	-	18
Latitude	Latitude	Latitude	-	-	-	Latitude
Longitude	Longitude	Longitude	-	-	-	Longitude
Omega ¹	Omega	Omega ¹	-	Omega	-	16
Asti	Asti	-	-	-	Flair	Asti
Merano	Merano	-	-	-	-	Merano
Accent	Accent	-	-	-	-	Accent
M52 ¹	M52 ¹	Broadway	-	-	-	-
M81 ¹	M81 ¹	Boardwalk	-	-	-	-
M Collection Levers						
L /LE Mortise	LT Tubular	ND /NDE Cylindrical	AD/CO Series	AL Cylindrical	S Tubular	33A/35A, 94/95, 98/99 Exit devices (Von Duprin)
M51	M51	-	-	-	-	M51
M52	M52	-	-	-	-	M52
M53	M53	-	-	-	-	M53
M54	M54	-	-	-	-	M54
M55	M55	-	-	-	-	M55
M56	M56	-	-	-	-	M56
M57 ²	M57	-	-	-	-	M57
M61	M61	-	-	-	-	M61
M62 ²	M62	-	-	-	-	M62
M63	M63	-	-	-	-	M63
M81	M81	-	-	-	-	M81
M82	M82	-	-	-	-	M82
M83	M83	-	-	-	-	M83
M84	M84	-	-	-	-	M84
M85	M85	-	-	-	-	M85
ME1	ME1	-	-	-	-	ME1
ME2	ME2	-	-	-	-	ME2
ME3	ME3	-	-	-	-	ME3

1. Not available on NDE Series locks. M52 is equivalent to the Broadway lever and M81 to the Boardwalk lever.
 2. Not available on LE Series locks.

You can **configure and price a full range of products** using the tables and rules shown in this section.

The pricing of locks in this section includes the P6 cylinder in an open keyway (where applicable), default latch, strike, and a 1-3/4" thick door. Additional modifications are available using the rules and price adjustments on the subsequent pages.

How to order:

- All applicable product attributes must be provided in the order shown below
- Each value must be separated by a period
- If requesting a product "Less (LLL)" any attribute, the entire detailed ACN must be provided
- Fractions will be written with the "/" symbol separating the numerator and the denominator (example 1/2)
- For dimensions that contain a whole number and a fraction, a hyphen "-" will be added after the whole number and before the fraction (example 2-1/4)
- For two dimensions represented together, such as length and width, the values would be separated by an "x" with no spaces
- Finishes should be listed using their BHMA finish as shown in this book

Required for all lock orders																			
Quantity	Brand	Series + Chassis + Function	Style	Cylinder	Outside style			Inside style			Handing	Strike	Door dimensions			Options	Keying		
					Outside lever design	Outside rose design	Outside finish	Inside lever design	Inside rose design	Inside finish			Door thickness	Extended	Strike lip length		Keying code	Keyway	Pack keys independently
1	2	3	4	5A	5B	5C	6A	6B	6C	7	8	9A	9B	9C	10	11A	11B	11C	

Applicable only to Greenwich sectional with rose design

Specify only if different than outside style

Only required when deviating from the product's default. Specify only the deviated attribute(s).

Only required when deviating from the product's default. Specify only the deviated attribute(s).

Required if selecting one of the handed lever styles

If ordering a product "Less (LLL)" any attribute, values for each attribute must be provided.

EXAMPLE:

LEBMS . GRW . P6 . 03 . 00A . 626 . 12 . LH . DT2-1/4 . EE . KA0BIT . S123

2 3 4 5A 5B 5C 6A 7 9A 9B 11A 11B

Inside lever design different than outside

Deviating from the KD default requires keying to be specified

Thick door requires door thickness and extension to be specified

COMPLETE LOCKS

CYLINDERS

Keyed locks are priced including the P6 cylinder with open keyway. Provided below are pricing adjustments based on other available cylinder types. For Primus and Primus XP cylinders, order lock less cylinder and order the Primus or Primus XP cylinder separately.

P6, Z, L		R, J, T		G, B, H, BDC	
CYLINDER					
P6	With mortise cylinder, Schlage Everest 29 S123 6-pin Keyed different as standard with two keys For master keying, additional charge applies Specify line item 50-210 per master-keyed lock				
Z	With mortise cylinder, Schlage Everest SL 7-pin - factory master keyed only				
L	Less mortise cylinder				
R	With cylinder, Schlage Everest 29 S123 6-pin Full Size Interchangeable Core (FSIC) Keyway one bitted as standard with two keys				
J	Less cylinder, Schlage 6-pin FSIC				
T	T Construction core Full Size Interchangeable Core (FSIC)				
G	With cylinder, Schlage Everest 29 R 7-Pin Small Format Interchangeable Core (SFIC) Factory master keyed with two keys as standard, master keying must be specified				
B	Less cylinder Schlage, Falcon, Competitive OEM's 7-pin SFIC				
H	Construction core SFIC A non-refundable handling charge applies				
BDC	Disposable core SFIC				

1. For P, R, Z and GD, master keyed cylinders can be specified and will be shipped in lock packaging.
2. For Master Key System Summary form which should accompany the master keyed order, see pages 296–301.
3. Control Keys for installation/removal of interchangeable cores are not furnished and must be ordered separate.
4. For additional assistance on Master Keying as well as restricted keyways please contact your local sales representative.

CYLINDER AND LENGTH REQUIREMENTS				
Cylinder type	Cylinder	Door thickness (+/- 1/8")		
		1-3/4"	2"	2-1/4"
Mortise cylinder	30-021 ³	1-1/4" (114), 1-3/8" (138), 1-1/2" (112)	1-3/8" (138), 1-1/2" (112), 1-5/8" (158)	1-1/2" (112), 1-5/8" (158), 1-3/4" (134)
FSIC	30-016 ⁴	1-1/2" (112)		
SFIC	80-108 ⁴	1-3/8" (138)		N/A

1. 112 Standard length will ship with lock.
2. Product is Less Core, see page 65 for pricing.
3. Cylinders include compression spring.
4. Assumes EE (equally extended).
5. Door thickness range supported: minimum 1-5/8" to maximum 2-3/8".
6. Supports all functions (MS, MB, MD) for both ADD and GRW.

GREENWICH

LE MOBILE ENABLED WIRELESS LOCK

1-3. Select chassis/function/style
Price

Check with access control software partner or PACS provider to verify function and/or mobile enabled version is supported by software.		
LEBMS-GRW	Mobile enabled mortise with LED indicator: Storeroom function	\$1,763.00
LEBMB-GRW	Mobile enabled mortise with push button and LED: Privacy, Office, Apartment functions	\$1,806.00
LEBMD-GRW	Mobile enabled mortise deadbolt with LED: Privacy, Apartment functions	\$1,905.00
LEBSIMS-GRW	Mobile enabled mortise with HID Credential Secure Sector Compatibility with LED indicator: Storeroom function	\$1,891.00
LEBSIMB-GRW	Mobile enabled mortise with HID Credential Secure Sector Compatibility with push button and LED: Privacy, Office, Apartment functions	\$1,935.00
LEBSIMD-GRW	Mobile enabled mortise deadbolt with HID Credential Secure Sector Compatibility with LED: Privacy, Apartment functions	\$2,033.00

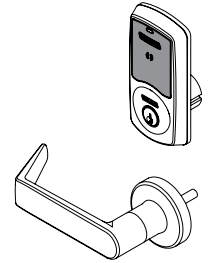

Outside

4. Select cylinder type
Price adjustment

		Open	Restricted
<input type="checkbox"/> ● P6	Mortise cylinder, Schlage® 6-pin (Everest 29 S123 standard)	No charge	\$30.00
● Z	Mortise cylinder, Schlage Everest SL, 7-pin (factory master keyed only)	N/A	\$30.00
L	Less mortise cylinder	-\$114.00	-\$114.00
<input type="checkbox"/> ● R	FSIC with cylinder, Schlage 6-pin (Everest 29 S123 standard)	\$102.00	\$132.00
J	Less FSIC, Schlage, 6-pin	No charge	No charge
T	FSIC construction core	\$102.00	N/A
<input type="checkbox"/> ● G	SFIC with cylinder, Schlage 7-pin (Everest 29R standard) (factory master keyed only)	N/A	\$135.00
B	Less SFIC, Schlage, Falcon®, competitive OEM's, 7-pin	-\$15.00	-\$15.00
H	SFIC construction core	\$62.00	N/A
BDC	SFIC disposable	-\$15.00	N/A
50-231	Construction core handling charge (non-refundable)	\$14.60	\$14.60

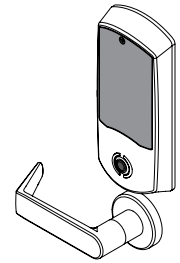

MS with LED

● Master keyed cylinders will be shipped in lock package. To specify, send Master Keying System Summary form (page 296 of SES price book) with order or go to kss.allegion.com.

△ For master keying, an additional charge of \$28.30 each applies. Specify line item 50-210.

Control keys for installation/removal of interchangeable cores are not furnished and must be ordered separate.

Note: Maximum door thickness with SFIC Cylinder is 2", otherwise compatible with 1-3/4" to 2-1/4" doors.

For additional assistance on Master Keying as well as restricted keyways, please contact customer service.

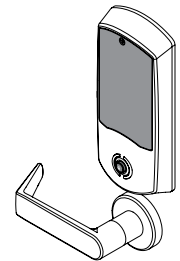

MB with interior push button and LED

5. Select outside lever
Price adjustment

03	Suites with Tubular style	No charge
06	Suites with Rhodes style	No charge
07	Suites with Athens style	No charge
17	Suites with Sparta style	No charge
LAT	Latitude	No charge
Standard options	01, 02, 05, 12, 18, LON, OME, ACC, AST, MER, 41, 42 (also 03, 06, 07, 17, and LAT)	No charge
M Collection options	M51, M52, M53, M54, M55, M56, M61 ¹ , M63, M81, M82, M83, M84, M85, ME1, ME2, ME3	\$30.00
8xx ²	Tactile Warning on standard levers available for 01, 02, 03, 05, 06, 07, 12, 17, and 18	\$71.00
8xx ²	Tactile Warning on M collection levers available for M51, M52, and M81	\$103.00

1. M61 is not offered in 612 finish.

2. Ordering instructions: Preface lever design code with 8. Example: 803 for 03, 851 for M51, etc.

Applied to exterior lever only unless otherwise specified. Not available with 643e finish.

Reference pages 52 and 53 to see style option images.

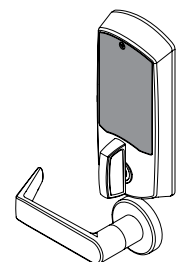

MD Deadbolt with LED

6. Select outside finish
Price adjustment

626	Satin Chrome	No charge
605	Bright Brass	\$86.00
606	Satin Brass	\$86.00
612 ³	Satin Bronze	\$86.00
619	Satin Nickel	\$86.00
622	Matte Black	\$86.00
625	Bright Chrome	\$86.00
643e	Aged Bronze	\$86.00
626AM	Satin Chrome Antimicrobial	\$123.00

3. 00C rose not available in 612 finish.

GREENWICH

LE MOBILE ENABLED WIRELESS LOCK

7. Select outside rose		Price adjustment
00A	2-1/8" (54 mm) diameter	Standard
00B	2-9/16" (65 mm) diameter	No charge
00C	2-5/8" (66 mm) diameter with bevel (Not available in 612 finish)	No charge
AVA	Decorative rose 2-5/8" (66 mm) diameter, supports ACC lever only	No charge
MER	Decorative rose 2-5/8" (66 mm) diameter, supports MER lever only	No charge

8. Select inside lever (Note: Specify only if different from Outside Lever.)		Price adjustment
Standard options	01, 02, 03, 05, 06, 07, 12, 17, 18, LAT, LON, OME, ACC, AST, MER, 41, and 42	No charge
M Collection options ⁴	M51, M52, M53, M54, M55, M56, M61, M63, M81, M82, M83, M84, and M85	\$30.00

4. \$30.00 price adder for M Collection levers only applies if outside lever is Standard.

9. Select inside finish ⁵ (Note: Specify only if different from Outside Finish.)		Price adjustment
See options in section 6.		\$86.00-\$123.00

5. Upcharge only applies if outside finish is 626 and you are specifying a different inside finish.

10. Select inside rose (Note: Specify only if different from Outside Rose.)		Price adjustment
See options in section 7.		No charge

11. Select handing (field reversible)		Price adjustment
RH	Right handed	Standard
LH	Left handed	No charge
RHR	Right handed reverse	No charge
LHR	Left handed reverse	No charge

12. Select strike lip length		Price adjustment
10-136	1-3/16" lip length (MS and MB only)	Standard
10-136-112	1-1/2" lip length (MS and MB only)	No charge
10-136-134	1-3/4" lip length (MS and MB only)	\$40.40
10-072	1-3/16" lip length (MD only)	Standard
10-072-112	1-1/2" lip length (MD only)	No charge
10-072-134	1-3/4" lip length (MD only)	\$46.50

13. Select door thickness		Price adjustment
134	1-3/4"	Standard
200	2"	\$75.80
214	2-1/4"	\$75.80

14. Select keying type		Price adjustment
Open keyway families (Mortise cylinder or FSIC)⁶		
S123	Everest 29 S (Key in Lever or FSIC)	Standard
C123	Everest C	No charge
C/CE/E/EF/F/FG/G	Classic Obverse	No charge
Restricted keyway families (Mortise cylinder or FSIC)^{6,7}		
29T	Everest 29 T	\$30.00
D	Everest D	\$30.00
29R	Everest 29 R (Everest SL)	\$30.00
B	Everest 29 B (Everest SL)	\$30.00
Classic Restricted	Quad, Numbered, Reverse	\$30.00
Restricted keyway families (SFIC)⁸		
29R	Everest 29 R	No charge
B	Everest B	No charge

6. Full size key systems (Everest 29 S and T, Everest C and D, Obverse and Quad) are available in Primus and Primus XP key system and must be ordered separately. Lock should be ordered less cylinder and Primus cylinder should be a separate line item.

7. Everest Restricted Keyways require a Letter of Authorization submitted with the order. See sample Letter of Authorization, page 302 of SES price book.

8. For restricted keyways, see page 4.

ADDISON

LE MOBILE ENABLED WIRELESS LOCK

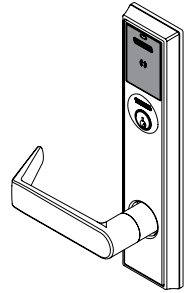

Outside

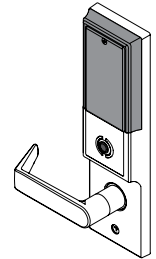

MS with LED

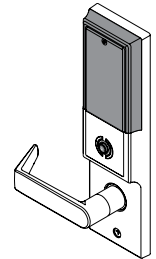

MB with interior push button and LED

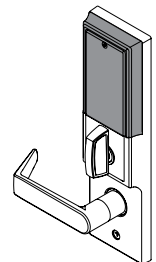

MD Deadbolt with LED

1-3. Select chassis/function/style

Price

Check with access control software partner or PACS provider to verify function and/or mobile enabled version is supported by software.		
LEBMS-ADD	Mobile enabled mortise with LED indicator: Storeroom function	\$1,821.00
LEBMB-ADD	Mobile enabled mortise with push button and LED: Privacy, Office, Apartment functions	\$1,865.00
LEBMD-ADD	Mobile enabled mortise deadbolt with LED: Privacy, Apartment functions	\$1,963.00
LEBSIMS-ADD	Mobile enabled mortise with HID Credential Secure Sector Compatibility with LED indicator: Storeroom function	\$1,949.00
LEBSIMB-ADD	Mobile enabled mortise with HID Credential Secure Sector Compatibility with push button and LED: Privacy, Office, Apartment function	\$1,993.00
LEBSIMD-ADD	Mobile enabled mortise deadbolt with HID Credential Secure Sector Compatibility with LED: Privacy, Apartment functions	\$2,091.00

4. Select cylinder type

Price adjustment

Open Restricted

		Open	Restricted
△ ● P6	Mortise cylinder, Schlage® 6-pin (Everest 29 S123 standard)	No charge	\$30.00
● Z	Mortise cylinder, Schlage 7-pin (Everest SL standard) (factory master keyed only)	N/A	\$30.00
L	Less mortise cylinder	-\$114.00	-\$114.00
□ ● R	FSIC with cylinder, Schlage 6-pin (Everest 29 S123 standard)	\$102.00	\$132.00
J	Less FSIC, Schlage, 6-pin FSIC	No charge	No charge
T	FSIC construction core	\$102.00	N/A
□ ● G	SFIC with cylinder, Schlage 7-pin (Everest 29R standard) (factory master keyed only)	N/A	\$135.00
B	Less SFIC, Schlage, Falcon®, competitive OEM's, 7-pin	-\$15.00	-\$15.00
H	SFIC construction core	\$62.00	N/A
BDC	SFIC disposable	-\$15.00	N/A
50-231	Construction core handling charge (non-refundable)	\$14.60	\$14.60

● Master keyed cylinders will be shipped in lock package. To specify, send Master Keying System Summary form (page 296 of SES price book) with order or go to kss.allegion.com.

△ For master keying, an additional charge of \$28.30 each applies. Specify line item 50-210.

□ Control keys for installation/removal of interchangeable cores are not furnished and must be ordered separate.

Note: Maximum door thickness with SFIC Cylinder is 2", otherwise compatible with 1-3/4" to 2-1/4" doors.

For additional assistance on Master Keying as well as restricted keyways, please contact customer service.

5. Select outside lever

Price adjustment

03	Suites with Tubular style	No charge
06	Suites with Rhodes style	No charge
07	Suites with Athens style	No charge
17	Suites with Sparta style	No charge
LAT	Latitude	No charge
Standard options	01, 02, 05, 12, 18, LON, OME, ACC, AST, MER, 41, 42 (also 03, 06, 07, 17, and LAT)	No charge
M Collection options	M51, M52, M53, M54, M55, M56, M61, M63, M81, M82, M83, M84, M85, ME1, ME2, ME3	\$30.00
8xx ¹	Tactile Warning on standard levers available for 01, 02, 03, 05, 06, 07, 12, 17, and 18	\$71.00
8xx ¹	Tactile Warning on M collection levers available for M51, M52, and M81	\$103.00

1. Ordering instructions: Preface lever design code with 8. Example: 803 for 03, 851 for M51, etc.

Applied to exterior lever only unless otherwise specified. Not available with 643e finish.

Reference pages 52 and 53 to see style option images.

6. Select outside finish

Price adjustment

626	Satin Chrome	No charge
605	Bright Brass	\$86.00
606	Satin Brass	\$86.00
612	Satin Bronze	\$86.00
619	Satin Nickel	\$86.00
622	Matte Black	\$86.00
625	Bright Chrome	\$86.00
643e	Aged Bronze	\$86.00
626AM	Satin Chrome Antimicrobial	\$123.00

ADDISON

LE MOBILE ENABLED WIRELESS LOCK

7. Select outside rose

(Note: Not applicable to Addison)

8. Select inside lever (Note: Specify only if different from Outside Lever.) **Price adjustment**

Standard options	01, 02, 03, 05, 06, 07, 12, 17, 18, LAT, LON, OME, ACC, AST, MER, 41, 42	No charge
M Collection options ²	M51, M52, M53, M54, M55, M56, M61, M63, M81, M82, M83, M84, M85	\$30.00

2. \$30.00 price adder for M Collection levers only applies if outside lever is Standard.

9. Select inside finish³ (Note: Specify only if different from Outside Finish.) **Price adjustment**

See options in section 6.		\$86.00-\$123.00
---------------------------	--	------------------

3. Upcharge only applies if outside finish is 626 and you are specifying a different inside finish.

10. Select inside rose

Not applicable to Addison

11. Select handing (field reversible) **Price adjustment**

RH	Right handed	Standard
LH	Left handed	No charge
RHR	Right handed reverse	No charge
LHR	Left handed reverse	No charge

12. Select strike lip length **Price adjustment**

10-136	1-3/16" lip length (MS and MB only)	Standard
10-136-112	1-1/2" lip length (MS and MB only)	No charge
10-136-134	1-3/4" lip length (MS and MB only)	\$40.40
10-072	1-3/16" lip length (MD only)	Standard
10-072-112	1-1/2" lip length (MD only)	No charge
10-072-134	1-3/4" lip length (MD only)	\$46.50

13. Select door thickness **Price adjustment**

134	1-3/4"	Standard
200	2"	\$75.80
214	2-1/4"	\$75.80

14. Select keying type **Price adjustment**

Open keyway families (Mortise cylinder or FSIC) ⁴		
S123	Everest 29 S (Key in Lever or FSIC)	Standard
C123	Everest C	No charge
C/CE/E/EF/F/FG/G	Classic Obverse	No charge
Restricted keyway families (Mortise cylinder or FSIC) ^{4,5}		
29T	Everest 29 T	\$30.00
D	Everest D	\$30.00
29R	Everest 29 R (Everest SL)	\$30.00
B	Everest 29 B (Everest SL)	\$30.00
Classic Restricted	Quad, Numbered, Reverse	\$30.00
Restricted keyway families (SFIC) ⁶		
29R	Everest 29 R	No charge
B	Everest B	No charge

4. Full size key systems (Everest 29 S and T, Everest C and D, Obverse and Quad) are available in Primus and Primus XP key system and must be ordered separately. Lock should be ordered less cylinder and Primus cylinder should be a separate line item.

5. Everest Restricted Keyways require a Letter of Authorization submitted with the order. See sample Letter of Authorization, page 302 of SES price book.

6. For restricted keyways, see page 4.

PARTS AND ACCESSORIES

LEVER AND KNOB KITS																
⌘ Extended factory lead time ⌘ Specify handing						Available finishes										
Style	Lever and knob style					605	606	609	612	613	619	622	625	626	643e	626AM
Standard	01, 02, 03, 05, 06, 07, 12, 17, 18, 41, 42, OME					▪	▪	N/A	▪	N/A	▪	▪	▪	▪	▪	▪
	ACC, AST, MER, LAT, LON					▪	▪	N/A	N/A	N/A	▪	▪	▪	▪	▪	▪
Decorative	M51, M52, M53, M54, M55, M56, M61, M63, M81, M82, M83, M84, and M85, ME1, ME2, ME3					▪	▪	N/A	N/A	N/A	▪	▪	▪	▪	▪	▪
Description	Specify					Standard levers/knobs	M Collection levers									
	Part number	Lever/knob style	Finish	Door thickness												
Outside lever/knob, retaining clip, insertion tool	09-401	.[Lever/knob]	.[Finish]	.[]												
Inside lever + bushing, mounting plate, screw pack, spanner wrench	09-402	.[Lever/knob]	.[Finish]	.[]	\$258.00	\$273.00										

Knobs and levers standard default is for 1-3/4" door. 2" and 2-1/4" door widths also available. Specify door thickness if not 1-3/4".

ROSE KITS (GREENWICH ONLY)																
⌘ Extended factory lead time ⌘ Specify handing						Available finishes										
Style	Lever and knob style					605	606	609	612	613	619	622	625	626	643e	626AM
Standard	00A, 00B, 00C					▪	▪	N/A	▪	N/A	▪	▪	▪	▪	▪	▪
Decorative	MER, AVA					▪	▪	N/A	N/A	N/A	▪	▪	▪	▪	▪	▪
Description	Specify					Standard and M Collection										
	Part number	Lever/knob style	Rose	Finish												
Inside rose (Includes mounting plate and screws)	09-403	.[Lever/knob]	.[Rose]	.[Finish]		\$146.00										
Outside rose + bushing	09-404	.[Lever/knob]	.[Rose]	.[Finish]		\$146.00										
Blank outside rose (not available MER or AVA)	09-508	.[Lever/knob]	.[Rose]	.[Finish]		\$146.00										

Lever design must be specified for proper bushing.

OUTSIDE GREENWICH LEVER/KNOB AND ROSE SUBASSEMBLIES																
⌘ Extended factory lead time ⌘ Specify handing						Available finishes										
Style	Lever and knob style					605	606	609	612	613	619	622	625	626	643e	626AM
Standard	01, 02, 03, 05, 06, 07, 12, 17, 18, 41, 42, OME					▪	▪	N/A	▪	N/A	▪	▪	▪	▪	▪	▪
	ACC, AST, MER, LAT, LON					▪	▪	N/A	N/A	N/A	▪	▪	▪	▪	▪	▪
Decorative	M51, M52, M53, M54, M55, M56, M61, M63, M81, M82, M83, M84, and M85, ME1, ME2, ME3					▪	▪	N/A	N/A	N/A	▪	▪	▪	▪	▪	▪
Description	Specify					Standard levers/knobs	M Collection levers									
	Part number	Lever/knob style	Rose	Finish												
Outside lever/knob assembly for 00A, 00B or 00C rose	09-506	.[Lever/knob]	.[Rose]	.[Finish]	\$286.00	\$301.00										
Outside lever assembly for AST with Avanti rose or MER with Merano rose only	09-655	.[Lever/knob]	.[Rose]	.[Finish]	\$286.00	N/A										

PARTS AND ACCESSORIES

INSIDE SUBASSEMBLIES		Available finishes												
		605	606	609	612	613	619	622	625	626	629	630	643e	626AM
		▪	▪	N/A	▪	N/A	▪	▪	▪	▪	N/A	N/A	▪	▪
Greenwich inside trim assembly without battery cover														
Description	Contents	Specify		Price each										
		Part number	Finish											
Mobile enabled mortise deadbolt (BMD)	Complete trim minus battery cover, battery holder, and mounting screws	47270612	.[Finish]	\$691.00										
Mobile enabled mortise with push button (BMB)		47270613	.[Finish]	\$686.00										
Mobile enabled mortise with LED (BMS)		47270614	.[Finish]	\$671.00										
Addison inside escutcheon assembly without battery cover														
Description	Contents	Specify		Price each										
		Part number	Finish											
Mobile enabled mortise deadbolt (BMD)	Complete escutcheon minus battery cover, battery holder, and mounting screws	47270616	.[Finish]	\$757.00										
Mobile enabled mortise with push button (BMB)		47270617	.[Finish]	\$750.00										
Mobile enabled mortise with LED (BMS)		47270618	.[Finish]	\$744.00										

BMD, BMB, and BMS subassemblies can be used to upgrade an existing LE lock to a LEB mobile enabled lock. This is the only part number needed.

OUTSIDE SUBASSEMBLIES		Available finishes												
		605	606	609	612	613	619	622	625	626	629	630	643e	626AM
		▪	▪	N/A	▪	N/A	▪	▪	▪	▪	N/A	N/A	▪	▪
Greenwich trim														
Description	Contents	Specify		Price each										
		Part number	Finish											
Greenwich trim ¹	(1) Outside reader (electronics and trim) (1) Grounding spring (1) Harness (1) Cover (1) Back plate (2) Screws	L483-016	.[Finish]	\$579.00										
Addison escutcheon														
Description	Contents	Specify			Standard levers/knobs	M Collection levers								
		Part number	Lever/knob style	Finish										
Addison escutcheon	(1) Outside reader (electronics and escutcheon) 47270612 (1) Harness (1) Lever	L483-017	.[Lever/knob]	.[Finish]	\$893.00	\$908.00								
Addison escutcheon ²	(1) Outside reader (electronics and escutcheon) 47270612 (1) Harness	L483-051	-	.[Finish]	\$686.00	-								

1. Does not support HID Secure Sector compatibility.
2. Lever not included.

PARTS AND ACCESSORIES

BATTERY PARTS		
Description	Specify	Price each
Battery harness	L483-039	\$13.00
Battery holder	N623-006	\$49.00
Greenwich battery cover with screw, washer, and magnet	L483-025	\$49.00
Addison battery cover with screw, washer, and magnet	L483-031	\$53.00

ARMOR FRONTS	Available finishes										
	605	606	609	612	613	619	622	625	626	643e	626AM
	▪	▪	N/A	▪	N/A	▪	▪	▪	▪	▪	▪
Description	Specify		Price each								
	Part number	Finish									
1-1/4" wide for 1-3/4" and larger door thicknesses (for MS, MB, MD)	09-666	.[Finish]	\$53.00								

STRIKES	Available finishes											
	605	606	609	612	613	619	622	625	626	643e	626AM	
	▪	▪	N/A	▪	N/A	▪	▪	▪	▪	▪	▪	
Description	Contents	Specify		Price each								
		Part number	Finish									
1-1/4" x 4-7/8" strike, 1-3/16" lip length, std. (MS and MB)	(1) Square corner strike	10-136	.[Finish]	\$55.00								
1-1/4" x 4-7/8" strike, 1-1/2" lip length (MS and MB)	(2) Screws	10-136-112	.[Finish]	\$56.00								
1-1/4" x 4-7/8" strike, 1-3/4" lip length (MS and MB)	(1) Strike box (includes DPS magnet)	10-136-134	.[Finish]	\$94.00								
Strike box with magnet tray only (MS and MB)	-	L583-761	-	\$22.50								
DPS magnet (For L583-761 only)	-	L583-760	-	\$22.50								
1-1/4" x 4-7/8" strike, 1-3/16" lip length, std. (MD only)	(1) Square corner strike	10-072	.[Finish]	\$32.00								
1-1/4" x 4-7/8" strike, 1-1/2" lip length (MD only)	(2) Screws	10-072-112	.[Finish]	\$32.00								
1-1/4" x 4-7/8" strike, 1-3/4" lip length (MD only)	(1) Strike box	10-072-134	.[Finish]	\$82.00								
Strike box only (MD only)	-	K510-066	-	\$9.70								

MORTISE CYLINDERS	Available finishes										
	605	606	609	612	613	619	622	625	626	643e	626AM
	▪	▪	N/A	▪	N/A	▪	▪	▪	▪	▪	▪
Cylinder only	Specify			Price each							
	Part number	Finish	Cyl. Length	Open	Restricted						
Conventional (non-Everest, non-Primus) - 1-1/2" length	30-021-112	.[Finish]	.112	\$132.00	\$162.00						
Primus controlled access - 1-1/2" length	20-793-112	.[Finish]	.112	\$237.00							
Primus XP controlled access - 1-1/2" length	20-793-112-XP	.[Finish]	.112	\$237.00							
Primus UL 437 - 1-1/2" length	20-593-112	.[Finish]	.112	\$296.00							
Primus XP UL 437 - 1-1/2" length	20-593-112-XP	.[Finish]	.112	\$296.00							

Note: 1-1/2" cylinders support 1-3/4" through 2-1/4" door thickness.
 If 1-3/4" thick door, a 1-3/8" cylinder can be used by designating 138 in place of 112 in table above. If this is done deduct \$27.00 from list price in table.

PARTS AND ACCESSORIES

CYLINDER HOUSING WITHOUT CORE	Available finishes											
	605	606	609	612	613	619	622	625	626	643e	626AM	
	▪	▪	▪	▪	▪	▪	▪	▪	▪	▪	▪	N/A
Cylinder type	Specify			16'								
	Part number	Finish	Cyl. Length	Price each								
FSIC	30-016	.[Finish]	.112	\$123.00								
SFIC ^{1,2}	80-108	.[Finish]	.138	\$105.00								

1. Cylinders include compression spring.
2. Not available for 2-1/4" door thickness.

MORTISE CHASSIS AND WIRE HARNESES		
Description	Specify	Price each
Chassis with harness (MS and MB only)	L483-000	\$1,159.00
Chassis with harness (MD only)	L483-001	\$1,398.00
Chassis harness with RX module switch	L483-007	\$148.00
Reader harness	L483-018	\$43.00
DPS kit (external, MD only) Contains: magnet, switch, and harness	L483-055	\$53.00

DOOR PARTS		
Description	Specify	Price each
(2) Spacers for ANSI A115.1 metal door preparations	L283-029	\$53.00

KNOB PARTS		
Description	Specify	Price each
(1) Pack of truarc ring, (2) spacer, knobs	K110-550	\$12.60
Mounting plate, inside knob	L583-321	\$10.60

LEVER PARTS		
Description	Specify	Price each
Pack of 20 truarc rings, levers	L283-030	\$31.40
(1) Mounting post (ferrule) for 1-3/4" door thickness	L583-212	\$16.80
(1) Mounting post (ferrule) for 2" door thickness	L583-213	\$16.80
(1) Mounting post (ferrule) for 2-1/4" door thickness	L583-214	\$16.80
Mounting plate, inside lever	L283-031	\$28.60
Spring cage (1 required per lever)	L283-040	\$14.10
Mounting plate screw (2 required per lock)	L583-066	\$1.90
Spindles and springs for 1-3/4" to 1-7/8" doors (2 each)	L283-198	\$22.90
Spindles and springs for 2" to 2-1/4" doors (2 each)	L283-199	\$27.00
Spindle and spring for 1-3/4" to 1-7/8" doors (qty: 1 - 2 required per lock)	L283-060	\$11.40
Spindle and spring for 2" to 2-1/4" doors (qty: 1 - 2 required per lock)	L283-061	\$14.10

PARTS AND ACCESSORIES

INSTALLATION TOOLS		
Description	Specify	Price each
Universal clamp	40-286	\$662.00
L/LE Series installation template	40-248	\$58.00
Universal mortise door position switch (DPS) installation template (For use with only LE-MD lock)	40-291	\$215.00
Mortise pocket filler (edge)	40-158	\$258.00

The universal clamp above is necessary when using the remaining products to ensure hole placement accuracy. These installation tools function together and form a complete LE installation kit. The "Universal" (Clamp and DPS) products are for use in all CO, AD and LE product installations.

ENGAGE™ WIRELESS TEST KIT AND ACCESSORIES		
Description	Specify	Price each
TKE - ENGAGE™ Test kit. For use in pre-installation test applications. Comes with 2 TKE Transponders, ENGAGE gateway, tripod, TKE gateway bracket, battery, and backpack carry case	47271232	\$2,632.00
TKE Transponder	47269850	\$819.00
TKE Gateway bracket (Tripod adapter)	47269870	\$67.00



Contents

NDE Lock Overview	68
How to order.....	69
NDE Lock Functions	71
NDE Lock Styles.....	72
NDE Lock Configure a product.....	73
Cylinders.....	74
Style options	75
Less components.....	75
NDE Wireless lock cylindrical.....	76
NDE Lock Parts	79
Inside/outside escutcheon subassemblies	79
Reader PCBA.....	79
Battery holder kit.....	79
Levers and related components.....	79
Latches and related components.....	81
Strikes.....	81
Competitor core/compatibility parts.....	82
Reinforcements.....	82
Motorized chassis assembly	83
Tailpieces.....	83
Main wire harness	83
Inside baseplate.....	83
Spring cages.....	83
Conversion kits.....	84
Screws and screw packs.....	84
Torx® screw packs.....	84
Cylinder reference table.....	85
ENGAGE™ Wireless test kit	85
Installation tools	85

Finish codes and descriptions

BHMA code	Description
605	Bright brass
606	Satin brass
612	Satin bronze
619	Satin nickel
622	Matte black
625	Bright chromium plated
626	Satin chrome
626AM	Satin stainless steel, antimicrobial 
643e	Aged bronze

Standard features



Certification	ANSI/BHMA Certified A156.25-2013, A156.2-2011, Series 4000, Grade 1, UL 294, UL 10C
Latch	1-1/8" x 2-1/4", Square corner faceplate, 1" housing diameter, 1/2" throw
Strike	1-1/4" x 4-7/8", ANSI Square corner, no box
Backset	2-3/4"
Cylinder	6-pin solid brass, keyed 6-pin, S123 keyway, keyed different (KD)
Door range	Comes set for 1-3/4" thick doors. Can be field adjusted for doors 1-5/8"-2" thick
Keys	Two nickel silver cut keys per lock, 6-pin, S123 section

How to order NDE Lock

REQUIRED FIELDS		FACTORY DEFAULT AND OPTIONS							
NDEB	J	LAT	626AM	SPA	605	13-247	47267101	S123	K510-066

1. Series (Vandgard only)

- NDEB Mobile enabled cylindrical lock (with interior pushbutton with indicator)
- NDEBSI Mobile enabled cylindrical lock with HID credential secure sector compatibility (with interior pushbutton with indicator)

2. Cylinder type

- P6 Schlage KIL format
- For all options see NDE ordering pages

3. Outside lever¹

- ATH Athens
- BRK Boardwalk
- BRW Broadway
- LAT Latitude
- LON Longitude
- OME Omega
- RHO Rhodes
- SPA Sparta
- TLR Tubular

¹ Tactile warning available - see Lever Designs on page 72

4. Outside finish

- | | | | |
|-------|--------------------------------------|------|---------------|
| 605 | Bright Brass | 622 | Matte Black |
| 606 | Satin Brass | 625 | Bright Chrome |
| 612 | Satin Bronze | 626 | Satin Chrome |
| 619 | Satin Nickel | 643e | Aged Bronze |
| 626AM | Satin Chrome (Antimicrobial Coating) | | |

5. Inside lever (specify only if different from outside lever)

- See options under 3 above
- Omega (OME) levers are very close to the escutcheon when rotated – consider Sparta (SPA) levers as a substitute
- Tactile levers not available for inside lever

6. Inside finish (specify only if different from outside lever)

- See options under 4 above

7. Latch

- 13-247 2-3/4" backset; 1/2" throw bolt; 1-1/8" x 2-1/4" faceplate (standard for both series)
- For all options see NDE ordering pages

8. Strike

- NDEB 47267101 – 1-1/4" x 4-7/8" with 1-3/16" lip (10-025 with retained screws)
- For all options see NDE ordering pages

9. Keyway

- S123 Everest 29 (standard for both series)
- For all options see NDE ordering pages

10. Additional options

- For all options see NDE ordering pages



Customer service	Technical support
<ul style="list-style-type: none"> Order status Credit returns of non-defective products General sales questions 	<ul style="list-style-type: none"> Technical questions/issues Returns of defective products Repairs
USA Allegion_Orders@allegion.com CAN Canada.CustomerService@allegion.com	USA Electronic_Lock_TechProdSupport@allegion.com CAN Canada.TechServices@allegion.com

Common pricing information	
1.	Locks are furnished with standard features unless otherwise specified.
2.	Door thickness is 1-3/4".
3.	Split finishes and designs will be priced at the highest list price of the design and/or finish.
4.	Engineering specials are denoted by a part number beginning with "X" and are not subject to standard discounting.
5.	∞ denotes a lock or part that requires an extended lead time.
6.	For all restricted keyways (Everest B, D, 29R, and 29T, also Quad, Numbered, and Reversed) add \$30.00. This does not apply to Primus cylinders. See page 4 for ordering information and requirements.
7.	Locks, keys, and cylinders containing restricted keyways require additional documentation to order. Please see page 4 for the specific requirements.
8.	Keyway must be specified for keyed functions and cylinders. If not specified, default keyway will be S123 for KA, KD, and 0-bitted product and S145 for Factory managed masterkey systems.
9.	Multiple keying options are available. Locks and cylinders are furnished KD unless otherwise specified or excepted by notation.
10.	Control Keys for permanent and construction cores are not included with the lock or cylinder and must be ordered separately.
11.	Locks specified with "C" keyway and KD or 0-bitted will receive 6-pin cylinders (keyed 5) with 5 pin keys.
12.	Full Size Interchangeable Cores (FSIC) are furnished 1-bitted unless otherwise specified. If 0-bitted is selected, the order will be entered as 1-bitted. This does not apply to FSIC Primus® cores.
13.	Conventional cylinders, Primus cylinders (conventional and FSIC) can be supplied 0-bitted. If 1-bitted is selected, the order will be entered as 0-bitted.
14.	Available plug face finishes are 606, 622, 626, and 643e.



ANSI/BHMA Certified A156.25-2013, A156.2-2011, Series 4000, Grade 1, UL 294, UL 10C

NDEB AND NDEBSI - INTERIOR PUSH BUTTON (FUNCTION SELECTABLE VIA ENGAGE™ MOBILE APP)	
Storeroom/ Classroom	Lockset is normally secure with outside lever disengaged. Valid normal credential or key momentarily unlocks door. Valid toggle credential may be used to change to a passage or secured state. Interior push button on inside housing confirms state of the lock via LED indicator. A mechanical key will retract the latch. Inside lever always allows free egress.
Office	Lockset is normally secure with outside lever disengaged. Valid normal credential or key momentarily unlocks door. Valid toggle credential may be used to change to a passage or secured state. Interior push button on inside housing can be used to select a passage or secured state and confirms state of the lock via LED indicator. A mechanical key will retract the latch. Inside lever always allows free egress. Meets the need for lockdown function for safety and security.
Privacy	Lockset is normally secure with outside lever disengaged. Valid normal credential or key momentarily unlocks door. Valid toggle credential may be used to change to a passage or secured state. Interior pushbutton on inside housing may be used to select a privacy status. The interior pushbutton will disable normal electronic access from the exterior and confirms state of the lock via LED indicator. Opening the door or pressing the interior pushbutton a second time on the inside housing deactivates the privacy status. A mechanical key will always retract the latch. Inside lever always allows free egress. Door position sensor required for function.
Apartment	Lockset is normally secure with outside lever disengaged. Valid normal or toggle credential is used to change to a passage or secured state. Interior pushbutton on inside housing may be used to select a passage or secured state and confirms state of the lock via LED indicator. Opening the door or pressing the interior pushbutton a second time causes the lockset to toggle to passage. While in passage mode, the lockset can only be secured while the door is closed by pressing the interior pushbutton or using a normal credential on the exterior. A mechanical key will retract the latch. Inside lever always allows free egress. Door position sensor required for function.



LEVER DESIGNS

ATHENS (ATH)

Tactile option: 8AT (milled)

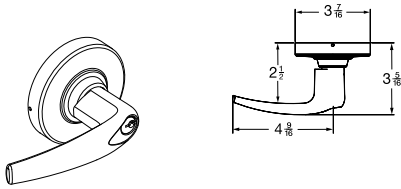

BOARDWALK (BRK)

Tactile option: 8BK (knurled)

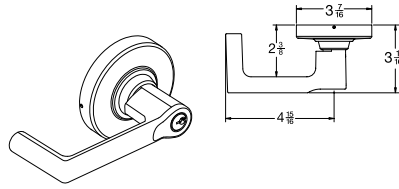

BROADWAY (BRW)

Tactile option: 8BY (knurled)

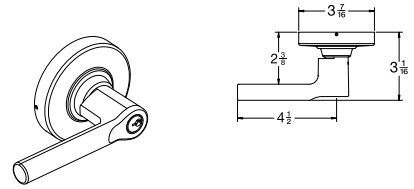

LATITUDE (LAT)

Tactile option: 8LT (milled)

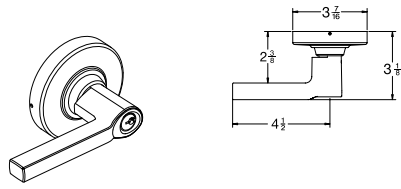

LONGITUDE (LON)

Tactile option: 8LN (milled)

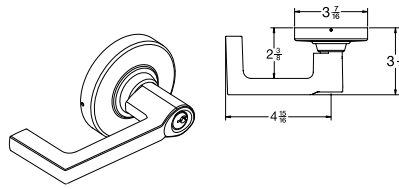

OMEGA (OME)

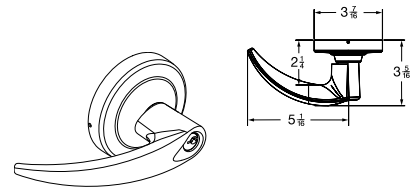

RHODES (RHO)

Tactile option: 8RO (milled)

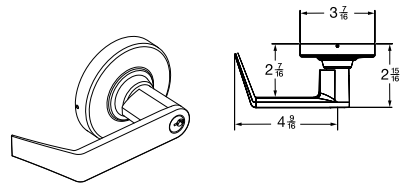

SPARTA (SPA)

Tactile option: 8SP (milled)

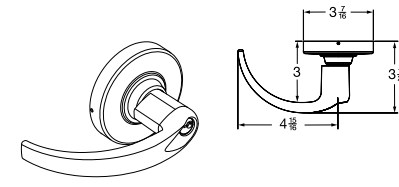

TUBULAR (TLR)

Tactile option: 8TR (knurled)

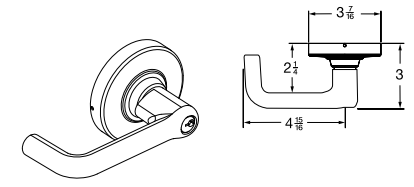

COMMERCIAL LEVER SUITING							
NDE Levers	AD/CO Levers	ND Levers	L Lock Levers	98/99 Exit	ALX Lock	S Lock	F Lock
Athens	Athens	Athens	07	07	Athens	Jupiter	-
Sparta	Sparta	Sparta	17	17	Sparta	Neptune	Jazz
Rhodes	Rhodes	Rhodes	06	06	Rhodes	Saturn	Elan
Tubular	-	Tubular	-	-	Tubular	-	-
Omega	-	Omega	-	-	Omega	-	-
Latitude	-	Latitude	Latitude	Latitude	Latitude	-	Latitude
Longitude	-	Longitude	Longitude	Longitude	Longitude	-	-
Broadway	-	Broadway	-	-	Broadway	-	-
Boardwalk	-	Boardwalk	-	-	Boardwalk	-	-

You can **configure and price a full range of products** using the tables and rules shown in this section.

The pricing of locks in this section includes the P6 cylinder in an open keyway (where applicable), default latch, strike, and a 1-3/4" thick door. Additional modifications are available using the rules and price adjustments on the subsequent pages.

How to order:

- All applicable product attributes must be provided in the order shown below
- Each value must be separated by a period
- If requesting a product "Less (LLL)" any attribute, the entire detailed ACN must be provided
- Fractions will be written with the "/" symbol separating the numerator and the denominator (example 1/2)
- For dimensions that contain a whole number and a fraction, a hyphen "-" will be added after the whole number and before the fraction (example 2-1/4)
- For two dimensions represented together, such as length and width, the values would be separated by an "x" with no spaces
- Finishes should be listed using their BHMA finish as shown in this book

Quantity	Brand	Series	Cylinder	Outside lever design	Outside finish	Inside lever design	Inside finish	Backset & latch	Strike	Strike lip length	Options	Keying		
												Keying code	Keyway	Pack keys independently
1	2	3	4A	4B	5A	5B	6	7	8	9	10A	10B	10C	

Specify only if different than outside style

Only required when deviating from the product's default. Specify only the deviated attribute(s).

Only required when deviating from the product's default. Specify only the deviated attribute(s).

If ordering a product "Less (LLL)" any attribute, values for each attribute must be provided.

EXAMPLE:

NDEB . P6 . SPA . 626 . **RHO** . 13-247 . 47267101

5A

2
3
4A
4B
6
7

Inside lever design different than outside

COMPLETE LOCKS

CYLINDERS

Keyed locks are priced including the P6 cylinder with open keyway. Provided below are pricing adjustments based on other available cylinder types. For Primus and Primus XP cylinders, order lock less cylinder and order the Primus or Primus XP cylinder separately.

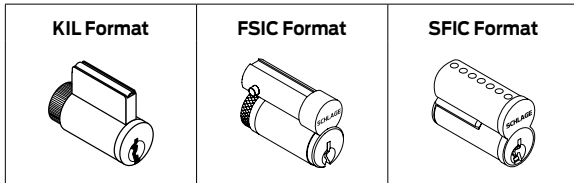

CYLINDERS	
P6	Conventional 6-pin cylinder
Z	Everest SL Conventional cylinder, 7-pin
L	Less conventional cylinder
R	FSIC (Full size interchangeable core)
T	FSIC - Construction core ²
J	Less FSIC
G	SFIC (Small format interchangeable core) 7-pin
H	Refundable Construction SFIC ²
BDC	Disposable SFIC
B	Less SFIC
J-MED ⓘ	Less FSIC - Medeco® (ATH, SPA, RHO and TLR only)
J-CO6 ⓘ	Less FSIC – Corbin Russwin® (6-pin) (ATH, SPA, RHO, and TLR only)
J-CO7 ⓘ	Less FSIC – Corbin Russwin (7-pin) (SPA only)
J-SAR ⓘ	Less FSIC – Sargent® (ATH, SPA, RHO, and TLR only)
J-YA6 ⓘ	Less FSIC – Yale® 1210 or Medeco 31*0100 (6-pin) (ATH, SPA, RHO, and TLR only)
J-YA7 ⓘ	Less FSIC – Yale (7-pin) (SPA only)
L-SAR ⓘ	Less Conventional, Sargent (ATH, SPA, RHO, and TLR only)
L-COR ⓘ	Less Conventional, Corbin Russwin (ATH, SPA, RHO, and TLR only)

ⓘ Extended lead time

1. Competitor lever designs come in finishes 626 standard, and 605, 606, 612, 619, 625, 643e, and 626AM with extended lead times.
2. For P, R, and G -Master Keyed cylinders can be specified and will be shipped in lock packaging.
3. For Master Key System Summary form which should accompany the master keyed order, see pages 296–301.
4. For Master Keying, additional line item 50-210 is required for Classic and Everest cylinders.
5. Control Keys for installation/removal of interchangeable cores are not furnished and must be ordered separate.
6. Spring cages and tailpieces are different based on the type of cylinder and chassis selected. Please see the [NDE Series Parts Guide](#) for more information.
7. The NDE Lock accepts many popular models of standard, SFIC, and FSIC cylinders. See pricebook for specific configurations.
8. For additional assistance on Master Keying, as well as restricted keyways, please contact your local sales representative.

COMPLETE LOCKS STYLE OPTIONS

Specify on order only if requesting an option other than the default.

- Tactile levers applied to exterior lever only unless otherwise specified.
- Not available with 643e finish.

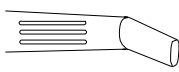
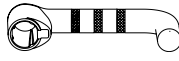
	MILLED PATTERN	KNURLED PATTERN	OPTIONAL	
			Specify	Price adjustment per lever
TACTILE WARNING				
Athens tactile lever	Milled	N/A	8AT	\$67.00
Boardwalk tactile lever	N/A	Knurled	8BK	\$67.00
Broadway tactile lever	N/A	Knurled	8BW	\$67.00
Latitude tactile lever	Milled	N/A	8LT	\$67.00
Longitude tactile lever	Milled	N/A	8LN	\$67.00
Omega tactile lever	N/A	N/A	N/A	N/A
Rhodes tactile lever	Milled	N/A	8RO	\$67.00
Sparta tactile lever	Milled	N/A	8SP	\$67.00
Tubular tactile lever	N/A	Knurled	8TR	\$67.00

COMPLETE LOCKS LESS COMPONENTS

Deductions are applied to complete lock prices. When requesting a product “Less (LLL)” any attribute, the entire detailed ACN must be provided.

LOCKS LESS COMPONENTS		
Description	Specify	Price adjustment
Less each lever	LLL	-\$34.10
Less latch	LLL	-\$52.40

CYLINDRICAL

NDE MOBILE ENABLED WIRELESS LOCK



NDE

1. Select product series		Price
NDEB	Mobile enabled cylindrical lock (with interior pushbutton with indicator) with Vandlgard	\$1,401.00
NDEBSI	Mobile enabled cylindrical lock with HID credential secure sector compatibility (with interior pushbutton with indicator) with Vandlgard	\$1,550.00

2. Select cylinder type		Price adjustment	
		Open	Restricted
<input type="checkbox"/> ● P6	With Cylinder, Schlage® - (Everest 29 S123, 6-pin KIL standard)	No charge	\$30.00
● Z	With Cylinder, Schlage - Everest SL, 6-pin KIL (factory master keyed only)	N/A	\$30.00
L	Less Cylinder, Schlage, 6-pin KIL	-\$90.00	-\$90.00
<input type="checkbox"/> ● R	With Cylinder, Schlage 6-pin (Everest 29 S123 standard) FSIC	\$102.00	\$132.00
J	Less Cylinder, Schlage, 6-pin FSIC	-\$55.00	-\$55.00
T	FSIC construction core	\$102.00	N/A
<input type="checkbox"/> ● G	SFIC with cylinder, Schlage 7-pin (Everest 29R standard) (factory master keyed only)	N/A	\$113.00
B	Less SFIC, Schlage, Falcon®, competitive OEM's, 7-pin	-\$55.00	-\$55.00
⊙ L-CO6	Less Cylinder, Corbin Russwin® KIL, 6-pin KIL	No charge	No charge
⊙ L-SAR	Less Cylinder, Sargent® (10L + 11L), 6-pin KIL	No charge	No charge
⊙ J-SAR	Less Cylinder, Sargent 6300, 6-pin FSIC	No charge	No charge
⊙ J-CO6	Less Cylinder, Corbin® 8000, 6-pin FSIC	No charge	No charge
⊙ J-CO7	Less Cylinder, Corbin 8000-7, 7-pin FSIC, (Only RHO, 8RO, SPA, 8SP)	No charge	No charge
⊙ J-MED	Less Cylinder, Medeco® 32*0201, 6-pin FSIC (Only RHO, 8RO, SPA, 8SP lever styles)	No charge	No charge
⊙ J-YA6	Less Cylinder, Yale® 1210 or Medeco 31*0100, 6-pin FSIC	No charge	No charge
⊙ J-YA7	Less Cylinder, Yale 1220, 7-pin FSIC (Only RHO, 8RO, SPA, 8SP lever styles)	No charge	No charge
H	SFIC construction core	\$30.00	N/A
BDC	SFIC disposable	-\$55.00	N/A
50-231	Construction core handling charge (non-refundable)	\$14.60	\$14.60

- Master Keyed cylinders can be specified and will be shipped in lock packaging. For Master Keying System Summary form which should accompany the master keyed order, see page 296.
 - △ For master keying, an additional charge of \$28.30 each applies. Specify line item 50-210.
 - Control keys for installation/removal of interchangeable cores are not furnished and must be ordered separate.
 - ⊙ Not available on BRK, BRW, LAT, or LON.
- For additional assistance on Master Keying as well as restricted keyways, please contact customer service.

3. Select outside lever		Price adjustment
LLL	Less each lever	-\$34.10
SPA	Sparta	No charge
RHO	Rhodes	No charge
ATH	Athens	No charge
TLR	Tubular	No charge
OME	Omega	No charge
LAT	Latitude	No charge
LON	Longitude	No charge
BRW	Broadway	No charge
BRK	Boardwalk	No charge
Tactile options	(8AT, 8LT, 8LN, 8RO, 8SP, 8BK, 8BW, 8TR)	\$67.00

Note: Credentials available, see pages 16–20.

CYLINDRICAL

NDE MOBILE ENABLED WIRELESS LOCK

4. Select outside finish		Price adjustment
626	Satin Chrome	No charge
605 [ⓧ]	Bright Brass	\$86.00
606 [ⓧ]	Satin Brass	\$86.00
612 [ⓧ]	Satin Bronze (00C rose not available in 612 finish)	\$86.00
619 [ⓧ]	Satin Nickel	\$86.00
622 [ⓧ]	Matte Black	\$86.00
625 [ⓧ]	Bright Chrome	\$86.00
643e [ⓧ]	Aged Bronze	\$86.00
626AM [ⓧ]	Satin Chrome Antimicrobial	\$123.00

[ⓧ] Extended lead time on all finishes except 626.

5. Select inside lever (Specify only if different from outside lever)		Price adjustment
LLL	Less each lever	-\$34.10
SPA	Sparta	No charge
RHO	Rhodes	No charge
ATH	Athens	No charge
TLR	Tubular	No charge
OME	Omega	No charge
LAT	Latitude	No charge
LON	Longitude	No charge
BRW	Broadway	No charge
BRK	Boardwalk	No charge
Tactile options	(8AT, 8LT, 8LN, 8RO, 8SP, 8BK, 8BW, 8TR)	\$67.00

Note: Credentials available, see pages 16–20.

6. Select inside finish (Specify only if different from outside finish) ¹		Price adjustment
626	Satin Chrome	No charge
605 [ⓧ]	Bright Brass	\$86.00
606 [ⓧ]	Satin Brass	\$86.00
612 [ⓧ]	Satin Bronze	\$86.00
619 [ⓧ]	Satin Nickel	\$86.00
622 [ⓧ]	Matte Black	\$86.00
625 [ⓧ]	Bright Chrome	\$86.00
643e [ⓧ]	Aged Bronze	\$86.00
626AM [ⓧ]	Satin Chrome Antimicrobial	\$123.00

1. Charge only applies if outside finish is 626 and you are specifying a different inside finish.

[ⓧ] Extended lead time on all finishes except 626.

7. Select backset and latch bolt		Price adjustment
LLL	Less Latch	-\$52.40
13-247	2-3/4" Backset, deadlatch, square corner, 1-1/8" x 2-1/4"	Standard
14-042	2-3/4" Backset, deadlatch anti-friction fire door latch, square corner	\$268.00
14-047	2-3/8" Backset, deadlatch square corner, 1-1/8" x 2-1/4"	No charge
14-048	2-3/8" Backset, deadlatch square corner, 1" x 2-1/4"	No charge



NDE WIRELESS ELECTRONIC

MOBILE ENABLED CYLINDRICAL LOCK

8-9. Select strike plate and strike lip length**Price adjustment**

47267101 ^{2,3}	1-3/16" Lip, ANSI, no box, 1-1/4" x 4-7/8" (10-025 with retained screws)	Standard
10-016 ³	1-1/8" Lip, square corner, T-strike, fire door latch	\$26.10
C603-623	Dust box for T-strike, 10-013	No charge
B502-853	Deep dust box for T-strike, 10-016	No charge
K510-066	Box for ANSI strike (Must be specific)	No charge

2. 1-3/8" Lip available, must specify 1-3/8" Lip \$42.00. 1-1/2" Lip available, must specify 1-1/2" Lip \$42.00.

3. DPS magnet requires prep and install beneath strike.

10. Select keying type**Price adjustment**

Open keyway families: KIL or FSIC⁴		
S123	Everest 29 S (Key in Lever or FSIC)	Standard
C123	Everest C	No charge
C/CE/E/EF/F/FG/G	Classic Obverse	No charge
Restricted keyway families: KIL or FSIC^{4,5}		
29T	Everest 29 T	\$30.00
D	Everest D	\$30.00
29R	Everest 29 R (Everest SL)	\$30.00
B	Everest B (Everest SL)	\$30.00
Classic Restricted	Quad, Numbered, Reverse	\$30.00
Restricted keyway families: SFIC⁶		
29R	Everest 29 R	No charge
B	Everest B	No charge

4. Full size key systems (Everest 29 S and T, Everest C and D, Obverse and Quad) are available in Primus and Primus XP key system and must be ordered separately. Lock should be ordered less cylinder and Primus cylinder should be a separate line.

5. Everest restricted keyways require a Letter of Authorization to be submitted with the order. See page 302 for sample Letter of Authorization.

6. Master keyed cylinders can be specified and will be shipped in lock packaging. For Master Keying System Summary form which should accompany the master keyed order, see page 296.

PARTS AND ACCESSORIES

OUTSIDE ESCUTCHEON SUBASSEMBLY			Available finishes									
			605	606	612	613	619	622	625	626	643e	626AM
			▪	▪	▪	N/A	▪	N/A	▪	▪	▪	▪
Description	Contents	Specify		Price each								
		Part number	Finish									
Outside escutcheon subassembly (without reader PCBA)	(3) #6-32 x .25 FH PD TC screws (1) Outside RF window assembly (1) Outside backplate	(1) Outside escutcheon (1) Adjustment spring	N223-045	.[Finish]	\$155.00							

INSIDE ESCUTCHEON SUBASSEMBLY			Available finishes									
			605	606	612	613	619	622	625	626	643e	626AM
			▪	▪	▪	N/A	▪	N/A	▪	▪	▪	▪
Description	Contents	Specify		Price each								
		Part number	Finish									
NDEB Inside escutcheon assembly (with main PCBA) - Upgrades NDE80 product	(1) Inside escutcheon (1) Door position sensor (1) Inside label	(1) RF window (1) Main PCB module	47278749	.[Finish]	\$688.00							
Inside battery cover	(1) Battery cover		N623-007	.[Finish]	\$57.00							

READER PCBA		
Description	Specify	Price each
Reader PCBA (Does not support HID secure sector compatibility)	N223-046	\$513.00

BATTERY HOLDER KIT			
Description	Contents	Specify	Price each
Battery holder kit	(1) Battery tray assembly (1) Battery strap	N223-044	\$38.00

LEVERS AND RELATED COMPONENTS			Available finishes									
			605	606	612	613	619	622	625	626	643e	626AM
			▪	▪	▪	N/A	▪	N/A	▪	▪	▪	▪
Description	Specify			Price each								
	Part number	Lever style	Finish									
FSIC Core driver	N523-127	-	.[Finish]	\$4.30								
SFIC Core driver	N523-091	-	.[Finish]	\$17.20								
SFIC Core driver and spacer	09-774	-	.[Finish]	\$21.50								
SFIC Core spacer - Spacer required for 6-pin, no spacer required for 7-pin	D500-000	-	.[Finish]	\$2.50								
New product manufactured on or after February 1, 2017 (reference serial number label on product)												
Lever - Closed; ATH, RHO, SPA, OME, TLR	03-230	.[Lever]	.[Finish]	\$196.00								
Lever - Closed; BAT, 8RO, 8SP, 8TR	03-230	.[Lever]	.[Finish]	\$263.00								
Lever - Cylinder - Schlage KIL; ATH, RHO, SPA	03-231	.[Lever]	.[Finish]	\$196.00								
Lever - Cylinder - Schlage FSIC; ATH, RHO, SPA	03-232	.[Lever]	.[Finish]	\$196.00								
Lever - Cylinder - Schlage SFIC; ATH, RHO, SPA	03-200	.[Lever]	.[Finish]	\$263.00								
Lever - Cylinder - Schlage SFIC - Broadway	47258039	-	.[Finish]	\$199.00								
Lever - Cylinder - Schlage SFIC - Boardwalk	47258040	-	.[Finish]	\$199.00								
Lever - Cylinder - Schlage SFIC - Latitude	47258041	-	.[Finish]	\$199.00								
Lever - Cylinder - Schlage SFIC - Longitude	47258042	-	.[Finish]	\$199.00								
Lever - Cylinder - Schlage SFIC - Broadway (Tactile)	47260537	-	.[Finish]	\$267.00								

PARTS AND ACCESSORIES

LEVERS AND RELATED COMPONENTS	Available finishes									
	605	606	612	613	619	622	625	626	643e	626AM
Description	Specify									
	Part number	Lever style	Finish	Price each						
Lever - Cylinder - Schlage SFIC - Boardwalk (Tactile)	47260538	-	.[Finish]	\$267.00						
Lever - Cylinder - Schlage SFIC - Latitude (Tactile)	47260539	-	.[Finish]	\$267.00						
Lever - Cylinder - Schlage SFIC - Longitude (Tactile)	47260540	-	.[Finish]	\$267.00						
Lever - Closed - Broadway	47258043	-	.[Finish]	\$199.00						
Lever - Closed - Boardwalk	47258044	-	.[Finish]	\$199.00						
Lever - Closed - Latitude	47258045	-	.[Finish]	\$199.00						
Lever - Closed - Longitude	47258046	-	.[Finish]	\$199.00						
Lever - Closed - Broadway (Tactile)	47260541	-	.[Finish]	\$267.00						
Lever - Closed - Boardwalk (Tactile)	47260542	-	.[Finish]	\$267.00						
Lever - Closed - Latitude (Tactile)	47260543	-	.[Finish]	\$267.00						
Lever - Closed - Longitude (Tactile)	47260544	-	.[Finish]	\$267.00						
Lever - P, Z, L - Broadway	47258047	-	.[Finish]	\$199.00						
Lever - P, Z, L - Boardwalk	47258048	-	.[Finish]	\$199.00						
Lever - P, Z, L - Latitude	47258049	-	.[Finish]	\$199.00						
Lever - P, Z, L - Longitude	47258050	-	.[Finish]	\$199.00						
Lever - P, Z, L - Broadway (Tactile)	47260545	-	.[Finish]	\$267.00						
Lever - P, Z, L - Boardwalk (Tactile)	47260546	-	.[Finish]	\$267.00						
Lever - P, Z, L - Latitude (Tactile)	47260547	-	.[Finish]	\$267.00						
Lever - P, Z, L - Longitude (Tactile)	47260548	-	.[Finish]	\$267.00						
Lever FSIC R, J, T - Broadway	47258051	-	.[Finish]	\$199.00						
Lever FSIC R, J, T - Boardwalk	47258052	-	.[Finish]	\$199.00						
Lever FSIC R, J, T - Latitude	47258053	-	.[Finish]	\$199.00						
Lever FSIC R, J, T - Longitude	47258054	-	.[Finish]	\$199.00						
Lever FSIC R, J, T - Broadway (Tactile)	47260549	-	.[Finish]	\$267.00						
Lever FSIC R, J, T - Boardwalk (Tactile)	47260550	-	.[Finish]	\$267.00						
Lever FSIC R, J, T - Latitude (Tactile)	47260551	-	.[Finish]	\$267.00						
Lever FSIC R, J, T - Longitude (Tactile)	47260552	-	.[Finish]	\$267.00						
Original product manufactured before February 1, 2017 (reference serial number label on product)										
Lever - Closed; ATH, RHO, SPA	03-030	.[Lever]	.[Finish]	\$202.00						
Lever - Cylinder - Schlage KIL; ATH, RHO, SPA	03-031	.[Lever]	.[Finish]	\$202.00						
Lever - Cylinder - Schlage FSIC; ATH, RHO, SPA	03-032	.[Lever]	.[Finish]	\$202.00						
Lever - Cylinder - Schlage SFIC; ATH, RHO, SPA	03-000	.[Lever]	.[Finish]	\$202.00						

LE LOCK

NDE LOCK

PARTS AND ACCESSORIES

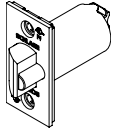
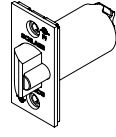
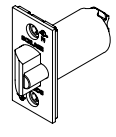
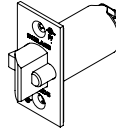
LATCHES AND RELATED COMPONENTS													
14-047 	14-048 	13-247 	14-042 										
Available finishes				605	606	612	613	619	622	625	626	643e	626AM
				▪	▪	▪	N/A	▪	N/A	▪	▪	▪	N/A
DEADLATCH ¹													
Description	Backset	Specify		Price each									
		Part number	Finish										
Square corner, 1-1/8" x 2-1/4"	2-3/8"	14-047	[Finish]	\$80.50									
Square corner, 1" x 2-1/4"	2-3/8"	14-048	[Finish]	\$80.50									
Square corner, 1-1/8" x 2-1/4"	2-3/4"	13-247	[Finish]	\$125.00									
Anti-friction fire door latch 1" square corner, 1-1/8" x 2-1/4", 3/4" throw	2-3/4"	14-042	[Finish]	\$515.00									

¹ All latches require reinforcement when used in hollow metal door applications.

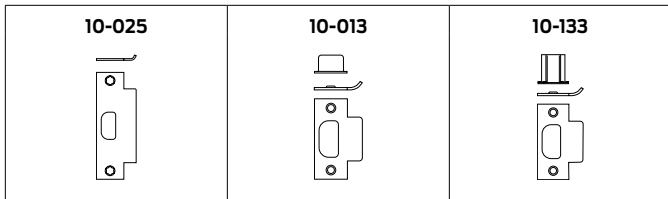

STRIKES			Available finishes										
			605	606	612	613	619	622	625	626	643e	626AM	
			▪	▪	▪	N/A	▪	N/A	▪	▪	▪	N/A	
Description	Contents	Specify		Price each									
		Part number	Finish										
1-3/16" - ANSI, no box, 1-1/4" x 4-7/8"	(1) ANSI strike	10-025	[Finish]	\$21.00									
1-3/16" - ANSI, no box, 1-1/4" x 4-7/8"	(1) ANSI strike (1) ANSI strike magnet tray	(2) C603-256 screws (2) DPS magnet	10-025	[Finish]	\$21.80								
1-3/8" - ANSI, no box, 1-1/4" x 4-7/8"	(1) ANSI strike (1) ANSI strike magnet tray	(2) C603-256 screws (2) DPS magnet	10-130-1316	[Finish]	\$45.00								
1-1/2" - ANSI, no box, 1-1/4" x 4-7/8"	(1) ANSI strike (1) ANSI strike magnet tray	(2) C603-256 screws (2) DPS magnet	10-130-138	[Finish]	\$86.00								
1-3/16" - ANSI, standard box, 1-1/4" x 4-7/8"	(1) ANSI strike (1) ANSI strike magnet tray (1) Standard box	(2) C603-256 screws (2) DPS magnet	10-130-112	[Finish]	\$86.00								
1-3/8" - ANSI, standard box, 1-1/4" x 4-7/8"	(1) ANSI strike (1) ANSI strike magnet tray (1) Standard box	(2) C603-256 screws (2) DPS magnet	10-131-1316	[Finish]	\$57.00								
1-1/2" - ANSI, standard box, 1-1/4" x 4-7/8"	(1) ANSI strike (1) ANSI strike magnet tray (1) Standard box	(2) C603-256 screws (2) DPS magnet	10-131-138	[Finish]	\$98.00								
1-1/8" - Square corner, T-strike, box, 1-1/8" x 2-3/4"	(1) T-strike (1) Standard box	(2) Door position magnet	10-131-112	[Finish]	\$98.00								
1-1/2" - Square corner, T-strike, box, 1-1/8" x 2-3/4"	(1) T-strike (1) Standard box	(2) Door position magnet	10-132-118	[Finish]	\$40.00								
1-1/8" - Square corner, T-strike, deep box, 1-1/8" x 2-3/4" - Use with fire door latch	(1) T-strike (1) Deep box	(2) Door position magnet	10-132-112	[Finish]	\$53.00								

PARTS AND ACCESSORIES

STRIKES		Available finishes									
		605	606	612	613	619	622	625	626	643e	626AM
		▪	▪	▪	N/A	▪	N/A	▪	▪	▪	N/A
Description	Contents	Specify			Price each						
		Part number	Finish								
1-1/2" - Square corner, T-strike, deep box, 1-1/8" x 2-3/4" - Use with fire door latch	(1) T-strike (2) Door position magnet (1) Deep box	10-133-112	.[Finish]		\$48.00						
Box for ANSI strike	(1) Standard box	K510-066	-		\$9.70						

COMPETITOR CORE/COMPATIBILITY PARTS																				
⌘ Extended factory lead time											Available finishes									
											605	606	612	613	619	622	625	626	643e	626AM
											⌘	⌘	⌘	N/A	⌘	N/A	⌘	▪	⌘	N/A
New product manufactured on or after February 1, 2017 (reference serial number label on product)																				
Description	Specify			Price each																
	Part number	Lever style	Finish																	
Lever - Cylinder - Corbin Russwin KIL (L-CO6); ATH, RHO, SPA, TLR	03-234	.[Lever]	.[Finish]	\$361.00																
Lever - Cylinder - Corbin Russwin 7-pin FSIC (J-CO7); RHO	03-235	.[Lever]	.[Finish]	\$361.00																
Lever - Cylinder - Yale 7-pin FSIC (J-YA7); RHO	03-236	-	.[Finish]	\$361.00																
Lever - Cylinder - Medeco 32 (J-MED); ATH, RHO, SPA, TLR	03-237	.[Lever]	.[Finish]	\$361.00																
Lever - Cylinder - Sargent KIL (L-SAR); ATH, RHO, SPA, TLR	03-244	.[Lever]	.[Finish]	\$361.00																
Lever - Cylinder - Medeco 31 or Yale 1210 6-pin FSIC (J-YA6); ATH, RHO, SPA, TLR	03-255	.[Lever]	.[Finish]	\$361.00																
Lever - Cylinder - Corbin Russwin 6-pin FSIC (J-CO6); ATH, RHO, SPA, TLR	03-266	.[Lever]	.[Finish]	\$361.00																
Lever - Cylinder - Sargent FSIC (J-SAR); ATH, RHO, SPA, TLR	03-277	.[Lever]	.[Finish]	\$361.00																
Spring cage and lever catch assembly - Outside standard (P, L, Z, R, J, T, B, BDC, G, H, L-SAR, L-CO6, J-CO6, J-SAR, J-CO7)	N523-218	-	.[Finish]	\$99.50																
Spring cage and lever catch assembly - Outside competitor cores (J-YA6, J-YA7, J-MED)	N523-224	-	.[Finish]	\$207.00																
Tailpiece Sargent XC FSIC	XN12-292	-	.[Finish]	\$18.50																

REINFORCEMENTS (Must be used for hollow metal doors)			
Description	Specify		Price each
	Part number	Door thickness	
Metal door reinforcer kit, fits both 7/8" and 1" diameter housings. Specify door thickness, includes A501-567 and A501-565 or A501-566.	37-001	.[]	\$56.00
Latch spacer – fits 1" diameter latch housing and 1-3/4" hollow metal doors (steel and aluminum)	24483760	-	\$8.00
Reinforcer for 1-3/4" thick non-reinforced metal doors. Fits both 7/8" and 1" diameter housings.	A501-566	-	\$28.30

PARTS AND ACCESSORIES

MOTORIZED CHASSIS ASSEMBLY			
Description	Contents	Specify	Price each
Motorized chassis assembly	(1) NDE Chassis subassembly (1) Main wire harness (1) Motor actuator subassembly	N223-007	\$360.00

TAILPIECES			
Description		Specify	Price each
Core driver - SCH SFIC		N523-091	\$17.20
Core driver - SCH FSIC		N523-127	\$4.30
Core driver - L-SAR		09-060	\$17.20
Core driver - J-YA6		09-061	\$17.20
Core driver - J-CO6		09-062	\$17.20
Core driver - J-SAR		09-063	\$17.20
Core driver - L-CO6		10-140	\$17.20
Core driver - J-CO7		10-141	\$32.90
Core driver - J-YA7		10-142	\$32.90
Core driver - J-MED		10-143	\$32.90
SFIC Core driver and spacer		09-774	\$21.50
SFIC Core spacer - Spacer required for 6-pin, no spacer required for 7-pin		D500-000	\$2.50
Tailpiece Sargent XC SFIC		XN12-292	\$18.50

MAIN WIRE HARNESS			
Description		Specify	Price each
Main wire harness		N223-019	\$55.00

INSIDE BASEPLATE			
Description		Specify	Price each
Inside baseplate		N623-000	\$38.00

New product manufactured on or after February 1, 2017 (reference serial number label on product)

SPRING CAGES			
Description		Specify	Price each
Spring cage and lever catch assembly - Outside standard (P, L, Z, R, J, T, B, BDC, G, H, L-SAR, L-CO6, J-CO6, J-SAR, J-CO7)		N523-218	\$99.50
Spring cage and lever catch assembly - Inside Less Cylinder		N523-221	\$70.00
Spring cage and lever catch assembly - Outside standard (J-YA7, J-YA6, J-MED)		N523-224	\$207.00
Original product manufactured before February 1, 2017 (reference serial number label on product)			
Description		Specify	Price each
Inside spring cage		N123-032	\$74.00
Outside spring cage for all SFIC functions		N123-056	\$108.00
SDS O-Ring - 50 pack		24341463	\$31.00
Door position sensor kit (Includes sensor with wire harness and connector, for NDEB only)		L483-055	\$53.00

PARTS AND ACCESSORIES

CONVERSION KITS	Available finishes										
	605	606	612	613	619	622	625	626	643e	626AM	
	▪	▪	▪	▪	▪	▪	▪	▪	▪	▪	▪
Description	Specify						Price each				
	Part number	Function	Lever	Finish	Core (if applicable)						
Inside spring cage / lever conversion kit	40-400	.[Function]	.[Lever]	.[Finish]	.[Core]	\$317.00					
Outside spring cage / lever conversion kit	40-600	.[Function]	.[Lever]	.[Finish]	.[Core]	\$317.00					

Notes: All kits will contain a spring cage and lever. Some kits will contain a button or tailpiece. Kits are limited to previously offered product - KIL, FSIC, SFIC, L-SAR, J-SAR, J-CO6, J-YA6.

SCREWS				Available finishes										
PH = Phillips head POH machine = Phillips oval head PFH = Phillips flat head				605	606	612	613	619	622	625	626	643e	626AM	
				▪	▪	▪	N/A	▪	N/A	▪	▪	▪	N/A	
Size	Type	Description	Door thickness	Specify		Price each								
				Part number	Finish									
12-24 x 1"	PFH Combo	ANSI strike	-	C603-256	.[Finish]	\$1.40								
#8 x 3/4"	PFH Combo	Latch and strike	-	C603-897	.[Finish]	\$1.30								
#10 x 32 x 2-1/8"	PFH Machine	Spring cage screws	1-3/8" – 2"	N523-021	.[Finish]	\$2.90								

Specify for listed parts (A501-171, L583-133, C603-256, C603-897).

SCREW PACKS				Available finishes										
				605	606	612	613	619	622	625	626	643e	626AM	
				N/A	▪	▪	N/A	▪	N/A	▪	▪	▪	N/A	
Description	Contents	Specify		Price each										
		Part number	Finish											
Latch and strike	(4) C603-897	B202-517	.[Finish]	\$11.80										
ANSI strike	(2) C603-256	C203-736	.[Finish]	\$9.50										
Mounting kit	(4) C603-897 (1) N523-108 (1) N623-048 (2) 96954557 (1) N623-049	N223-049	.[Finish]	\$20.00										

Specify for listed parts (B202-517, C203-736, N123-020).

TORX® SCREW PACKS				Available finishes										
Specify for listed parts (C203-311, C203-312)				605	606	612	613	619	622	625	626	643e	626AM	
				▪	▪	▪	▪	▪	N/A	▪	▪	▪	N/A	
Description	Contents	Specify		Price each										
		Part number	Finish											
Latch and strike ¹	(4) C503-766 (T-15)	C203-311	.[Finish]	\$30.80										
Latch and ANSI strike ¹	(2) C503-766 (T-15) (2) L583-371 (T-20)	N223-049	.[Finish]	\$20.00										

1. Torx screw packs are furnished with appropriate T-xx installation tool(s).

PARTS AND ACCESSORIES

SCHLAGE NDE SERIES Cylinder reference table	Standard			Primus		Primus UL437	
	Part #	Open	Restricted	Part #	Price	Part #	Price
All functions	23-065	\$92.00	\$121.00	20-765	\$199.00	20-565	\$266.00
				20-765-XP	\$199.00	20-565-XP	\$266.00

Available finishes: 606, 626 (Specify for listed parts 23-065, 20-765/XP, 20-565/XP, 21-000).

ENGAGE™ WIRELESS TEST KIT AND ACCESSORIES		
Description	Specify	Price each
TKE - ENGAGE™ Test kit. For use in pre-installation test applications. Comes with 2 TKE Transponders, ENGAGE™ gateway, tripod, TKE gateway bracket, battery, and backpack carry case	47271232	\$2,632.00
TKE Transponder	47269850	\$819.00
TKE Gateway basket (Tripod adapter)	47269870	\$67.00

INSTALLATION TOOLS		
Description	Specify	Price each
Universal clamp (For use with all AD, CO, NDE, and LE Series installation templates)	40-286	See page 178
NDEB Door preparation template (Universal Clamp require to use this template)	47286225	\$924.00
Door position sensor fixture and mounting hardware (47286225 is required to use this fixture)	40-292	\$217.00

Contents

AD Series Networked locks | Overview..... 86
 How to order..... 87
 Class, chassis, exit device compatibility..... 88

AD Series Networked | Functions..... 89

AD Series Networked | Readers..... 90

AD Series Networked | Styles 91

AD Series Networked | Configure a product 92
 Cylinders..... 93
 Key systems..... 94
 Handing..... 94
 Battery..... 94
 Backset and latchbolt (Cylindrical chassis)..... 95
 Mortise lock armor front (Mortise/Mortise deadbolt chassis) 96
 Strike plates (Cylindrical chassis) 97
 Door dimensions 98
 System architecture..... 99

AD-300 Networked hardwired 101
 Cylindrical..... 101
 Mortise/mortise deadbolt 104
 Exit trim..... 107

AD-302 Networked hardwired (FIPS 201-2 Compliant) 110
 Cylindrical..... 110
 Mortise/mortise deadbolt 112
 Exit trim..... 114

AD-400 Networked wireless 116
 Cylindrical..... 116
 Mortise/mortise deadbolt 119
 Exit trim..... 122

AD-402 Networked wireless (FIPS 201-1 Compliant) 125
 Cylindrical..... 125
 Mortise/mortise deadbolt 127
 Exit trim..... 129

AD-993 Non-functioning dummy trim 131

AD Series Networked | Accessories 133

AD Series Networked | Parts..... 179

Finish codes and descriptions

BHMA code	Description
605	Bright brass
606	Satin brass
612	Satin bronze
619	Satin nickel
625	Bright chromium plated
626	Satin chrome
626AM	Satin stainless steel, antimicrobial
643e	Aged bronze



Customer service	Technical support
<ul style="list-style-type: none"> Order status Credit returns of non-defective products General sales questions <p>USA Allegion_Orders@allegion.com CAN Canada.CustomerService@allegion.com</p>	<ul style="list-style-type: none"> Technical questions/issues Returns of defective products Repairs <p>USA Electronic_Lock_TechProdSupport@allegion.com CAN Canada.TechServices@allegion.com</p>

How to order AD Series Networked





		REQUIRED FIELDS		FACTORY DEFAULT AND OPTIONS													
		AD	400	CY	70	MG	SPA	626	P6	S123	RH	4B	13-247	10-025	134	BAA	
1. Series																	
2. Class																	
300	Networked hardwired																
302	Networked hardwired																
400	Networked wireless																
402	Networked wireless																
3. Chassis																	
CY	Cylindrical																
MS	Mortise																
MD	Mortise Deadbolt																
993R	Exit trim - Rim/CVR/CVC																
993S	Exit trim - SVR																
993M	Exit trim - Mortise																
993DT	Dummy Exit trim																
4. Function																	
70	Storeroom	40	Privacy														
50	Office/Classroom	60	Apartment														
5. Reader																	
KP	Keypad																
MGK	Magnetic stripe + keypad (Insert)																
MG	Magnetic stripe (Insert)																
MSK	Magnetic stripe + keypad (Swipe)																
MS	Magnetic stripe (Swipe)																
MTK	Multi-technology + keypad																
MT	Multi-technology																
FMK	FIPS 201-2 Compliant Multi-technology + keypad																
6. Lever¹																	
SPA	Sparta	ATH	Athens														
RHO	Rhodes	TLR	Tubular														
BRW	Broadway	LAT	Latitude														
BRK	Boardwalk	LON	Longitude														
¹ To add tactile warning, use prefix 8. Example: 8SP																	
7. Finish																	
605	Bright Brass	625	Bright Chrome														
606	Satin Brass	626	Satin Chrome														
612	Satin Bronze	643e	Aged Bronze														
619	Satin Nickel	626AM	Satin Chrome (Antimicrobial Coating)														
8. Cylinder type																	
P6	Schlage 6-pin Full Cylinder																
For all options see individual Class/Chassis page																	
9. Keyway type																	
S123	Everest 29																
For all options see individual Class/Chassis page																	
10. Handing																	
RH	Right handed	RHR	Right handed reverse														
LH	Left handed	LHR	Left handed reverse														
11. Battery holder																	
4B	4AA Battery kit	8B	8AA Battery kit														
12. Backset & latch or Armor front																	
13-247	2-3/4" Backset, deadlatch, square corner, 1-1/8" x 2-1/4" (Std. on CY Chassis)																
09-663	Armor Front, 1-1/4" Wide, square corner (Std. on MS Chassis)																
For all options see individual Class/Chassis page																	
13. Strike																	
10-025	1-3/16" Lip, ANSI, no box, 1-1/4" x 4-7/8" (Std. on CY Chassis)																
10-072	1-3/16" Lip, 1-1/4" x 4-7/8" square corner, box (Std. on MS Chassis)																
For all options see individual Class/Chassis page																	
14. Door thickness																	
134	1-3/4" (Std.)																
15. Additional options																	
For all options see individual Class/Chassis page																	

AD SERIES NETWORKED LOCKS

- With the AD Series, one platform translates to an endless number of adaptable solutions. You can choose the features and functions that are right for the application today, and upgrade to meet your evolving needs in the future.

CLASS		
AD-300	Networked/Hardwired; Direct RS-485 connection or Wiegand or Clock & Data	
AD-302	FIPS 201-2 Compliant, Networked Hardwired; Direct RS-485 connection or Wiegand or Clock & Data	
AD-400	Networked/Wireless; 900 MHz, Secure encrypted data transmission	
AD-402	FIPS 201-2 Compliant, Networked Wireless; 900 MHz, Secure encrypted data transmission	

- AD-Series locks are upgradable from standalone to networked by applying a communication module available in the accessories section and new firmware available on www.schlage.com/support.

CHASSIS		
CY: Cylindrical	Bored lock installed into round hole in the door	
MS: Mortise	Lock case installed into a mortise rectangular "pocket" in the door	
MD: Mortise Deadbolt	Mortise lock with built-in interconnected auxiliary deadbolt	
993R: Exit Trim	Rim/Concealed Vertical Rod* (CVR) & Concealed Vertical Cable* (CVC) * Metal door only	
993M: Exit Trim	Mortise	
993S: Exit Trim	Surface Vertical Rod (SVR)	
993DT: Exit Trim	Non-Functioning "Dummy" Exit Trim	

- Mortise Deadbolt requires RS-485 connection to the ACP, see pages 99–100 for system diagram. Check with access control software provider to verify function is enabled.
- Exit trim utilizes universal hardware to simplify installation to a variety of exit device. AD Series networked locks require a Request-to-Exit switch, please see compatibility chart below.

EXIT DEVICE COMPATIBILITY		Exit trim utilizes universal hardware to simplify installation to a variety of exit devices ⁴			
Brand	Compatible exit devices	Rim	SVR	CVR/CVC ⁵	Mortise
Von Duprin	98/99 and 98/99XP	•	•	•	•
Von Duprin	22/22F	•	•		
Falcon	25	•			

- Low current request-to-exit switch is required:
 - Part number for Von Duprin Request-to-Exit switch: 050281
 - Part number for Falcon AE switch: 650359
- Metal door only.







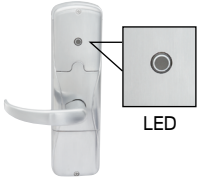
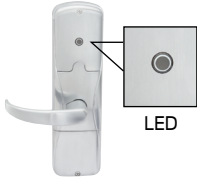
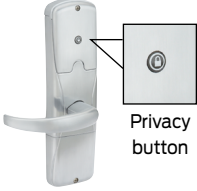
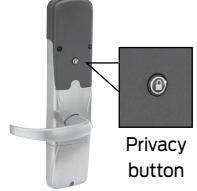

FUNCTIONS

AD-300/302

AD-400/402

FUNCTIONS		AD-300/302	AD-400/402
<p>70: Storeroom</p>	<p>Lockset is normally secure. Inside lever always allows free egress. Valid toggle credentials on the exterior may be used to change to a passage or secured status.</p>	 <p>LED</p>	 <p>LED</p>
<p>50: Office/ Classroom</p>	<p>Lockset is normally secure. Inside lever always allows free egress. Interior pushbutton on inside housing may be used to select a passage or secured status. Meets need for lockdown function for safety and security.</p> <p>NOTE: Valid toggle credentials on the exterior may also be used to change status. Has interior pushbutton (IPB).</p>		
<p>40: Privacy</p>	<p>Lockset is normally secure. Inside lever always allows free egress. Interior pushbutton on inside housing may be used to select a privacy status. The interior pushbutton will disable normal electronic access from the exterior. Opening the door or pressing the interior pushbutton a second time on the inside housing deactivates the privacy status. Has interior pushbutton (IPB).</p>	 <p>Privacy button</p>	 <p>Privacy button</p>
<p>60: Apartment</p>	<p>Lockset is normally secure. Inside lever always allows free egress. Interior pushbutton on inside housing may be used to select a passage or secured status. Opening the door or pressing the interior pushbutton causes the lockset to toggle unsecured. While toggled unsecured, the lockset can only be secured while the door is closed by pressing the interior pushbutton or using a normal credential on the exterior. Normal electronic access from the exterior is always allowed. Has interior pushbutton.</p>		

READER

<p>KP: Keypad</p>	<p>12 button design</p>	
<p>MGK: Magnetic Stripe + Keypad (Insert)</p>	<p>Configurable to read the complete Track 1, 2 or 3. Available with and without 12 button keypad.</p>	
<p>MG: Magnetic Stripe (Insert)</p>		
<p>MSK: Magnetic Stripe + Keypad (Swipe)</p>		
<p>MS: Magnetic Stripe (Swipe)</p>		
<p>MTK: Multi-Technology + Keypad</p>	<p>Single solution that reads 125 kHz proximity and 13.56 MHz smart credentials. Available with and without 12-button keypad</p>	
<p>FMK: FIPS 201-2 Compliant Multi-Technology + Keypad</p>		
<p>MT: Multi-Technology</p>		
<p>Si/SiK: Smart iClass Compatible Reader</p>	<p>13.56 MHz smart card credential solution compatible with Schlage MIFARE, HID iClass, iClass SE, and SEOS technologies. Available with and without 12-button keypad.</p>	

1. Please refer to AD-Series data sheets and solution sheets prior to ordering to verify credential compatibility.
2. FMK reader now sold separately for field upgrades.
3. Must specify finish when ordering reader separately. KP, MGK, MG, MSK & MS readers available in 626, 605, 606, 612, 619, 625 & 643e. MT, MTK & FMK readers are available in Grey (for 619, 626, 626AM & 625) and available in Brown (for 605, 606, 612 & 643e).

LEVER DESIGNS
ATHENS (ATH)²

Tactile option: 8AT (knurled)

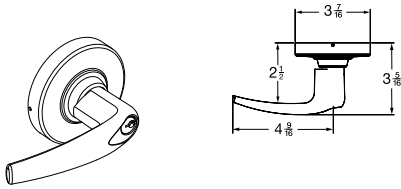
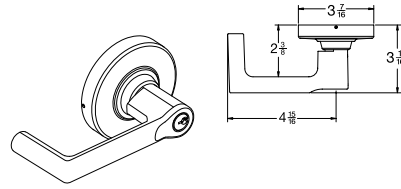
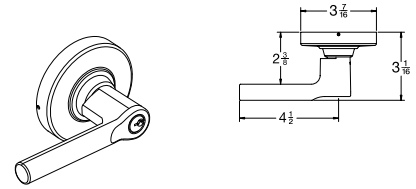
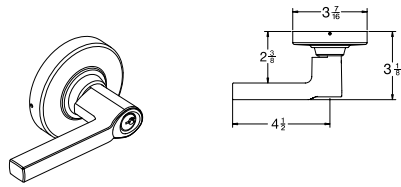
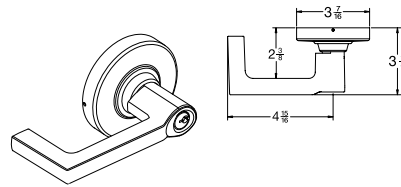
BOARDWALK (BRK)

BROADWAY (BRW)

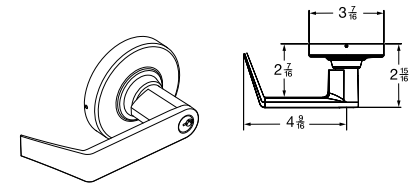
LATITUDE (LAT)

LONGITUDE (LON)

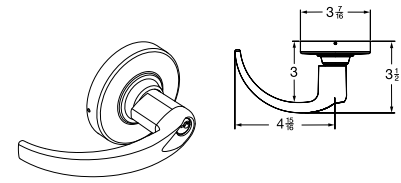
RHODES (RHO)

Tactile option: 8RO (knurled)

SPARTA (SPA)²

Tactile option: 8SP (knurled)

TUBULAR (TLR)²

Tactile option: 8TR (knurled)

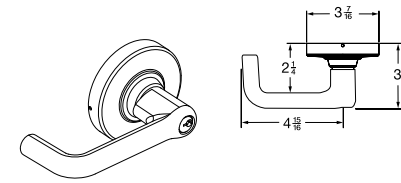

1. All lever designs are available in finishes 605, 606, 612, 619, 625, 626, 643E and 626AM.
2. ATH, SPA, and TLR levers meet California Fire Code for 1/2" or less return to door.
3. Changing lever cylinder compatibility on a device typically requires replacement of existing spring cage and tailpiece.
4. Tactile warning is applied to exterior lever only unless otherwise specified. Not available with 643e finish.
5. AD Series, CO Series, and ND Series levers may be interchangeable in some cases depending whether it is an interior or exterior lever, the type of chassis, and the type of cylinder/spring cage/tailpiece. Please consult the [AD Series Parts Guide](#) for more information.

FINISH CHART

Finish description	Finish No.	BHMA No.	Government
Bright Brass	605	605E	US3
Satin Brass	606	606E	US4
Satin Bronze	612	612E	US10
Satin Nickel	619		
Bright Chrome	625	625E	US26
Satin Chrome	626	626E	US26D
Satin Chrome Antimicrobial	626AM		

 Please refer to the Electronic Access Control catalog or online product information at us.allegion.com to view each finish.

You can **configure and price a full range of products** using the tables and rules shown in this section.

The pricing of locks in this section includes the P6 cylinder in an open keyway (where applicable), default latch, strike and a 1-3/4" thick door. Additional modifications are available using the rules and price adjustments on the subsequent pages.

How to order:

- All applicable product attributes must be provided in the order shown below
- Each value must be separated by a period
- If requesting a product "Less (LLL)" any attribute, the entire detailed ACN must be provided
- Fractions will be written with the "/" symbol separating the numerator and the denominator (example 1/2)
- For dimensions that contain a whole number and a fraction, a hyphen "-" will be added after the whole number and before the fraction (example 2-1/4)
- For two dimensions represented together, such as length and width, the values would be separated by an "x" with no spaces
- Finishes should be listed using their BHMA finish as shown in this book

Required for all lock orders																
Quantity	Brand	Series	Class	Chassis	Function	Reader	Lever style	Finish	Lever cylinder	Keying type	Handling	Battery	Backset & latch or Armor front	Strike	Strike lip length	Door thickness
1	2	3	4	5	6	7	8	9	10	11	12	13	14	15	16	

If ordering a product "Less (LLL)" any attribute, values for each attribute must be provided.

Only required when deviating from the product's default. Specify only the deviated attribute(s).

10-025 standard for Cylindrical, 10-072 standard for Mortise/Mortise Deadbolt

Armor front 09-663 standard for Mortise, 09-666 standard for Mortise Deadbolt

Cover Only standard for AD-300, 4B standard if no selection is made for AD-400

EXAMPLE:

AD . 400 . CY . 70 . **MG** . SPA . 626 . P6 . S123 . RH . 4B

2 | 3 | 4 | 5 | 6 | 7 | 8 | 9 | 10 | 11 | 12

Reader deviates from the product default

COMPLETE LOCKS

CYLINDERS

Keyed locks are priced including the P6 cylinder with open keyway. Provided below are pricing adjustments based on other available cylinder types. For Primus and Primus XP cylinders, order lock less cylinder and order the Primus or Primus XP cylinder separately.

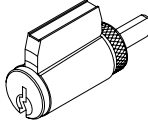
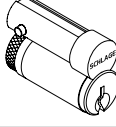
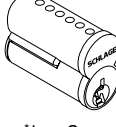
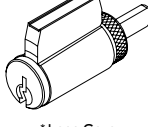
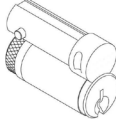
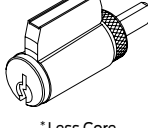
CYLINDERS		
P6	Conventional 6-pin cylinder	
L	Less conventional cylinder	
R	FSIC (Full size interchangeable core)	
J	Less FSIC	
G	SFIC (Small format interchangeable core) 7-pin	 * Less Core
B	Less SFIC	
L-SAR Ⓢ	Less cylinder, Sargent® (10L+11L) 6-pin Key-in-Lever (KIL)	 * Less Core
L-CO6 Ⓢ	Less cylinder, 6-pin Key-in-Lever (KIL)	
J-SAR Ⓢ	Less cylinder, Sargent 6300; 6-pin FSIC	 * Less Core
J-CO6 Ⓢ	Less cylinder, Corbin Russwin® 8000; 6-pin FSIC	
J-CO7 Ⓢ	Less cylinder, Corbin Russwin 8000-7; 7-pin FSIC (Only RHO, 8RO, SPA, 8SP, TLR, 8TR)	
J-MED Ⓢ	Less cylinder, Medeco 32*O201®; 6-pin FSIC	
J-YA6 Ⓢ	Less cylinder, Yale® 1210 or Medeco 31*O100; 6-pin FSIC	
J-YA7 Ⓢ	Less cylinder, Yale 1220; 7-pin FSIC	
L-FA7	Less cylinder, Falcon 7-pin Key-in-Lever (KIL) (Only RHO, 8RO, SPA, 8SP lever styles)	 * Less Core

Ⓢ Extended lead time

1. Competitor lever designs come in finishes 626 standard, and 605, 606, 612, 619, 625, 643e, and 626AM with extended lead-times.
2. For P, R and G -Master Keyed cylinders can be specified and will be shipped in lock packaging.
3. For Master Key System Summary form which should accompany the master keyed order, see pages 296–301.
4. For Master Keying, additional line item 50-210 is required for Classic and Everest cylinders.
5. Control Keys for installation/removal of interchangeable cores are not furnished and must be ordered separate.
6. For additional assistance on Master Keying as well as restricted keyways please contact your local sales representative.
7. Spring cages and tailpieces are different based on the type of cylinder and chassis selected. Please see the [AD Series Parts Guide](#) for more information.
8. The AD Series accepts many popular models of standard, SFIC, and FSIC cylinders. Consult the [Keyway/Cylinder Compatibility Data Sheet](#) (010432) for details. See price book for specific configurations.

COMPLETE LOCKS KEY SYSTEMS

KEY SYSTEMS AVAILABLE THROUGH SCHLAGE		
Default	Keyway family	Description
▪	Everest 29™ S Keyway Family	Patent protected open keyways that are available in full size Key In Lever (KIL) and Full Size Interchangeable Core (FSIC) formats. Patent protection through 2029.
	Everest 29 T Keyway Family	Patent protected restricted keyways that are available in full size KIL and FSIC formats. Patent protection through 2029.
	Everest D Keyway Family	Restricted keyways that are available in full size KIL and FSIC formats.
	Everest C Keyway Family	Open keyways that are available in full size KIL and FSIC formats.
	Schlage Classic Open Keyways	Classic (C/E/F): Open keyways available in KIL and FSIC designs
	Everest B Keyway Family	Restricted keyways that are available on Small Format Interchangeable Core (SFIC).
	Everest 29 R Keyway Family	Patent protected restricted keyways that are available on SFIC. Patent protection through 2029.

- Everest Restricted Keyways require a Letter of Authorization to be submitted with the order. See sample Letter of Authorization on page 302.
 - Full Size key systems (Everest 29 S and T, Everest C and D, Obverse and Quad) are available in Primus and Primus XP key system and must be ordered separately. Lock should be ordered less cylinder and Primus cylinder should be a separate line.
- Contact your local RSO representative for assistance in determining which format and level of exclusivity best suits your needs.

COMPLETE LOCKS HANDING

HANDING		
RH	Right handed: Hinges on right opens inward	
LH	Left handed: Hinges on left opens inward	
RHR	Right handed reverse: Hinges on right opens outward	
LHR	Left handed reverse: Hinges on left opens outward	

- Exit trim 993 chassis available only with RHR or LHR option.
- Handing is field reversible, but requires removal of the exterior escutcheon cover. Please see AD Series installation instructions for details.

COMPLETE LOCKS BATTERY

BATTERY		
4B	4AA Battery holder and cover kit	
8B	8AA Battery holder and cover kit	

AD-300/AD-302 are hardwired and therefore do not require battery power and ship standard with a cover only and no batteries.
 AD-Series locks use standard off-the-shelf AA batteries.

COMPLETE LOCKS

BACKSET AND LATCHBOLT (CYLINDRICAL CHASSIS)

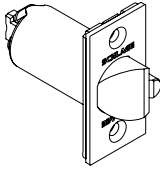
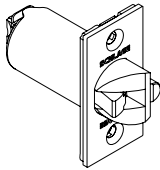
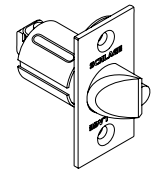
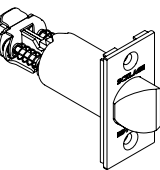
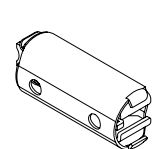
LATCHES		
13-247	2-3/4" Backset Deadlatch Square corner, 1-1/8" x 2-1/4"	
14-049	2-3/4" Backset Deadlatch Anti-friction fire door latch, Square corner, 1-1/8" x 2-1/4", 3/4" throw	
14-051	2-3/8" Backset Deadlatch Square corner, 1-1/8" x 2-1/4"	
14-050	3-3/4" Backset Deadlatch Square corner, 1-1/8" x 2-1/4"	
43-001	5" Backset extension link Deadlatch	
39-030	Rabbeted latch and strike kit, 605 and 626 only. Adapts square corner latch and 2-3/4" square corner strike to 1/2" rabbeted door and frame.	No image available

COMPLETE LOCKS MORTISE LOCK ARMOR FRONT (MORTISE/MORTISE DEADBOLT CHASSIS)

- For 1-3/4" thick doors, use wide armor front. For over 1-3/4" thick door extended equally (EE), use 1-1/4" wide armor front.
- Available finishes are 605, 606, 612, 619, 625, and 626.

ARMOR FRONT		
09-663	1-1/4" Wide square corner, latch for MS	
09-669	1-1/16" Wide square corner, latch, options for MS	
09-666	1-1/4" Wide square corner, latch x deadbolt for MD	
09-672	1-1/16" Wide square corner, latch x deadbolt, options for MD	

Images not shown to scale. Consult [AD Series Parts Guide](#) for more information.

COMPLETE LOCKS

STRIKE PLATES (CYLINDRICAL CHASSIS)

STRIKES WITH LOCKS		
10-025	1-3/16" Lip, ANSI, no box, 1-1/14" x 4-7/8",	
10-013	1-1/8" Lip, square corner, T-strike, box, 1-1/8" – 2-3/4", 1-1/2" Lip available, must specify 1-1/2" Lip	
10-016	1-1/8" Lip, square corner, T-strike, deep box, fire door latch	
K510-066	Box for ANSI strike (Must be specific)	
10-072	1-3/16" Lip, 1-1/4" x 4-7/8", square corner, box	
10-072	7/8", 1", 1-1/2", 1-3/4", or 2" Lip, 1-1/4" x 4-7/8", square corner, box	
10-075	1/2" Rabbeted, For 1-3/4" thick doors, use wide armor front. For over 1-3/4" thick door extended equally (EE) use 1-1/4" wide armor front.	
37-015	Strike frame reinforcer, specify 37-015	
XL11-820	One hole for latching functions, RH & LHR doors Lip 1-3/16"	
XL11-821	One hole for latching functions, LH & RHR doors Lip 1-3/16"	
XQ07-351-134	Strike, ANSI, No Box, 1-1/4" x 4-7/8", 1-3/4" Lip Length	Image not available
XQ03-494-134	Strike, square corner, T-strike, box, 1-1/8" x 2-3/4", 1-3/4" Lip	Image not available

XL11-820 and XL11-821 Extended lead time; contact customer service.



COMPLETE LOCKS DOOR DIMENSIONS

- Specify door thickness on order only if different than 1-3/4" thick door
- Door thickness should be specified to the nearest 1/8"

DOOR THICKNESS	
1-3/4"	1-3/4"
1-3/8"	1-3/8" to 2-3/4", Shims included (Specify in 1/8" increments)

1. Door thickness kits are available on page 194 to install a lock on a door that is thicker or thinner than 1-3/4". See [AD Series Parts Guide](#) for details. Locks cannot be installed on doors thicker than 2-3/4" or thinner than 1-3/8".
2. Thin door shims are available on page 194 to install a lock on a door that is thinner than 1-3/4".
3. Decorative plates are used to cover exposed holes when retrofitting from existing locks to AD Series locks. The size of plate required will vary based on the size and location of holes being covered. Retrofit information can be found at www.schlage.com/support.
4. If under the lock decorative plates are on both sides of device, then door will become 1/8" thicker. A door thickness kit of an incremental 1/8" must be ordered to accommodate under the lock plates.

SYSTEM ARCHITECTURE FOR AD-300 AND AD-400

The AD Series combines all the hardware components required at the door for a complete access control system into one integrated design to simplify installation. This includes the electrified lock, credential reader, request-to-exit and -enter sensors, door position switch, tamper guard and more.

The AD Series is available with flexible hardwired and wireless networked options and can accommodate Wiegand, Clock & Data or RS485 connections to the access control panel or reader interface board.

The following system configurations should be utilized as a guideline for specifying the AD Series. Data sheets with technical specifications are available for download on www.schlage.com/support. We suggest that you consult with your Access Control Provider to verify the specific features, functions and capabilities of the AD Series.

AD-300 NETWORKED HARDWIRED SOLUTION

- Connections other than Wiegand or Clock & Data may incur an additional fee. Consult access control software provides for details.
- PIB300-2D required for Wiegand or Clock & Data connection; supports up to 2 AD-300 devices.

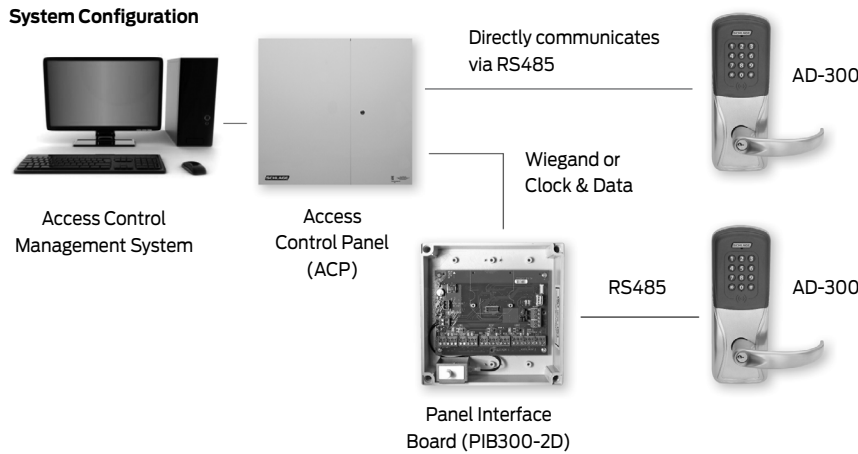

AD-400 NETWORKED WIRELESS SOLUTION

- Connections other than Wiegand or Clock & Data may incur an additional fee. Consult access control software provides for details.
- PIM400-TD2 required for Wiegand or Clock & Data connection; supports up to 2 AD-400 devices.
- If RS485 connection to other ACP is required, contact software provider.

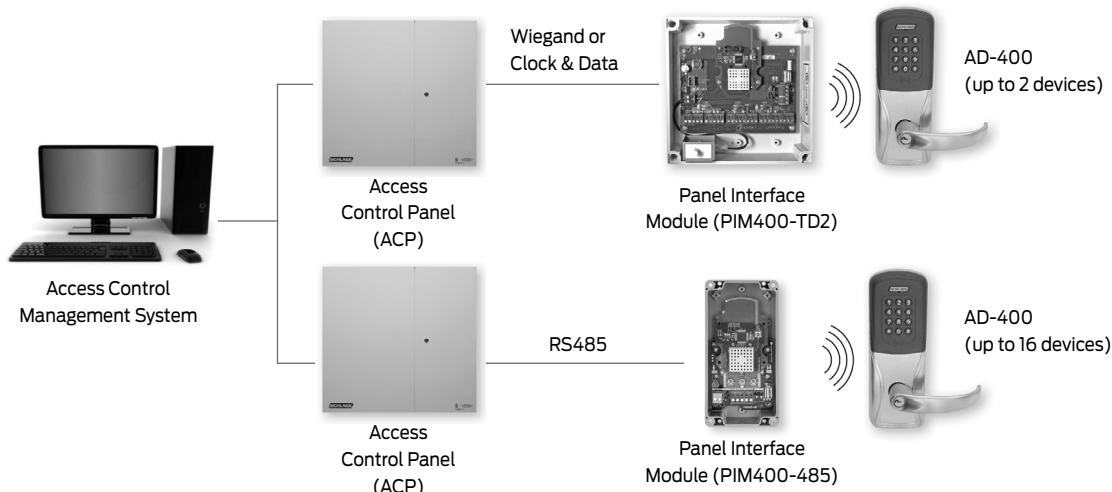

SYSTEM ARCHITECTURE FOR AD-302 AND AD-402

FIPS 201 Overview

- Federal Government Standard for secure and reliable form of identification
- Mandated by Homeland Security Presidential Directive 12 (HSPD 12)
- Required for all Federal Government employees and contractors
- Mandates the type of Smart Card and Card Reader per application
- The WPR401 (wireless portable reader) is available for remote credential verification

In order to meet requirements, the AD Series can either be:

1. Sold as a complete unit with the FMK Multi-technology + keypad reader
2. Field upgraded to a FIPS 201-2 compliant solution by adding the FMK reader (sold separately) and by utilizing the most current firmware available.

AD-302 HARDWIRED FIPS 201-2 COMPLIANT SOLUTION

- RS-485 or Wiegand communication to access control panel (ACP must be FIPS 201-2 compliant)
- FIPS 201-2 Multi-technology reader (FMK)

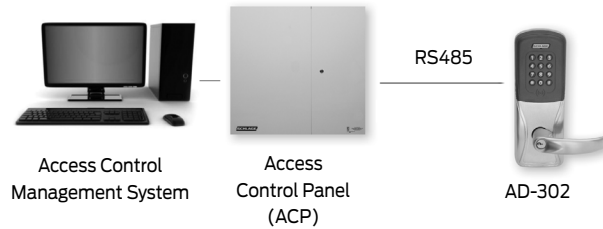

AD-402 WIRELESS FIPS 201-2 COMPLIANT SOLUTION

- 900 MHz communication between lock and PIM400-TD2
- FIPS Multi-technology reader (FMK)
- Connections other than Wiegand or Clock & Data may incur an additional fee. Consult access control software provider for details
- If RS485 connection to ACP is required, contact software provider

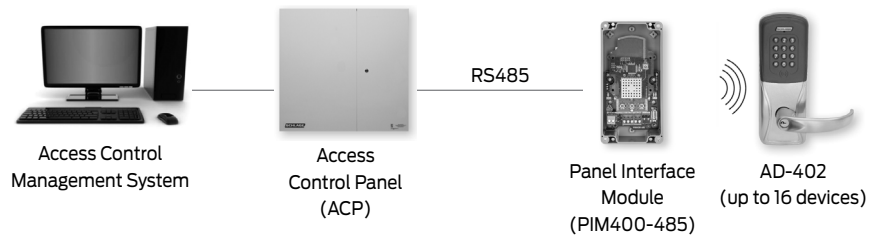

AD-300 NETWORKED HARDWIRED CYLINDRICAL

1-4. Select chassis/function	(Note: Locking function capabilities are determined by users access control system)	Price
AD-300-CY-70 ¹	Storeroom	\$2,499.00
AD-300-CY-50 ^{1,2}	Office/Classroom	\$2,509.00
AD-300-CY-40 ²	Privacy	\$2,509.00
AD-300-CY-60 ²	Apartment	\$2,509.00

1. Less Door Position Switch, use suffix LDP. -\$27.00
2. Requires RS485 connection to ACP. See page 99 for system diagram. Check with access control software provider to verify function is enabled.

5. Select reader	Note: Reflects price adder to base keypad reader price of \$741.00)	Price adjustment
LLL ³	Less Reader	-\$741.00
KP	Keypad	Standard
MS	Magnetic Stripe (Swipe)	\$139.00
MSK	Magnetic Stripe (Swipe) + Keypad	\$229.00
MG	Magnetic Stripe (Insert)	\$160.00
MGK	Magnetic Stripe (Insert) + Keypad	\$255.00
MT	Multi-Technology Proximity and Smart Card	\$275.00
MTK	Multi-Technology + Keypad Proximity and Smart Card	\$364.00
SI	Smart Technology iClass Compatible Reader	\$479.00
SIK	Smart Technology iClass Compatible Reader + Keypad	\$566.00

3. For reader module accessories sold separately, see page 175.
4. FIPS 201-2 Compliant when applied with the FIPS Multi-technology plus keypad reader module (FMK) and by utilizing the most current firmware available. See page 175 for the FMK reader module.

6. Select lever ⁵		Price adjustment
LLL	Less each lever	-\$29.00
Standard options	SPA (Sparta), RHO (Rhodes), ATH (Athens), TLR (Tubular), BRW (Broadway), BRK (Boardwalk), LAT (Latitude), LON (Longitude)	No charge

5. Tactile Warning use 8AT for Athens, 8RO for Rhodes, 8SP for Sparta and 8TR for Tubular. \$64.00 per lever. Applied to exterior lever only unless otherwise specified. Not available with 643e finish.

7. Select finish		Price adjustment
626	Satin Chrome	No charge
605	Bright Brass	\$166.00
606	Satin Brass	\$166.00
612	Satin Bronze (00C rose not available in 612 finish)	\$166.00
619	Satin Nickel	\$166.00
625	Bright Chrome	\$166.00
643e	Aged Bronze	\$166.00
626AM	Satin Chrome Antimicrobial	\$215.00



AD-300-CY-70-MT



KP



MG



MGK



MS



MSK



MT/SI



MTK/SIK/FMK

AD-300 NETWORKED HARDWIRED CYLINDRICAL

8. Select cylinder type		Price adjustment	
		Open	Restricted
<input checked="" type="radio"/> P6	With Cylinder, Schlage - (Everest 29 S123, 6-pin KIL standard)	No charge	\$30.00
L	Less Cylinder, Schlage, Falcon, 6-pin KIL	-\$90.00	-\$90.00
<input type="checkbox"/> R	With Cylinder, Schlage 6-pin (Everest 29 S123 standard) FSIC	\$102.00	\$132.00
J	Less Cylinder, Schlage, 6-pin FSIC	-\$55.00	-\$55.00
<input type="checkbox"/> G	With Cylinder, Schlage 7-pin (Everest 29R standard) (factory master keyed only) SFIC	N/A	\$113.00
B	Less Cylinder, Schlage, Falcon, Competitive OEM's, 7-pin (SFIC)	-\$55.00	-\$55.00
L-SAR	Less Cylinder, Sargent (10L + 11L), 6-pin KIL (Only RHO, 8RO, SPA, 8SP, TLR, 8TR, ATH, 8AT lever styles)	No charge	No charge
L-CO6	Less Cylinder, Corbin, 6-pin KIL (Only RHO, 8RO, SPA, 8SP lever styles)	No charge	No charge
J-SAR	Less Cylinder, Sargent 6300, 6-pin FSIC	No charge	No charge
J-CO6	Less Cylinder, Corbin 8000, 6-pin FSIC	No charge	No charge
J-CO7	Less Cylinder, Corbin 8000-7, 7-pin FSIC, (Only RHO, 8RO, SPA, 8SP, TLR and 8TR)	No charge	No charge
J-MED	Less Cylinder, Medeco 32*0201, 6-pin FSIC (Only RHO, 8RO, SPA, 8SP lever styles)	No charge	No charge
J-YA6	Less Cylinder, Yale 1210 or Medeco 31*0100, 6-pin FSIC	No charge	No charge
J-YA7	Less Cylinder, Yale 1220, 7-pin FSIC (Only RHO, 8RO, SPA, 8SP lever styles)	No charge	No charge
L-FA7	Less Cylinder, Falcon, 7-pin, KIL (Only RHO, 8RO, SPA, 8SP lever styles)	No charge	No charge

● Master Keyed cylinders can be specified and will be shipped in lock packaging. For Master Keying System Summary form which should accompany the master keyed order, see page 296.

△ For master keying, an additional charge of \$28.30 each applies. Specify line item 50-210.

□ Control keys for installation/removal of interchangeable cores are not furnished and must be ordered separate.

For additional assistance on Master Keying as well as restricted keyways, please contact customer service.

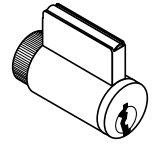

Full Cylinder
P, L, L-SAR, L-FA7

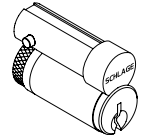

FSIC Format
R, J, J-SAR, J-CO6,
J-CO7, J-YA6

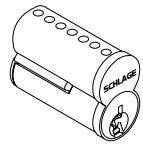

SFIC Format
B, G

9. Select keying type		Price adjustment
Open keyway families: KIL or FSIC⁶		
S123	Everest 29 S (Key in Lever or FSIC)	Standard
C123	Everest C	No charge
C/CE/E/EF/F/FG/G	Classic Obverse	No charge
Restricted keyway families: KIL or FSIC^{6,7}		
29T	Everest 29 T	\$30.00
D	Everest D	\$30.00
Classic Restricted	Quad, Numbered, Reverse	\$30.00
Restricted keyway families: SFIC⁸		
29R	Everest 29 R	No charge
B	Everest B	No charge

6. Full size key systems (Everest 29 S and T, Everest C and D, Obverse and Quad) are available in Primus and Primus XP key system and must be ordered separately. Lock should be ordered less cylinder and Primus cylinder should be a separate line.

7. Everest restricted keyways require a Letter of Authorization to be submitted with the order. See page 302 for sample Letter of Authorization.

8. Master keyed cylinders can be specified and will be shipped in lock packaging. For Master Keying System Summary form which should accompany the master keyed order, see page 296.

10. Select handing (field reversible)		Price adjustment
RH	Right handed	Standard
LH	Left handed	No charge
RHR	Right handed reverse	No charge
LHR	Left handed reverse	No charge



AD-300 NETWORKED HARDWIRED

CYLINDRICAL

11. Select battery		Price adjustment
Cover only	No batteries or holder	Standard

12. Select backset and latch bolt		Price adjustment
LLL	Less Latch	-\$48.00
13-247	2-3/4" Backset, deadlatch, square corner, 1-1/8" x 2-1/4"	Standard
14-049	2-3/4" Backset, Deadlatch Anti-friction fire door latch, Square corner, 1-1/8" x 2-1/4", 3/4" throw	\$254.00
14-051	2-3/8" Backset, deadlatch, square corner, 1-1/8" x 2-1/4"	No charge
14-050	3-3/4" Backset, deadlatch, square corner, 1-1/8" x 2-1/4"	\$15.00
43-001	5" Backset extension link, Deadlatch	\$47.00
39-030 ⁹	Rabbeted latch and strike kit, 605 and 626 only	\$85.00

9. Adapts square corner latch and 2-3/4" square corner strike to 1/2" rabbeted door and frame.

13. Select strike plate		Price adjustment
LLL	Less Strike Plate	-\$6.30
10-025	1-3/16" Lip, ANSI, no box, 1-1/14" x 4-7/8"	Standard
10-013 ¹¹	1-1/8" Lip, square corner, T-strike, box, 1-1/8" - 2-3/4"	No charge
10-016	1-1/8" Lip, square corner, T-strike, deep box, fire door latch	No charge
K510-066	Box for ANSI strike (Must be specific)	No charge

10. 1-1/2" Lip available, must specify 1-1/2" Lip \$9.90.

14. Select door thickness		Price adjustment
134	1-3/4"	Standard
Example 138	1-3/8" to 2-3/4", Shims included (Specify in 1/8" increments)	\$83.00

15. Select options		Price adjustment
BAA ¹¹	BAA Compliant product	\$125.00

11. BAA compliant products must have the cover letter on page 306 included with the order. Failure to use this cover letter will result in the customer receiving non-BAA compliant product with no recourse for an RMA or refund. BAA compliant product requires a longer lead time, please contact customer service for details.

12. Connections other than Wiegand or Clock & Data may incur additional fee. Consult access control software provider for details.

13. Add PIB300-2D if Wiegand or Clock & Data connection to ACP is required. Sold separately. See page 136 for details.

Accessories available, see pages 133–138.

Credentials available, see pages 16–20.

AD-300 NETWORKED HARDWIRED
MORTISE/MORTISE DEADBOLT

1-3. Select chassis		Price
AD-300-MS	Mortise	\$2,871.00
AD-300-MD ²	Mortise Deadbolt	\$2,916.00

4. Select function	Note: Locking function capabilities are determined by users access control system.	Price adjustment
70 ¹	Storeroom (Not available on Mortise Deadbolt)	Standard
50 ^{1,2}	Office/Classroom (Not available on Mortise Deadbolt)	\$10.00
40 ^{2,3}	Privacy	\$10.00
60 ^{2,3}	Apartment	\$10.00

1. Less Door Position Switch, use suffix LDP. -\$27.00
2. Requires RS485 connection to ACP. See page 99 for system diagram. Check with access control software provider to verify function is enabled.
3. Inside Push Button (IPB) only included with Mortise (MS) chassis. Mortise Deadbolt (MD) chassis comes with LED indicator only. \$10.00 charge does not apply to Mortise Deadbolt (MD) chassis.

5. Select reader	Note: Reflects price adder to base keypad reader price of \$741.00	Price adjustment
LLL ⁴	Less Reader	-\$741.00
KP	Keypad	Standard
MS	Magnetic Stripe (Swipe)	\$139.00
MSK	Magnetic Stripe (Swipe) + Keypad	\$229.00
MG	Magnetic Stripe (Insert)	\$160.00
MGK	Magnetic Stripe (Insert) + Keypad	\$255.00
MT	Multi-Technology Proximity and Smart Card	\$275.00
MTK	Multi-Technology + Keypad Proximity and Smart Card	\$364.00
SI	Smart Technology iClass Compatible Reader	\$479.00
SIK	Smart Technology iClass Compatible Reader + Keypad	\$566.00

4. For reader module accessories sold separately, see page 175.
5. FIPS 201-2 Compliant when applied with the FIPS Multi-technology plus keypad reader module (FMK) and by utilizing the most current firmware available. See page 175 for the FMK reader module.

6. Select lever ⁶		Price adjustment
LLL	Less interior and exterior levers	-\$89.60
Standard options	SPA (Sparta), RHO (Rhodes), ATH (Athens), TLR (Tubular), BRW (Broadway), BRK (Boardwalk), LAT (Latitude), LON (Longitude)	No charge

6. Tactile Warning use 8AT for Athens, 8RO for Rhodes, 8SP for Sparta and 8TR for Tubular. \$67.00 per lever. Applied to exterior lever only unless otherwise specified. Not available with 643e finish.

7. Select finish		Price adjustment
626	Satin Chrome	No charge
605	Bright Brass	\$166.00
606	Satin Brass	\$166.00
612	Satin Bronze	\$166.00
619	Satin Nickel	\$166.00
625	Bright Chrome	\$166.00
643e	Aged Bronze	\$166.00
626AM	Satin Chrome Antimicrobial	\$215.00



AD-300-MS-70-MTK



KP



MG



MGK



MS



MSK



MT/SI



MTK/SIK/FMK

AD-300 NETWORKED HARDWIRED
MORTISE/MORTISE DEADBOLT

8. Select cylinder type		Price adjustment	
		Open	Restricted
<input type="checkbox"/> ● P6	With Cylinder, Schlage - (Everest 29 S123, 6-pin KIL standard)	No charge	\$30.00
L	Less Cylinder, Schlage, Falcon, 6-pin KIL	-\$90.00	-\$90.00
<input type="checkbox"/> ● R	With Cylinder, Schlage 6-pin (Everest 29 S123 standard) FSIC	\$102.00	\$132.00
J	Less Cylinder, Schlage, 6-pin FSIC	-\$55.00	-\$55.00
<input type="checkbox"/> ● G	With Cylinder, Schlage 7-pin (Everest 29R standard) (factory master keyed only) SFIC	N/A	\$113.00
B	Less Cylinder, Schlage, Falcon, Competitive OEM's, 7-pin (SFIC)	-\$55.00	-\$55.00
L-SAR	Less Cylinder, Sargent (10L + 11L), 6-pin KIL (Only RHO, 8RO, SPA, 8SP, TLR, 8TR, ATH, 8AT lever styles)	No charge	No charge
L-CO6	Less Cylinder, Corbin, 6-pin KIL (Only RHO, 8RO, SPA, 8SP lever styles)	No charge	No charge
J-SAR	Less Cylinder, Sargent 6300, 6-pin FSIC	No charge	No charge
J-CO6	Less Cylinder, Corbin 8000, 6-pin FSIC	No charge	No charge
J-CO7	Less Cylinder, Corbin 8000-7, 7-pin FSIC, (Only RHO, 8RO, SPA, 8SP, TLR and 8TR)	No charge	No charge
J-MED	Less Cylinder, Medeco 32*0201, 6-pin FSIC (Only RHO, 8RO, SPA, 8SP lever styles)	No charge	No charge
J-YA6	Less Cylinder, Yale 1210 or Medeco 31*0100, 6-pin FSIC	No charge	No charge
J-YA7	Less Cylinder, Yale 1220, 7-pin FSIC (Only RHO, 8RO, SPA, 8SP lever styles)	No charge	No charge
L-FA7	Less Cylinder, Falcon, 7-pin, KIL (Only RHO, 8RO, SPA, 8SP lever styles)	No charge	No charge

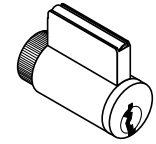
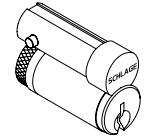
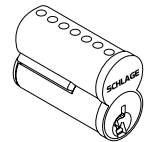
Full Cylinder
P6, L, L-SAR, L-FA7

FSIC Format
R, J, J-SAR, J-CO6, J-CO7, J-YA6

SFIC Format
B, G

● Master Keyed cylinders can be specified and will be shipped in lock packaging. For Master Keying System Summary form which should accompany the master keyed order, see page 296.

△ For master keying, an additional charge of \$28.30 each applies. Specify line item 50-210.

□ Control keys for installation/removal of interchangeable cores are not furnished and must be ordered separate.

For additional assistance on Master Keying as well as restricted keyways, please contact customer service.

9. Select keying type		Price adjustment
Open keyway families: KIL or FSIC⁷		
S123	Everest 29 S (Key in Lever or FSIC)	Standard
C123	Everest C	No charge
C/CE/E/EF/F/FG/G	Classic Obverse	No charge
Restricted keyway families: KIL or FSIC^{7,8}		
29T	Everest 29 T	\$30.00
D	Everest D	\$30.00
Classic Restricted	Quad, Numbered, Reverse	\$30.00
Restricted keyway families: SFIC⁹		
29R	Everest 29 R	No charge
B	Everest B	No charge

7. Full size key systems (Everest 29 S and T, Everest C and D, Obverse and Quad) are available in Primus and Primus XP key system and must be ordered separately. Lock should be ordered less cylinder and Primus cylinder should be a separate line.

8. Everest restricted keyways require a Letter of Authorization to be submitted with the order. See page 302 for sample Letter of Authorization.

9. Master keyed cylinders can be specified and will be shipped in lock packaging. For Master Keying System Summary form which should accompany the master keyed order, see page 296.

10. Select handing (field reversible)		Price adjustment
RH	Right handed	Standard
LH	Left handed	No charge
RHR	Right handed reverse	No charge
LHR	Left handed reverse	No charge



AD-300 NETWORKED HARDWIRED

MORTISE/MORTISE DEADBOLT

11. Select battery		Price adjustment
Cover only	No batteries or holder	Standard

12. Select mortise lock armor front		Price adjustment
LLL	Less Armor Front	-\$23.60
09-663	1-1/4" Wide square corner, latch for MS	Standard
09-669	1-1/16" Wide square corner, Latch, options for MS	No charge
09-666	1-1/4" Wide square corner, latch x deadbolt for MD	Standard
09-672	1-1/16" Wide square corner, latch x deadbolt, options for MD	No charge

13. Select strike plate		Price adjustment
LLL	Less Strike	-\$18.40
10-072	1-1/4" x 4-7/8" Square corner + box; 1-3/16" lip length	Standard
10-072xx	1-1/4" x 4-7/8" Square corner + box; specify lip length (xx) as 1" or 1-1/2"	No charge
10-072xx	1-1/4" x 4-7/8" Square corner + box; specify lip length (xx) as 1-3/4"	\$45.00
10-075 ¹⁰	1/2" Rabbeted	\$155.00
37-015	Strike frame reinforcer, specify 37-015	No charge

10. For 1-3/4" thick doors, use wide armor front. For over 1-3/4" thick door extended equally (EE) use 1-1/4" wide armor front.

¹⁰ Extended lead time, consult customer service.

14. Select door thickness		Price adjustment
134	1-3/4"	Standard
Example 138	1-3/8" to 2-3/4", Shims included (Specify in 1/8" increments)	\$83.00

15. Select options		Price adjustment
BAA ¹¹	BAA Compliant product	\$125.00

11. BAA compliant products must have the cover letter on page 306 included with the order. Failure to use this cover letter will result in the customer receiving non-BAA compliant product with no recourse for an RMA or refund. BAA compliant product requires a longer lead time, please contact customer service for details.

12. Connections other than Wiegand or Clock & Data may incur additional fee. Consult access control software provider for details.

13. Add PIB300-2D if Wiegand or Clock & Data connection to ACP is required. Sold separately. See page 136 for details.

Accessories available, see pages 133–138.

Credentials available, see pages 16–20.

AD-300 NETWORKED HARDWIRED
EXIT TRIM

1-3. Select chassis/trim type (Note: See page 88 for exit device compatibility.) **Price**

AD-300-993R	Exit Rim / Concealed Vertical Rod (Metal Door) / Concealed Vertical Cable (Metal Door)	\$2,940.00
AD-300-993S	Exit Surface Vertical Rod	\$2,975.00
AD-300-993M	Exit Mortise Lock	\$2,975.00

4. Select function (Note: Locking function capabilities are determined by users access control system.) **Price adjustment**

70 ¹	Storeroom	Standard
50 ^{1,2}	Office/Classroom	\$10.00
40 ²	Privacy	\$10.00
60 ²	Apartment	\$10.00

1. Less Door Position Switch, use suffix LDP. -\$27.00

2. Requires RS485 connection to ACP. See page 99 for system diagram. Check with access control software provider to verify function is enabled.

5. Select reader (Note: Reflects price adder to base keypad reader price of \$741.00) **Price adjustment**

LLL ³	Less Reader	-\$741.00
KP	Keypad	Standard
MS	Magnetic Stripe (Swipe)	\$139.00
MSK	Magnetic Stripe (Swipe) + Keypad	\$229.00
MG	Magnetic Stripe (Insert)	\$160.00
MGK	Magnetic Stripe (Insert) + Keypad	\$255.00
MT	Multi-Technology Proximity and Smart Card	\$275.00
MTK	Multi-Technology + Keypad Proximity and Smart Card	\$364.00
SI	Smart Technology iClass Compatible Reader	\$479.00
SIK	Smart Technology iClass Compatible Reader + Keypad	\$566.00

3. For reader module accessories sold separately, see page 175.

4. FIPS 201-2 Compliant when applied with the FIPS Multi-technology plus keypad reader module (FMK) and by utilizing the most current firmware available. See page 175 for the FMK reader module.

6. Select lever⁵ **Price adjustment**

LLL	Less interior and exterior levers	-\$31.00
Standard options	SPA (Sparta), RHO (Rhodes), ATH (Athens), TLR (Tubular), BRW (Broadway), BRK (Boardwalk), LAT (Latitude), LON (Longitude)	No charge

5. Tactile Warning use 8AT for Athens, 8RO for Rhodes, 8SP for Sparta and 8TR for Tubular. \$67.00 per lever. Applied to exterior lever only unless otherwise specified. Not available with 643e finish.

7. Select finish **Price adjustment**

626	Satin Chrome	No charge
605	Bright Brass	\$166.00
606	Satin Brass	\$166.00
612	Satin Bronze	\$166.00
619	Satin Nickel	\$166.00
625	Bright Chrome	\$166.00
643e	Aged Bronze	\$166.00
626AM	Satin Chrome Antimicrobial	\$215.00



AD-300-993R-70-MTK



MG



MGK



MS



MSK



MT/SI



MTK/SIK/FMK

CREDENTIALS

READERS

READER CONTROLLERS

MULTI-FAMILY

ENGAGE

AD SERIES

CO SERIES

ELECTROMAGNETIC LOCKS

POWER SUPPLIES

VON DUPRIN ACCESS CONTROL

SYSTEM ACC

MISC

AD-300 NETWORKED HARDWIRED EXIT TRIM

8. Select cylinder type		Price adjustment	
		Open	Restricted
<input type="checkbox"/> ● P6	With Cylinder, Schlage - (Everest 29 S123, 6-pin KIL standard)	No charge	\$30.00
L	Less Cylinder, Schlage, Falcon, 6-pin KIL	-\$90.00	-\$90.00
<input type="checkbox"/> ● R	With Cylinder, Schlage 6-pin (Everest 29 S123 standard) FSIC	\$102.00	\$132.00
J	Less Cylinder, Schlage, 6-pin FSIC	-\$55.00	-\$55.00
<input type="checkbox"/> ● G	With Cylinder, Schlage 7-pin (Everest 29R standard) (factory master keyed only) SFIC	N/A	\$113.00
B	Less Cylinder, Schlage, Falcon, Competitive OEM's, 7-pin (SFIC)	-\$55.00	-\$55.00
L-SAR	Less Cylinder, Sargent (10L + 11L), 6-pin KIL (Only RHO, 8RO, SPA, 8SP, TLR, 8TR, ATH, 8AT lever styles)	No charge	No charge
L-CO6	Less Cylinder, Corbin, 6-pin KIL (Only RHO, 8RO, SPA, 8SP lever styles)	No charge	No charge
J-SAR	Less Cylinder, Sargent 6300, 6-pin FSIC	No charge	No charge
J-CO6	Less Cylinder, Corbin 8000, 6-pin FSIC	No charge	No charge
J-CO7	Less Cylinder, Corbin 8000-7, 7-pin FSIC, (Only RHO, 8RO, SPA, 8SP, TLR and 8TR)	No charge	No charge
J-MED	Less Cylinder, Medeco 32*0201, 6-pin FSIC (Only RHO, 8RO, SPA, 8SP lever styles)	No charge	No charge
J-YA6	Less Cylinder, Yale 1210 or Medeco 31*0100, 6-pin FSIC	No charge	No charge
J-YA7	Less Cylinder, Yale 1220, 7-pin FSIC (Only RHO, 8RO, SPA, 8SP lever styles)	No charge	No charge
L-FA7	Less Cylinder, Falcon, 7-pin, KIL (Only RHO, 8RO, SPA, 8SP lever styles)	No charge	No charge

● Master Keyed cylinders can be specified and will be shipped in lock packaging. For Master Keying System Summary form which should accompany the master keyed order, see page 296.

△ For master keying, an additional charge of \$28.30 each applies. Specify line item 50-210.

□ Control keys for installation/removal of interchangeable cores are not furnished and must be ordered separate.

For additional assistance on Master Keying as well as restricted keyways, please contact customer service.

9. Select keying type		Price adjustment
Open keyway families: KIL or FSIC⁶		
S123	Everest 29 S (Key in Lever or FSIC)	Standard
C123	Everest C	No charge
C/CE/E/EF/F/FG/G	Classic Obverse	No charge
Restricted keyway families: KIL or FSIC^{6,7}		
29T	Everest 29 T	\$30.00
D	Everest D	\$30.00
Classic Restricted	Quad, Numbered, Reverse	\$30.00
Restricted keyway families: SFIC⁸		
29R	Everest 29 R	No charge
B	Everest B	No charge

6. Full size key systems (Everest 29 S and T, Everest C and D, Obverse and Quad) are available in Primus and Primus XP key system and must be ordered separately. Lock should be ordered less cylinder and Primus cylinder should be a separate line.

7. Everest restricted keyways require a Letter of Authorization to be submitted with the order. See page 302 for sample Letter of Authorization.

8. Master keyed cylinders can be specified and will be shipped in lock packaging. For Master Keying System Summary form which should accompany the master keyed order, see page 296.

10. Select handing (field reversible)		Price adjustment
RH	Right handed	Standard
LH	Left handed	No charge
RHR	Right handed reverse	No charge
LHR	Left handed reverse	No charge

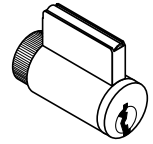

Full Cylinder
P6, L, L-SAR, L-FA7

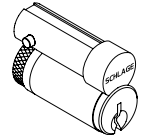

FSIC Format
R, J, J-SAR, J-CO6,
J-CO7, J-YA6

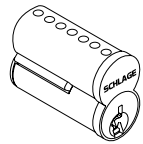

SFIC Format
B, G



AD-300 NETWORKED HARDWIRED EXIT TRIM

11. Select battery		Price adjustment
Cover only	No batteries or holder	Standard

12. – 13. No selection required

14. Select door thickness		Price adjustment
134	1-3/4"	Standard
Example 200	1-3/4" to 2-3/4", (Specify in 1/8" increments)	\$83.00

15. Select options		Price adjustment
LRX	Less Von Duprin low current Request-To-Exit switch	-\$73.00
BAA ⁹	BAA Compliant product	\$125.00

- 9. BAA compliant products must have the cover letter on page 306 included with the order. Failure to use this cover letter will result in the customer receiving non-BAA compliant product with no recourse for an RMA or refund. BAA compliant product requires a longer lead time, please contact customer service for details.
- 10. Connections other than Wiegand or Clock & Data may incur additional fee. Consult access control software provider for details.
- 11. Add PIB300-2D if Wiegand or Clock & Data connection to ACP is required. Sold separately. See page 136 for details.
- 12. AD-300 Exit trim comes with a universal mounting plate and is compatible with Von Duprin Series 98/99, 98/99XP, 22/22F exit devices and Falcon 25 rim exit devices with proper low current Request-To-Exit switch (RX-LC). Concealed Vertical Rod and Concealed Vertical Cable trim on metal door only. **When Request-to-exit is required, the Von Duprin RX-LC switch (part #050281) or Falcon AE switch (part #650359) must be used or the Warranty is void.**

Accessories available, see pages 133–138.

Credentials available, see pages 16–20.

AD Series Non-Functioning "Dummy" Exit trim now available. Please see pages 131–132 for details.

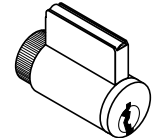
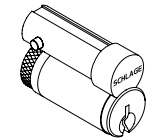
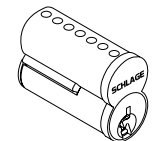

AD-302 NETWORKED HARDWIRED CYLINDRICAL (FIPS 201-2 COMPLIANT)

AD-302-CY-70-FMK

Full Cylinder
 P6, L, L-SAR, L-FA7

FSIC Format
 R, J, J-SAR, J-CO6,
 J-CO7, J-YA6

SFIC Format
 B, G

1-4. Select chassis/function (Note: Locking function capabilities are determined by users access control system.)		Price
AD-302-CY-70 ¹	Storeroom	\$2,499.00
AD-302-CY-50 ¹	Office/Classroom	\$2,509.00
AD-302-CY-40 ²	Privacy	\$2,509.00
AD-302-CY-60 ²	Apartment	\$2,509.00

1. Less Door Position Switch, use suffix LDP. -\$27.00
2. Requires RS485 connection to ACP. See page 100 for system diagram. Check with Access Control software provider to verify function is enabled.

5. Select reader		Price adjustment
FMK	FIPS 201-2 Multi-Technology + Keypad Proximity and Smart Card (PIV and PIV-I Card)	\$664.00

The AD-300 lock can be field upgraded to a FIPS 201-2 compliant solution simply by adding the FMK reader (sold separately) and by using the most current firmware revision.

Verify compatibility of PIV and PIV-I credentials with access control software provider.

6. Select lever ³		Price adjustment
LLL	Less each lever	-\$31.00
Standard options	SPA (Sparta), RHO (Rhodes), ATH (Athens), TLR (Tubular), BRW (Broadway), BRK (Boardwalk), LAT (Latitude), LON (Longitude)	No charge

3. Tactile Warning use 8AT for Athens, 8RO for Rhodes, 8SP for Sparta and 8TR for Tubular. \$67.00 per lever. Applied to exterior lever only unless otherwise specified. Not available with 643e finish.

7. Select finish		Price adjustment
626	Satin Chrome	No charge
605	Bright Brass	\$166.00
606	Satin Brass	\$166.00
612	Satin Bronze	\$166.00
619	Satin Nickel	\$166.00
625	Bright Chrome	\$166.00
643e	Aged Bronze	\$166.00
626AM	Satin Chrome Antimicrobial	\$215.00

8. Select cylinder type		Price adjustment	
		Open	Restricted
△ ● P6	With Cylinder, Schlage - (Everest 29 S123, 6-pin KIL standard)	No charge	\$30.00
L	Less Cylinder, Schlage, Falcon, 6-pin KIL	-\$90.00	-\$90.00
□ ● R	With Cylinder, Schlage 6-pin (Everest 29 S123 standard) FSIC	\$102.00	\$132.00
J	Less Cylinder, Schlage, 6-pin FSIC	-\$55.00	-\$55.00
□ ● G	With Cylinder, Schlage 7-pin (Everest 29R standard) (factory master keyed only) SFIC	N/A	\$113.00
B	Less Cylinder, Schlage, Falcon, Competitive OEM's, 7-pin (SFIC)	-\$55.00	-\$55.00
L-SAR	Less Cylinder, Sargent (10L + 11L), 6-pin KIL (Only RHO, 8RO, SPA, 8SP, TLR, 8TR, ATH, 8AT lever styles)	No charge	No charge
L-CO6	Less Cylinder, Corbin, 6-pin KIL (Only RHO, 8RO, SPA, 8SP lever styles)	No charge	No charge
J-SAR	Less Cylinder, Sargent 6300, 6-pin FSIC	No charge	No charge
J-CO6	Less Cylinder, Corbin 8000, 6-pin FSIC	No charge	No charge
J-CO7	Less Cylinder, Corbin 8000-7, 7-pin FSIC, (Only RHO, 8RO, SPA, 8SP, TLR and 8TR)	No charge	No charge
J-MED	Less Cylinder, Medeco 32*0201, 6-pin FSIC (Only RHO, 8RO, SPA, 8SP lever styles)	No charge	No charge
J-YA6	Less Cylinder, Yale 1210 or Medeco 31*0100, 6-pin FSIC	No charge	No charge
J-YA7	Less Cylinder, Yale 1220, 7-pin FSIC (Only RHO, 8RO, SPA, 8SP lever styles)	No charge	No charge
L-FA7	Less Cylinder, Falcon, 7-pin, KIL (Only RHO, 8RO, SPA, 8SP lever styles)	No charge	No charge

- Master Keyed cylinders can be specified and will be shipped in lock packaging. For Master Keying System Summary form which should accompany the master keyed order, see page 296.

△ For master keying, an additional charge of \$28.30 each applies. Specify line item 50-210.

□ Control keys for installation/removal of interchangeable cores are not furnished and must be ordered separate.

For additional assistance on Master Keying as well as restricted keyways, please contact customer service.

AD-302 NETWORKED HARDWIRED

CYLINDRICAL (FIPS 201-2 COMPLIANT)

9. Select keying type		Price adjustment
Open keyway families: KIL or FSIC⁴		
S123	Everest 29 S (Key in Lever or FSIC)	Standard
C123	Everest C	No charge
C/CE/E/EF/F/FG/G	Classic Obverse	No charge
Restricted keyway families: KIL or FSIC^{4,5}		
29T	Everest 29 T	\$30.00
D	Everest D	\$30.00
Classic Restricted	Quad, Numbered, Reverse	\$30.00
Restricted keyway families: SFIC⁶		
29R	Everest 29 R	No charge
B	Everest B	No charge

- Full size key systems (Everest 29 S and T, Everest C and D, Obverse and Quad) are available in Primus and Primus XP key system and must be ordered separately. Lock should be ordered less cylinder and Primus cylinder should be a separate line.
- Everest restricted keyways require a Letter of Authorization to be submitted with the order. See page 302 for sample Letter of Authorization.
- Master keyed cylinders can be specified and will be shipped in lock packaging. For Master Keying System Summary form which should accompany the master keyed order, see page 296.

10. Select handing (field reversible)		Price adjustment
RH	Right handed	Standard
LH	Left handed	No charge
RHR	Right handed reverse	No charge
LHR	Left handed reverse	No charge

11. Select battery		Price adjustment
Cover only	No batteries or holder	Standard

12. Select backset and latch bolt		Price adjustment
LLL	Less Latch	-\$48.00
13-247	2-3/4" Backset, deadlatch, square corner, 1-1/8" x 2-1/4"	Standard
14-049	2-3/4" Backset, deadlatch anti-friction fire door latch, square corner, 1-1/8" x 2-1/4", 3/4" throw	\$254.00
14-051	2-3/8" Backset, deadlatch, square corner, 1-1/8" x 2-1/4"	No charge
14-050	3-3/4" Backset, deadlatch, square corner, 1-1/8" x 2-1/4"	\$15.00
43-001	5" Backset extension link, deadlatch	\$47.00
39-030 ⁷	Rabbeted latch and strike kit, 605 and 626 only	\$85.00

- Adapts square corner latch and 2-3/4" square corner strike to 1/2" rabbeted door and frame.

13. Select strike plate		Price adjustment
LLL	Less Strike Plate	-\$6.30
10-025	1-3/16" Lip, ANSI, no box, 1-1/14" x 4-7/8"	Standard
10-013 ⁸	1-1/8" Lip, square corner, T-strike, box, 1-1/8" - 2-3/4"	No charge
10-016	1-1/8" Lip, square corner, T-strike, deep box, fire door latch	No charge
K510-066	Box for ANSI strike (Must be specific)	No charge

- 1-1/2" Lip available, must specify 1-1/2" Lip \$9.90.

14. Select door thickness		Price adjustment
134	1-3/4"	Standard
Example 138	1-3/8" to 2-3/4", Shims included (Specify in 1/8" increments)	\$83.00

15. Select options		Price adjustment
BAA ⁹	BAA Compliant product	\$125.00

- BAA compliant products must have the cover letter on page 306 included with the order. Failure to use this cover letter will result in the customer receiving non-BAA compliant product with no recourse for an RMA or refund. BAA compliant product requires a longer lead time, please contact customer service for details.
- Connections other than Wiegand or Clock & Data may incur additional fee. Consult access control software provider for details.
- Add PIB300-2D if Wiegand or Clock & Data connection to ACP is required. Sold separately. See page 136 for details. Standard accessories sold separately available, see pages 133-138.

AD-302 NETWORKED HARDWIRED
MORTISE/MORTISE DEADBOLT (FIPS 201-2 COMPLIANT)

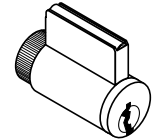
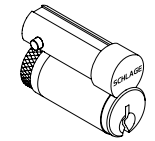
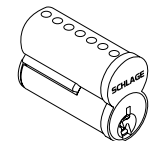
AD-302-MS-70-FMK

**Full Cylinder
P6, L, L-SAR, L-FA7**

**FSIC Format
R, J, J-SAR, J-CO6,
J-CO7, J-YA6**

**SFIC Format
B, G**

1-3. Select chassis		Price
AD-302-MS	Mortise	\$2,871.00
AD-302-MD ²	Mortise Deadbolt	\$2,916.00

4. Select function	(Note: Locking function capabilities are determined by users access control system.)	Price adjustment
70 ¹	Storeroom (Not available on Mortise Deadbolt)	Standard
50 ^{1,2}	Office/Classroom (Not available on Mortise Deadbolt)	\$10.00
40 ^{2,3}	Privacy	\$10.00
60 ^{2,3}	Apartment	\$10.00

1. Less Door Position Switch, use suffix LDP. -\$27.00
2. Requires RS485 connection to ACP. See page 100 for system diagram. Check with access control software provider to verify function is enabled.
3. Inside Push Button (IPB) only included with Mortise (MS) chassis. Mortise Deadbolt (MD) chassis comes with LED indicator only. \$10.00 charge does not apply to Mortise Deadbolt (MD) chassis.

5. Select reader		Price adjustment
FMK	FIPS 201-2 Multi-Technology + Keypad Proximity and Smart Card (PIV and PIV-I Card)	\$664.00

The AD-300 lock can be field upgraded to a FIPS 201-2 compliant solution simply by adding the FMK reader (sold separately) and by using the most current firmware revision.

Verify compatibility of PIV and PIV-I credentials with access control software provider.

6. Select lever ⁴		Price adjustment
LLL	Less interior and exterior levers	-\$89.60
Standard options	SPA (Sparta), RHO (Rhodes), ATH (Athens), TLR (Tubular), BRW (Broadway), BRK (Boardwalk), LAT (Latitude), LON (Longitude)	No charge

4. Tactile Warning use 8AT for Athens, 8RO for Rhodes, 8SP for Sparta and 8TR for Tubular. \$67.00 per lever. Applied to exterior lever only unless otherwise specified. Not available with 643e finish.

7. Select finish		Price adjustment
626	Satin Chrome	No charge
605	Bright Brass	\$166.00
606	Satin Brass	\$166.00
612	Satin Bronze	\$166.00
619	Satin Nickel	\$166.00
625	Bright Chrome	\$166.00
643e	Aged Bronze	\$166.00
626AM	Satin Chrome Antimicrobial	\$215.00

8. Select cylinder type		Price adjustment	
		Open	Restricted
<input type="checkbox"/> ● P6	With Cylinder, Schlage - (Everest 29 S123, 6-pin KIL standard)	No charge	\$30.00
	L Less Cylinder, Schlage, Falcon, 6-pin KIL	-\$90.00	-\$90.00
<input type="checkbox"/> ● R	With Cylinder, Schlage 6-pin (Everest 29 S123 standard) FSIC	\$102.00	\$132.00
	J Less Cylinder, Schlage, 6-pin FSIC	-\$55.00	-\$55.00
<input type="checkbox"/> ● G	With Cylinder, Schlage 7-pin (Everest 29R standard) (factory master keyed only) SFIC	N/A	\$113.00
	B Less Cylinder, Schlage, Falcon, Competitive OEM's, 7-pin (SFIC)	-\$55.00	-\$55.00
	L-SAR Less Cylinder, Sargent (10L + 11L), 6-pin KIL (Only RHO, 8RO, SPA, 8SP, TLR, 8TR, ATH, 8AT lever styles)	No charge	No charge
	L-CO6 Less Cylinder, Corbin, 6-pin KIL (Only RHO, 8RO, SPA, 8SP lever styles)	No charge	No charge
	J-SAR Less Cylinder, Sargent 6300, 6-pin FSIC	No charge	No charge
	J-CO6 Less Cylinder, Corbin 8000, 6-pin FSIC	No charge	No charge
	J-CO7 Less Cylinder, Corbin 8000-7, 7-pin FSIC, (Only RHO, 8RO, SPA, 8SP, TLR and 8TR)	No charge	No charge
	J-MED Less Cylinder, Medeco 32*0201, 6-pin FSIC (Only RHO, 8RO, SPA, 8SP lever styles)	No charge	No charge
	J-YA6 Less Cylinder, Yale 1210 or Medeco 31*0100, 6-pin FSIC	No charge	No charge
	J-YA7 Less Cylinder, Yale 1220, 7-pin FSIC (Only RHO, 8RO, SPA, 8SP lever styles)	No charge	No charge
	L-FA7 Less Cylinder, Falcon, 7-pin, KIL (Only RHO, 8RO, SPA, 8SP lever styles)	No charge	No charge

● Master Keyed cylinders can be specified and will be shipped in lock packaging. For Master Keying System Summary form which should accompany the master keyed order, see page 296.

△ For master keying, an additional charge of \$28.30 each applies. Specify line item 50-210.

Control keys for installation/removal of interchangeable cores are not furnished and must be ordered separate.

For additional assistance on Master Keying as well as restricted keyways, please contact customer service.

AD-302 NETWORKED HARDWIRED

MORTISE/MORTISE DEADBOLT (FIPS 201-2 COMPLIANT)

9. Select keying type		Price adjustment
Open keyway families: KIL or FSIC⁵		
S123	Everest 29 S (Key in Lever or FSIC)	Standard
C123	Everest C	No charge
C/CE/E/EF/F/FG/G	Classic Obverse	No charge
Restricted keyway families: KIL or FSIC^{5,6}		
29T	Everest 29 T	\$30.00
D	Everest D	\$30.00
Classic Restricted	Quad, Numbered, Reverse	\$30.00
Restricted keyway families: SFIC⁷		
29R	Everest 29 R	No charge
B	Everest B	No charge

- Full size key systems (Everest 29 S and T, Everest C and D, Obverse and Quad) are available in Primus and Primus XP key system and must be ordered separately. Lock should be ordered less cylinder and Primus cylinder should be a separate line.
- Everest restricted keyways require a Letter of Authorization to be submitted with the order. See page 302 for sample Letter of Authorization.
- Master keyed cylinders can be specified and will be shipped in lock packaging. For Master Keying System Summary form which should accompany the master keyed order, see page 296.

10. Select handing (field reversible)		Price adjustment
RH	Right handed	Standard
LH	Left handed	No charge
RHR	Right handed reverse	No charge
LHR	Left handed reverse	No charge

11. Select battery		Price adjustment
Cover only	No batteries or holder	Standard

12. Select mortise lock armor front		Price adjustment
LLL	Less Armor Front	-\$23.60
09-663	1-1/4" Wide square corner, latch for MS	Standard
09-669	1-1/16" Wide square corner, Latch, options for MS	No charge
09-666	1-1/4" Wide square corner, latch x deadbolt for MD	Standard
09-672	1-1/16" Wide square corner, latch x deadbolt, options for MD	No charge

13. Select strike plate		Price adjustment
LLL	Less Strike	-\$18.40
10-072	1-1/4" x 4-7/8" Square corner + box; 1-3/16" lip length	Standard
10-072xx	1-1/4" x 4-7/8" Square corner + box; specify lip length (xx) as 1" or 1-1/2"	No charge
10-072xx	1-1/4" x 4-7/8" Square corner + box; specify lip length (xx) as 1-3/4"	\$45.00
10-075 ^a	1/2" Rabbeted	\$155.00
37-015	Strike frame reinforcer, specify 37-015	No charge

- For 1-3/4" thick doors, use wide armor front. For over 1-3/4" thick door extended equally (EE) use 1-1/4" wide armor front.
- ^a Extended lead time, consult customer service.

14. Select door thickness		Price adjustment
134	1-3/4"	Standard
Example 138	1-3/8" to 2-3/4", Shims included (Specify in 1/8" increments)	\$83.00

15. Select options		Price adjustment
BAA ⁹	BAA Compliant product	\$125.00

- BAA compliant products must have the cover letter on page 306 included with the order. Failure to use this cover letter will result in the customer receiving non-BAA compliant product with no recourse for an RMA or refund. BAA compliant product requires a longer lead time, please contact customer service for details.
- Connections other than Wiegand or Clock & Data may incur additional fee. Consult access control software provider for details.
- Add PIB300-2D if Wiegand or Clock & Data connection to ACP is required. Sold separately. See page 136 for details.

Accessories including Panel Interface Board (PIB300-2D) Decorative plates, US A-KIT, etc. available, see pages 133-138.

AD-302 NETWORKED HARDWIRED EXIT TRIM (FIPS 201-2 COMPLIANT)

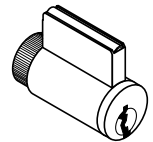
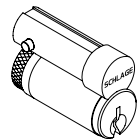
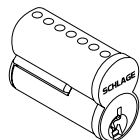
AD-302-993R-70-FMK

**Full Cylinder
P6, L, L-SAR, L-FA7**

**FSIC Format
R, J, J-SAR, J-CO6,
J-CO7, J-YA6**

**SFIC Format
B, G**

1-3. Select chassis/exit trim type (Note: See page 88 for exit device compatibility.)		Price
AD-302-993R	Exit Rim / Concealed Vertical Rod (Metal Door) / Concealed Vertical Cable (Metal Door)	\$2,940.00
AD-302-993S	Exit Surface Vertical Rod	\$2,975.00
AD-302-993M	Exit Mortise Lock	\$2,975.00

4. Select function (Note: Locking function capabilities are determined by users access control system)		Price adjustment
70 ¹	Storeroom	Standard
50 ^{1,2}	Office/Classroom	\$10.00
40 ²	Privacy	\$10.00
60 ²	Apartment	\$10.00

1. Less Door Position Switch, use suffix LDP. -\$27.00
2. Requires RS485 connection to ACP. See page 100 for system diagram. Check with access control software provider to verify function is enabled.

5. Select reader		Price adjustment
FMK	FIPS 201-2 Multi-Technology + Keypad Proximity and Smart Card (PIV and PIV-I Card)	\$664.00

The AD-300 lock can be field upgraded to a FIPS 201-2 compliant solution simply by adding the FMK reader (sold separately) and by using the most current firmware revision.

Verify compatibility of PIV and PIV-I credentials with access control software provider.

6. Select lever ³		Price adjustment
LLL	Less interior and exterior levers	-\$31.00
Standard options	SPA (Sparta), RHO (Rhodes), ATH (Athens), TLR (Tubular), BRW (Broadway), BRK (Boardwalk), LAT (Latitude), LON (Longitude)	No charge

3. Tactile Warning use 8AT for Athens, 8RO for Rhodes, 8SP for Sparta and 8TR for Tubular. \$67.00 per lever. Applied to exterior lever only unless otherwise specified. Not available with 643e finish.

7. Select finish		Price adjustment
626	Satin Chrome	No charge
605	Bright Brass	\$166.00
606	Satin Brass	\$166.00
612	Satin Bronze	\$166.00
619	Satin Nickel	\$166.00
625	Bright Chrome	\$166.00
643e	Aged Bronze	\$166.00
626AM	Satin Chrome Antimicrobial	\$215.00

8. Select cylinder type		Price adjustment	
		Open	Restricted
△ ● P6	With Cylinder, Schlage - (Everest 29 S123, 6-pin KIL standard)	No charge	\$30.00
L	Less Cylinder, Schlage, Falcon, 6-pin KIL	-\$90.00	-\$90.00
□ ● R	With Cylinder, Schlage 6-pin (Everest 29 S123 standard) FSIC	\$102.00	\$132.00
J	Less Cylinder, Schlage, 6-pin FSIC	-\$55.00	-\$55.00
□ ● G	With Cylinder, Schlage 7-pin (Everest 29R standard) (factory master keyed only) SFIC	N/A	\$113.00
B	Less Cylinder, Schlage, Falcon, Competitive OEM's, 7-pin (SFIC)	-\$55.00	-\$55.00
L-SAR	Less Cylinder, Sargent (10L + 11L), 6-pin KIL (Only RHO, 8RO, SPA, 8SP, TLR, 8TR, ATH, 8AT lever styles)	No charge	No charge
L-CO6	Less Cylinder, Corbin, 6-pin KIL (Only RHO, 8RO, SPA, 8SP lever styles)	No charge	No charge
J-SAR	Less Cylinder, Sargent 6300, 6-pin FSIC	No charge	No charge
J-CO6	Less Cylinder, Corbin 8000, 6-pin FSIC	No charge	No charge
J-CO7	Less Cylinder, Corbin 8000-7, 7-pin FSIC, (Only RHO, 8RO, SPA, 8SP, TLR and 8TR)	No charge	No charge
J-MED	Less Cylinder, Medeco 32*0201, 6-pin FSIC (Only RHO, 8RO, SPA, 8SP lever styles)	No charge	No charge
J-YA6	Less Cylinder, Yale 1210 or Medeco 31*0100, 6-pin FSIC	No charge	No charge
J-YA7	Less Cylinder, Yale 1220, 7-pin FSIC (Only RHO, 8RO, SPA, 8SP lever styles)	No charge	No charge
L-FA7	Less Cylinder, Falcon, 7-pin, KIL (Only RHO, 8RO, SPA, 8SP lever styles)	No charge	No charge

- Master Keyed cylinders can be specified and will be shipped in lock packaging. For Master Keying System Summary form which should accompany the master keyed order, see page 296.

△ For master keying, an additional charge of \$28.30 each applies. Specify line item 50-210.

□ Control keys for installation/removal of interchangeable cores are not furnished and must be ordered separate.

For additional assistance on Master Keying as well as restricted keyways, please contact customer service.

AD-302 NETWORKED HARDWIRED

EXIT TRIM (FIPS 201-2 COMPLIANT)

9. Select keying type		Price adjustment
Open keyway families: KIL or FSIC⁴		
S123	Everest 29 S (Key in Lever or FSIC)	Standard
C123	Everest C	No charge
C/CE/E/EF/F/FG/G	Classic Obverse	No charge
Restricted keyway families: KIL or FSIC^{4,5}		
29T	Everest 29 T	\$30.00
D	Everest D	\$30.00
Classic Restricted	Quad, Numbered, Reverse	\$30.00
Restricted keyway families: SFIC⁶		
29 R	Everest 29 R	No charge
B	Everest B	No charge

4. Full Size key systems (Everest 29 S and T, Everest C and D, Obverse and Quad) are available in Primus and Primus XP key system and must be ordered separately. Lock should be ordered less cylinder and Primus cylinder should be a separate line.
5. Everest Restricted Keyways require a Letter of Authorization to be submitted with the order. See page 302 for sample Letter of Authorization.
6. Master Keyed cylinders can be specified and will be shipped in lock packaging. For Master Keying System Summary form which should accompany the master keyed order, see page 296.

10. Select handing (field reversible)		Price adjustment
RHR	Right handed reverse	No charge
LHR	Left handed reverse	No charge

11. Select battery		Price adjustment
Cover only	No batteries or holder	Standard

12. – 13. No selection required

14. Select door thickness		Price adjustment
134	1-3/4"	Standard
Example 200	1-3/4" to 2-3/4", (Specify in 1/8" increments)	\$83.00

15. Select options		Price adjustment
LRX	Less Von Duprin low current Request-To-Exit switch	-\$73.00
BAA ⁷	BAA Compliant product	\$125.00

7. BAA compliant products must have the cover letter on page 306 included with the order. Failure to use this cover letter will result in the customer receiving non-BAA compliant product with no recourse for an RMA or refund. BAA compliant product requires a longer lead time, please contact customer service for details.
8. Connections other than Wiegand or Clock & Data may incur additional fee. Consult access control software provider for details.
9. Add PIB300-2D if Wiegand or Clock & Data connection to ACP is required. Sold separately. See page 136 for details.
10. AD-302 Exit trim comes with a universal mounting plate and is compatible with Von Duprin Series 98/99, 98/99XP, 22/22F exit devices and Falcon 25 rim exit devices. RX-LC switch is included unless lock is ordered as LRX, Less Request-to-Exit switch. Please specify if Von Duprin or Falcon RX-LC switch is required. Concealed Vertical Rod and Concealed Vertical Cable trim on metal door only.
When Request-to-exit is required, the Von Duprin RX-LC switch (part #050281) or Falcon AE switch (part #650359) must be used or the Warranty is void.

Standard accessories sold separately available, see pages 133–138.

AD-400 NETWORKED WIRELESS **CYLINDRICAL**

1-4. Select chassis/function (Note: Locking function capabilities are determined by users access control system.)		Price
AD-400-CY-70 ¹	Storeroom	\$2,785.00
AD-400-CY-50 ^{1,2}	Office/Classroom	\$2,795.00
AD-400-CY-40 ²	Privacy	\$2,795.00
AD-400-CY-60 ²	Apartment	\$2,795.00

1. Less Door Position Switch, use suffix LDP. -\$27.00
2. Requires RS485 connection to ACP. See page 99 for system diagram. Check with access control software provider to verify function is enabled.

5. Select reader (Note: Reflects price adder to base keypad reader price of \$741.00)		Price adjustment
LLL ³	Less Reader	-\$741.00
KP	Keypad	Standard
MS	Magnetic Stripe (Swipe)	\$139.00
MSK	Magnetic Stripe (Swipe) + Keypad	\$229.00
MG	Magnetic Stripe (Insert)	\$160.00
MGK	Magnetic Stripe (Insert) + Keypad	\$255.00
MT	Multi-Technology Proximity and Smart Card	\$275.00
MTK	Multi-Technology + Keypad Proximity and Smart Card	\$364.00
SI	Smart Technology iClass Compatible Reader	\$479.00
SIK	Smart Technology iClass Compatible Reader + Keypad	\$566.00

3. For reader module accessories sold separately, see page 175.
4. FIPS 201-2 Compliant when applied with the FIPS Multi-technology plus keypad reader module (FMK) and by utilizing the most current firmware available. See page 175 for the FMK reader module.

6. Select lever⁵		Price adjustment
LLL	Less each lever	-\$31.00
Standard options	SPA (Sparta), RHO (Rhodes), ATH (Athens), TLR (Tubular), BRW (Broadway), BRK (Boardwalk), LAT (Latitude), LON (Longitude)	No charge

5. Tactile Warning use 8AT for Athens, 8RO for Rhodes, 8SP for Sparta and 8TR for Tubular. \$67.00 per lever. Applied to exterior lever only unless otherwise specified. Not available with 643e finish.

7. Select finish		Price adjustment
626	Satin Chrome	No charge
605	Bright Brass	\$166.00
606	Satin Brass	\$166.00
612	Satin Bronze (00C rose not available in 612 finish)	\$166.00
619	Satin Nickel	\$166.00
625	Bright Chrome	\$166.00
643e	Aged Bronze	\$166.00
626AM	Satin Chrome Antimicrobial	\$215.00

AD-400-CY-70-MG

KP

MGK

MS

MSK

MT/SI

MTK/SIK/FMK

AD-400 NETWORKED WIRELESS

CYLINDRICAL

8. Select cylinder type		Price adjustment	
		Open	Restricted
<input type="checkbox"/> ● P6	With Cylinder, Schlage - (Everest 29 S123, 6-pin KIL standard)	No charge	\$30.00
L	Less Cylinder, Schlage, Falcon, 6-pin KIL	-\$90.00	-\$90.00
<input type="checkbox"/> ● R	With Cylinder, Schlage 6-pin (Everest 29 S123 standard) FSIC	\$102.00	\$132.00
J	Less Cylinder, Schlage, 6-pin FSIC	-\$55.00	-\$55.00
<input type="checkbox"/> ● G	With Cylinder, Schlage 7-pin (Everest 29R standard) (factory master keyed only) SFIC	N/A	\$113.00
B	Less Cylinder, Schlage, Falcon, Competitive OEM's, 7-pin (SFIC)	-\$55.00	-\$55.00
L-SAR	Less Cylinder, Sargent (10L + 11L), 6-pin KIL (Only RHO, 8RO, SPA, 8SP, TLR, 8TR, ATH, 8AT lever styles)	No charge	No charge
L-CO6	Less Cylinder, Corbin, 6-pin KIL (Only RHO, 8RO, SPA, 8SP lever styles)	No charge	No charge
J-SAR	Less Cylinder, Sargent 6300, 6-pin FSIC	No charge	No charge
J-CO6	Less Cylinder, Corbin 8000, 6-pin FSIC	No charge	No charge
J-CO7	Less Cylinder, Corbin 8000-7, 7-pin FSIC, (Only RHO, 8RO, SPA, 8SP, TLR and 8TR)	No charge	No charge
J-MED	Less Cylinder, Medeco 32*0201, 6-pin FSIC (Only RHO, 8RO, SPA, 8SP lever styles)	No charge	No charge
J-YA6	Less Cylinder, Yale 1210 or Medeco 31*0100, 6-pin FSIC	No charge	No charge
J-YA7	Less Cylinder, Yale 1220, 7-pin FSIC (Only RHO, 8RO, SPA, 8SP lever styles)	No charge	No charge
L-FA7	Less Cylinder, Falcon, 7-pin, KIL (Only RHO, 8RO, SPA, 8SP lever styles)	No charge	No charge

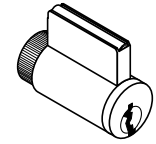
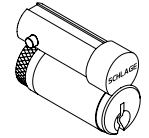
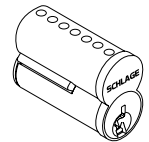
 Full Cylinder
P6, L, L-SAR, L-FA7

 FSIC Format
R, J, J-SAR, J-CO6,
J-CO7, J-YA6

 SFIC Format
B, G

● Master Keyed cylinders can be specified and will be shipped in lock packaging. For Master Keying System Summary form which should accompany the master keyed order, see page 296.

△ For master keying, an additional charge of \$28.30 each applies. Specify line item 50-210.

Control keys for installation/removal of interchangeable cores are not furnished and must be ordered separate.

For additional assistance on Master Keying as well as restricted keyways, please contact customer service.

9. Select keying type		Price adjustment
Open keyway families: KIL or FSIC⁶		
S123	Everest 29 S (Key in Lever or FSIC)	Standard
C123	Everest C	No charge
C/CE/E/EF/F/FG/G	Classic Obverse	No charge
Restricted keyway families: KIL or FSIC^{6,7}		
29T	Everest 29 T	\$30.00
D	Everest D	\$30.00
Classic Restricted	Quad, Numbered, Reverse	\$30.00
Restricted keyway families: SFIC⁸		
29 R	Everest 29 R	No charge
B	Everest B	No charge

6. Full Size key systems (Everest 29 S and T, Everest C and D, Obverse and Quad) are available in Primus and Primus XP key system and must be ordered separately. Lock should be ordered less cylinder and Primus cylinder should be a separate line.

7. Everest Restricted Keyways require a Letter of Authorization to be submitted with the order. See page 302 for sample Letter of Authorization.

8. Master Keyed cylinders can be specified and will be shipped in lock packaging. For Master Keying System Summary form which should accompany the master keyed order, see page 296.

10. Select handing (field reversible)		Price adjustment
RH	Right handed	No charge
LH	Left handed	No charge
RHR	Right handed reverse	No charge
LHR	Left handed reverse	No charge



AD-400 NETWORKED WIRELESS

CYLINDRICAL

11. Select battery **Price adjustment**

LLL	Less Battery Holder, batteries, and cover	-\$36.40
4B	4AA Battery kit	Standard
8B	8AA Battery kit	\$54.90

12. Select backset and latch bolt **Price adjustment**

LLL	Less Latch	-\$48.00
13-247	2-3/4" Backset, deadlatch, square corner, 1-1/8" x 2-1/4"	Standard
14-049	2-3/4" Backset, deadlatch anti-friction fire door latch, square corner, 1-1/8" x 2-1/4", 3/4" throw	\$254.00
14-051	2-3/8" Backset, deadlatch square corner, 1-1/8" x 2-1/4"	No charge
14-050	3-3/4" Backset, deadlatch square corner, 1-1/8" x 2-1/4"	\$15.00
43-001	5" Backset extension link, deadlatch	\$47.00
39-030 ⁹	Rabbeted latch and strike kit, 605 and 626 only	\$85.00

9. Adapts square corner latch and 2-3/4" square corner strike to 1/2" rabbeted door and frame.

13. Select strike plate **Price adjustment**

LLL	Less Strike Plate	-\$6.30
10-025	1-3/16" Lip, ANSI, no box, 1-1/14" x 4-7/8"	Standard
10-013 ¹⁰	1-1/8" Lip, square corner, T-strike, box, 1-1/8" - 2-3/4"	No charge
10-016	1-1/8" Lip, square corner, T-strike, deep box, fire door latch	No charge
K510-066	Box for ANSI strike (Must be specific)	No charge

10. 1-1/2" Lip available, must specify 1-1/2" Lip \$9.90.

14. Select door thickness **Price adjustment**

134	1-3/4"	Standard
Example 138	1-3/8" to 2-3/4", Shims included (Specify in 1/8" increments)	\$83.00

15. Select options **Price adjustment**

BAA ¹¹	BAA Compliant product	\$125.00
-------------------	-----------------------	----------

11. BAA compliant products must have the cover letter on page 306 included with the order. Failure to use this cover letter will result in the customer receiving non-BAA compliant product with no recourse for an RMA or refund. BAA compliant product requires a longer lead time, please contact customer service for details.

12. Connections other than Wiegand or Clock & Data may incur additional fee. Consult access control software provider for details.

13. PIM400 required for connection to ACP; sold separately.

- PIM400-TD2 required for Wiegand or Clock & Data connection, See page 136.
- If RS485 connection to other ACP is required, contact software provider.

Accessories including Panel Interface Module (PIM400) Decorative plates, SUS A-KIT, etc. available, see pages 133-138.

Credentials available, see pages 16-20.

AD-400 NETWORKED WIRELESS
MORTISE/MORTISE DEADBOLT

1-3. Select chassis		Price
AD-400-MS	Mortise	\$3,154.00
AD-400-MD ²	Mortise Deadbolt	\$3,200.00

4. Select function	(Note: Locking function capabilities are determined by users access control system.)	Price adjustment
70 ¹	Storeroom (Not available on Mortise Deadbolt)	Standard
50 ^{1,2}	Office/Classroom (Not available on Mortise Deadbolt)	\$10.00
40 ^{2,3}	Privacy	\$10.00
60 ^{2,3}	Apartment	\$10.00

1. Less Door Position Switch, use suffix LDP. -\$27.00
2. Requires RS485 connection to ACP. See page 99 for system diagram. Check with access control software provider to verify function is enabled.
3. Inside Push Button (IPB) only included with Mortise (MS) chassis. Mortise Deadbolt (MD) chassis comes with LED indicator only. \$10.00 charge does not apply to Mortise Deadbolt (MD) chassis.

5. Select reader	(Note: Reflects price adder to base keypad reader price of \$741.00)	Price adjustment
LLL ⁴	Less Reader	-\$741.00
KP	Keypad	Standard
MS	Magnetic Stripe (Swipe)	\$139.00
MSK	Magnetic Stripe (Swipe) + Keypad	\$229.00
MG	Magnetic Stripe (Insert)	\$160.00
MGK	Magnetic Stripe (Insert) + Keypad	\$255.00
MT	Multi-Technology Proximity and Smart Card	\$275.00
MTK	Multi-Technology + Keypad Proximity and Smart Card	\$364.00
SI	Smart Technology iClass Compatible Reader	\$479.00
SIK	Smart Technology iClass Compatible Reader + Keypad	\$566.00

4. For reader module accessories sold separately, see page 175.
5. FIPS 201-2 Compliant when applied with the FIPS Multi-technology plus keypad reader module (FMK) and by utilizing the most current firmware available. See page 175 for the FMK reader module.

6. Select lever ⁶		Price adjustment
LLL	Less interior and exterior levers	-\$89.60
Standard options	SPA (Sparta), RHO (Rhodes), ATH (Athens), TLR (Tubular), BRW (Broadway), BRK (Boardwalk), LAT (Latitude), LON (Longitude)	No charge

6. Tactile Warning use 8AT for Athens, 8RO for Rhodes, 8SP for Sparta and 8TR for Tubular. \$67.00 per lever. Applied to exterior lever only unless otherwise specified. Not available with 643e finish.

7. Select finish		Price adjustment
626	Satin Chrome	No charge
605	Bright Brass	\$166.00
606	Satin Brass	\$166.00
612	Satin Bronze	\$166.00
619	Satin Nickel	\$166.00
625	Bright Chrome	\$166.00
643e	Aged Bronze	\$166.00
626AM	Satin Chrome Antimicrobial	\$215.00



AD-400 NETWORKED WIRELESS
MORTISE/MORTISE DEADBOLT

NETWORKED LOCKS

STANDALONE LOCKS

PARTS

8. Select cylinder type		Price adjustment	
		Open	Restricted
<input type="checkbox"/> ● P6	With Cylinder, Schlage - (Everest 29 S123, 6-pin KIL standard)	No charge	\$30.00
L	Less Cylinder, Schlage, Falcon, 6-pin KIL	-\$90.00	-\$90.00
<input type="checkbox"/> ● R	With Cylinder, Schlage 6-pin (Everest 29 S123 standard) FSIC	\$102.00	\$132.00
J	Less Cylinder, Schlage, 6-pin FSIC	-\$55.00	-\$55.00
<input type="checkbox"/> ● G	With Cylinder, Schlage 7-pin (Everest 29R standard) (factory master keyed only) SFIC	N/A	\$113.00
B	Less Cylinder, Schlage, Falcon, Competitive OEM's, 7-pin (SFIC)	-\$55.00	-\$55.00
L-SAR	Less Cylinder, Sargent (10L + 11L), 6-pin KIL (Only RHO, 8RO, SPA, 8SP, TLR, 8TR, ATH, 8AT lever styles)	No charge	No charge
L-CO6	Less Cylinder, Corbin, 6-pin KIL (Only RHO, 8RO, SPA, 8SP lever styles)	No charge	No charge
J-SAR	Less Cylinder, Sargent 6300, 6-pin FSIC	No charge	No charge
J-CO6	Less Cylinder, Corbin 8000, 6-pin FSIC	No charge	No charge
J-CO7	Less Cylinder, Corbin 8000-7, 7-pin FSIC, (Only RHO, 8RO, SPA, 8SP, TLR and 8TR)	No charge	No charge
J-MED	Less Cylinder, Medeco 32*0201, 6-pin FSIC (Only RHO, 8RO, SPA, 8SP lever styles)	No charge	No charge
J-YA6	Less Cylinder, Yale 1210 or Medeco 31*0100, 6-pin FSIC	No charge	No charge
J-YA7	Less Cylinder, Yale 1220, 7-pin FSIC (Only RHO, 8RO, SPA, 8SP lever styles)	No charge	No charge
L-FA7	Less Cylinder, Falcon, 7-pin, KIL (Only RHO, 8RO, SPA, 8SP lever styles)	No charge	No charge

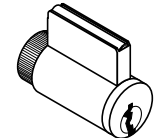
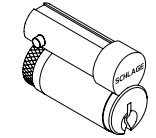
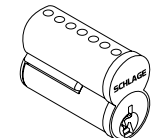
Full Cylinder
P6, L, L-SAR, L-FA7

FSIC Format
R, J, J-SAR, J-CO6, J-CO7, J-YA6

SFIC Format
B, G

- Master Keyed cylinders can be specified and will be shipped in lock packaging. For Master Keying System Summary form which should accompany the master keyed order, see page 296.
- △ For master keying, an additional charge of \$28.30 each applies. Specify line item 50-210.
- Control keys for installation/removal of interchangeable cores are not furnished and must be ordered separate. For additional assistance on Master Keying as well as restricted keyways, please contact customer service.

9. Select keying type		Price adjustment
Open keyway families: KIL or FSIC⁷		
S123	Everest 29 S (Key in Lever or FSIC)	Standard
C123	Everest C	No charge
C/CE/E/EF/F/FG/G	Classic Obverse	No charge
Restricted keyway families: KIL or FSIC^{7,8}		
29T	Everest 29 T	\$30.00
D	Everest D	\$30.00
Classic Restricted	Quad, Numbered, Reverse	\$30.00
Restricted keyway families: SFIC⁹		
29R	Everest 29 R	No charge
B	Everest B	No charge

7. Full size key systems (Everest 29 S and T, Everest C and D, Obverse and Quad) are available in Primus and Primus XP key system and must be ordered separately. Lock should be ordered less cylinder and Primus cylinder should be a separate line.
8. Everest restricted keyways require a Letter of Authorization to be submitted with the order. See page 302 for sample Letter of Authorization.
9. Master keyed cylinders can be specified and will be shipped in lock packaging. For Master Keying System Summary form which should accompany the master keyed order, see page 296.

10. Select handing (field reversible)		Price adjustment
RH	Right handed	Standard
LH	Left handed	No charge
RHR	Right handed reverse	No charge
LHR	Left handed reverse	No charge



AD-400 NETWORKED WIRELESS

MORTISE/MORTISE DEADBOLT

11. Select battery		Price adjustment
LLL	Less Battery Holder, batteries, and cover	-\$36.40
4B	4AA Battery kit	Standard
8B	8AA Battery kit	\$54.90

12. Select mortise lock armor front		Price adjustment
LLL	Less Armor Front	-\$23.60
09-663	1-1/4" Wide square corner, latch for MS	Standard
09-669	1-1/16" Wide square corner, latch, options for MS	No charge
09-666	1-1/4" Wide square corner, latch x deadbolt for MD	Standard
09-672	1-1/16" Wide square corner, latch x deadbolt, options for MD	No charge

13. Select strike plate		Price adjustment
LLL	Less Strike	-\$18.40
10-072	1-1/4" x 4-7/8" Square corner + box; 1-3/16" lip length	Standard
10-072xx	1-1/4" x 4-7/8" Square corner + box; specify lip length (xx) as 1" or 1-1/2"	No charge
10-072xx	1-1/4" x 4-7/8" Square corner + box; specify lip length (xx) as 1-3/4"	\$45.00
10-075 ¹⁰	1/2" Rabbeted	\$155.00
37-015	Strike frame reinforcer, specify 37-015	No charge

10. For 1-3/4" thick doors, use wide armor front. For over 1-3/4" thick door extended equally (EE) use 1-1/4" wide armor front.

⊗ Extended lead time, consult customer service.

14. Select door thickness		Price adjustment
134	1-3/4"	Standard
Example 138	1-3/8" to 2-3/4", Shims included (Specify in 1/8" increments)	\$83.00

15. Select options		Price adjustment
BAA ¹¹	BAA Compliant product	\$125.00

11. BAA compliant products must have the cover letter on page 306 included with the order. Failure to use this cover letter will result in the customer receiving non-BAA compliant product with no recourse for an RMA or refund. BAA compliant product requires a longer lead time, please contact customer service for details.

12. Connections other than Wiegand or Clock & Data may incur additional fee. Consult access control software provider for details.

13. PIM400 required for connection to ACP; sold separately.

- PIM400-TD2 required for Wiegand or Clock & Data connection, See page 136.
- If RS485 connection to other ACP is required, contact software provider.

Accessories including Panel Interface Module (PIM400) Decorative plates, SUS A-KIT, etc. available, see pages 133-138.

Credentials available, see pages 16-20.

AD-400 NETWORKED WIRELESS EXIT TRIM



AD-400-993R-70-MTK



KP



MG



MGK



MS



MSK



MT/SI



MTK/SIK/FMK

1-3. Select chassis/trim type (Note: See page 88 for exit device compatibility.) **Price**

AD-400-993R	Exit Rim / Concealed Vertical Rod (Metal Door) / Concealed Vertical Cable (Metal Door)	\$3,248.00
AD-400-993S	Exit Surface Vertical Rod	\$3,284.00
AD-400-993M	Exit Mortise Lock	\$3,284.00

4. Select function (Note: Locking function capabilities are determined by users access control system.) **Price adjustment**

70 ¹	Storeroom (Not available on Mortise Deadbolt)	Standard
50 ^{1,2}	Office/Classroom (Not available on Mortise Deadbolt)	\$10.00
40 ²	Privacy	\$10.00
60 ²	Apartment	\$10.00

1. Less Door Position Switch, use suffix LDP. -\$27.00
2. Requires RS485 connection to ACP. See page 99 for system diagram. Check with access control software provider to verify function is enabled.

5. Select reader (Note: Reflects price adder to base keypad reader price of \$741.00) **Price adjustment**

LLL ³	Less Reader	-\$741.00
KP	Keypad	Standard
MS	Magnetic Stripe (Swipe)	\$139.00
MSK	Magnetic Stripe (Swipe) + Keypad	\$229.00
MG	Magnetic Stripe (Insert)	\$160.00
MGK	Magnetic Stripe (Insert) + Keypad	\$255.00
MT	Multi-Technology Proximity and Smart Card	\$275.00
MTK	Multi-Technology + Keypad Proximity and Smart Card	\$364.00
SI	Smart Technology iClass Compatible Reader	\$479.00
SIK	Smart Technology iClass Compatible Reader + Keypad	\$566.00

3. For reader module accessories sold separately, see page 175.

6. Select lever⁴ **Price adjustment**

LLL	Less interior and exterior levers	-\$31.00
Standard options	SPA (Sparta), RHO (Rhodes), ATH (Athens), TLR (Tubular), BRW (Broadway), BRK (Boardwalk), LAT (Latitude), LON (Longitude)	No charge

4. Tactile Warning use 8AT for Athens, 8RO for Rhodes, 8SP for Sparta and 8TR for Tubular. \$67.00 per lever. Applied to exterior lever only unless otherwise specified. Not available with 643e finish.

7. Select finish **Price adjustment**

626	Satin Chrome	No charge
605	Bright Brass	\$166.00
606	Satin Brass	\$166.00
612	Satin Bronze	\$166.00
619	Satin Nickel	\$166.00
625	Bright Chrome	\$166.00
643e	Aged Bronze	\$166.00
626AM	Satin Chrome Antimicrobial	\$215.00

NETWORKED LOCKS

STANDALONE LOCKS

PARTS

AD-400 NETWORKED WIRELESS

EXIT TRIM

		Price adjustment	
		Open	Restricted
8. Select cylinder type			
<input type="checkbox"/> ● P6	With Cylinder, Schlage - (Everest 29 S123, 6-pin KIL standard)	No charge	\$30.00
L	Less Cylinder, Schlage, Falcon, 6-pin KIL	-\$90.00	-\$90.00
<input type="checkbox"/> ● R	With Cylinder, Schlage 6-pin (Everest 29 S123 standard) FSIC	\$102.00	\$132.00
J	Less Cylinder, Schlage, 6-pin FSIC	-\$55.00	-\$55.00
<input type="checkbox"/> ● G	With Cylinder, Schlage 7-pin (Everest 29R standard) (factory master keyed only) SFIC	N/A	\$113.00
B	Less Cylinder, Schlage, Falcon, Competitive OEM's, 7-pin (SFIC)	-\$55.00	-\$55.00
L-SAR	Less Cylinder, Sargent (10L + 11L), 6-pin KIL (Only RHO, 8RO, SPA, 8SP, TLR, 8TR, ATH, 8AT lever styles)	No charge	No charge
L-CO6	Less Cylinder, Corbin, 6-pin KIL (Only RHO, 8RO, SPA, 8SP lever styles)	No charge	No charge
J-SAR	Less Cylinder, Sargent 6300, 6-pin FSIC	No charge	No charge
J-CO6	Less Cylinder, Corbin 8000, 6-pin FSIC	No charge	No charge
J-CO7	Less Cylinder, Corbin 8000-7, 7-pin FSIC, (Only RHO, 8RO, SPA, 8SP, TLR and 8TR)	No charge	No charge
J-MED	Less Cylinder, Medeco 32*0201, 6-pin FSIC (Only RHO, 8RO, SPA, 8SP lever styles)	No charge	No charge
J-YA6	Less Cylinder, Yale 1210 or Medeco 31*0100, 6-pin FSIC	No charge	No charge
J-YA7	Less Cylinder, Yale 1220, 7-pin FSIC (Only RHO, 8RO, SPA, 8SP lever styles)	No charge	No charge
L-FA7	Less Cylinder, Falcon, 7-pin, KIL (Only RHO, 8RO, SPA, 8SP lever styles)	No charge	No charge

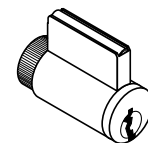
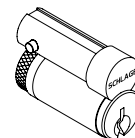
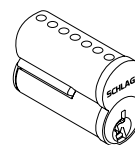
 Full Cylinder
P6, L, L-SAR, L-FA7

 FSIC Format
R, J, J-SAR, J-CO6,
J-CO7, J-YA6

 SFIC Format
B, G

● Master Keyed cylinders can be specified and will be shipped in lock packaging. For Master Keying System Summary form which should accompany the master keyed order, see page 296.

△ For master keying, an additional charge of \$28.30 each applies. Specify line item 50-210.

Control keys for installation/removal of interchangeable cores are not furnished and must be ordered separate.

For additional assistance on Master Keying as well as restricted keyways, please contact customer service.

9. Select keying type		Price adjustment
Open keyway families: KIL or FSIC⁵		
S123	Everest 29 S (Key in Lever or FSIC)	Standard
C123	Everest C	No charge
C/CE/E/EF/F/FG/G	Classic Obverse	No charge
Restricted keyway families: KIL or FSIC^{5,6}		
29T	Everest 29 T	\$30.00
D	Everest D	\$30.00
Classic Restricted	Quad, Numbered, Reverse	\$30.00
Restricted keyway families: SFIC⁷		
29 R	Everest 29 R	No charge
B	Everest B	No charge

5. Full Size key systems (Everest 29 S and T, Everest C and D, Obverse and Quad) are available in Primus and Primus XP key system and must be ordered separately. Lock should be ordered less cylinder and Primus cylinder should be a separate line.

6. Everest restricted keyways require a Letter of Authorization to be submitted with the order. See page 302 for sample Letter of Authorization.

7. Master Keyed cylinders can be specified and will be shipped in lock packaging. For Master Keying System Summary form which should accompany the master keyed order, see page 296.

10. Select handing (field reversible)		Price adjustment
RHR	Right handed reverse	No charge
LHR	Left handed reverse	No charge



AD-400 NETWORKED WIRELESS EXIT TRIM

11. Select battery		Price adjustment
LLL	Less Battery Holder, batteries, and cover	-\$36.40
4B	4AA Battery kit	Standard
8B	8AA Battery kit	\$54.90

12. – 13. No selection required

14. Select door thickness		Price adjustment
134	1-3/4"	Standard
Example 200	1-3/4" to 2-3/4", (Specify in 1/8" increments)	\$83.00

15. Select options		Price adjustment
LRX	Less Von Duprin low current Request-To-Exit switch	-\$73.00
BAA ⁸	BAA Compliant product	\$125.00

- 8. BAA compliant products must have the cover letter on page 306 included with the order. Failure to use this cover letter will result in the customer receiving non-BAA compliant product with no recourse for an RMA or refund. BAA compliant product requires a longer lead time, please contact customer service for details.
- 9. Connections other than Wiegand or Clock & Data may incur additional fee. Consult access control software provider for details.
- 10. PIM400 required for connection to ACP; sold separately.
 - PIM400-TD2 required for Wiegand or Clock & Data connection, see page 136.
 - If RS485 connection to other ACP is required, contact software provider.
- 11. AD-300 Exit trim comes with a universal mounting plate and is compatible with Von Duprin Series 98/99, 98/99XP, 22/22F exit devices and Falcon 25 rim exit devices. RX-LC switch is included unless lock is ordered as LRX, Less Request-to-Exit switch. Please specify if Von Duprin or Falcon RX-LC switch is required. Concealed Vertical Rod and Concealed Vertical Cable trim on metal door only. **When Request-to-exit is required, the Von Duprin RX-LC switch (part #050281) or Falcon AE switch (part #650359) must be used or the Warranty is void.**

Accessories available, see pages 133–138.

Credentials available, see pages 16–20.

AD Series Non-Functioning "Dummy" Exit trim now available. Please see pages 131–132 for details.

NETWORKED LOCKS

STANDALONE LOCKS

PARTS

AD-402 NETWORKED WIRELESS
CYLINDRICAL (FIPS 201-2 COMPLIANT)

1-4. Select chassis/function (Note: Locking function capabilities are determined by users access control system.)		Price
AD-402-CY-70 ¹	Storeroom	\$2,785.00
AD-402-CY-50 ¹	Office/Classroom	\$2,795.00
AD-402-CY-40 ²	Privacy	\$2,795.00
AD-402-CY-60 ²	Apartment	\$2,795.00

1. Less Door Position Switch, use suffix LDP. -\$27.00
2. Requires RS485 connection to ACP. See page 100 for system diagram. Check with Access Control software provider to verify function is enabled.

5. Select reader		Price adjustment
FMK	FIPS 201-2 Multi-Technology + Keypad Proximity and Smart Card (PIV and PIV-I Card)	\$664.00

The AD-400 lock can be field upgraded to a FIPS 201-2 compliant solution simply by adding the FMK reader (sold separately) and by using the most current firmware revision.

Verify compatibility of PIV and PIV-I credentials with access control software provider.

6. Select lever ³		Price adjustment
LLL	Less each lever	-\$31.00
Standard options	SPA (Sparta), RHO (Rhodes), ATH (Athens), TLR (Tubular), BRW (Broadway), BRK (Boardwalk), LAT (Latitude), LON (Longitude)	No charge

3. Tactile Warning use 8AT for Athens, 8RO for Rhodes, 8SP for Sparta and 8TR for Tubular. \$67.00 per lever. Applied to exterior lever only unless otherwise specified. Not available with 643e finish.

7. Select finish		Price adjustment
626	Satin Chrome	No charge
605	Bright Brass	\$166.00
606	Satin Brass	\$166.00
612	Satin Bronze	\$166.00
619	Satin Nickel	\$166.00
625	Bright Chrome	\$166.00
643e	Aged Bronze	\$166.00
626AM	Satin Chrome Antimicrobial	\$215.00

8. Select cylinder type		Price adjustment	
		Open	Restricted
<input type="checkbox"/> ● P6	With Cylinder, Schlage - (Everest 29 S123, 6-pin KIL standard)	No charge	\$30.00
L	Less Cylinder, Schlage, Falcon, 6-pin KIL	-\$90.00	-\$90.00
<input type="checkbox"/> ● R	With Cylinder, Schlage 6-pin (Everest 29 S123 standard) FSIC	\$102.00	\$132.00
J	Less Cylinder, Schlage, 6-pin FSIC	-\$55.00	-\$55.00
<input type="checkbox"/> ● G	With Cylinder, Schlage 7-pin (Everest 29R standard) (factory master keyed only) SFIC	N/A	\$113.00
B	Less Cylinder, Schlage, Falcon, Competitive OEM's, 7-pin (SFIC)	-\$55.00	-\$55.00
L-SAR	Less Cylinder, Sargent (10L + 11L), 6-pin KIL (Only RHO, 8RO, SPA, 8SP, TLR, 8TR, ATH, 8AT lever styles)	No charge	No charge
L-CO6	Less Cylinder, Corbin, 6-pin KIL (Only RHO, 8RO, SPA, 8SP lever styles)	No charge	No charge
J-SAR	Less Cylinder, Sargent 6300, 6-pin FSIC	No charge	No charge
J-CO6	Less Cylinder, Corbin 8000, 6-pin FSIC	No charge	No charge
J-CO7	Less Cylinder, Corbin 8000-7, 7-pin FSIC, (Only RHO, 8RO, SPA, 8SP, TLR and 8TR)	No charge	No charge
J-MED	Less Cylinder, Medeco 32*0201, 6-pin FSIC (Only RHO, 8RO, SPA, 8SP lever styles)	No charge	No charge
J-YA6	Less Cylinder, Yale 1210 or Medeco 31*0100, 6-pin FSIC	No charge	No charge
J-YA7	Less Cylinder, Yale 1220, 7-pin FSIC (Only RHO, 8RO, SPA, 8SP lever styles)	No charge	No charge
L-FA7	Less Cylinder, Falcon, 7-pin, KIL (Only RHO, 8RO, SPA, 8SP lever styles)	No charge	No charge

● Master Keyed cylinders can be specified and will be shipped in lock packaging. For Master Keying System Summary form which should accompany the master keyed order, see page 296.

△ For master keying, an additional charge of \$28.30 each applies. Specify line item 50-210.

Control keys for installation/removal of interchangeable cores are not furnished and must be ordered separate.

For additional assistance on Master Keying as well as restricted keyways, please contact customer service.

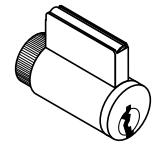
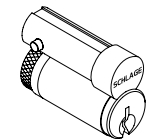
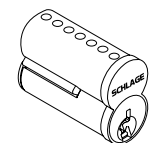

AD-402-CY-70-FMK

 Full Cylinder
P6, L, L-SAR, L-FA7

 FSIC Format
R, J, J-SAR, J-CO6,
J-CO7, J-YA6

 SFIC Format
B, G

AD-402 NETWORKED WIRELESS CYLINDRICAL (FIPS 201-2 COMPLIANT)

9. Select keying type **Price adjustment**

Open keyway families: KIL or FSIC⁴		
S123	Everest 29 S (Key in Lever or FSIC)	Standard
C123	Everest C	No charge
C/CE/E/EF/F/FG/G	Classic Obverse	No charge
Restricted keyway families: KIL or FSIC^{4,5}		
29T	Everest 29 T	\$30.00
D	Everest D	\$30.00
Classic Restricted	Quad, Numbered, Reverse	\$30.00
Restricted keyway families: SFIC⁶		
29R	Everest 29 R	No charge
B	Everest B	No charge

- Full size key systems (Everest 29 S and T, Everest C and D, Obverse and Quad) are available in Primus and Primus XP key system and must be ordered separately. Lock should be ordered less cylinder and Primus cylinder should be a separate line.
- Everest restricted keyways require a Letter of Authorization to be submitted with the order. See page 302 for sample Letter of Authorization.
- Master keyed cylinders can be specified and will be shipped in lock packaging. For Master Keying System Summary form which should accompany the master keyed order, see page 296.

10. Select handing (field reversible) **Price adjustment**

RH	Right handed	No charge
LH	Left handed	No charge
RHR	Right handed reverse	No charge
LHR	Left handed reverse	No charge

11. Select battery **Price adjustment**

LLL	Less Battery Holder, batteries, and cover	-\$36.40
4B	4AA Battery kit	Standard
8B	8AA Battery kit	\$54.90

12. Select backset and latch bolt **Price adjustment**

LLL	Less Latch	-\$48.00
13-247	2-3/4" Backset, deadlatch, square corner, 1-1/8" x 2-1/4"	Standard
14-049	2-3/4" Backset, deadlatch anti-friction fire door latch, square corner, 1-1/8" x 2-1/4", 3/4" throw	\$254.00
14-051	2-3/8" Backset, deadlatch, square corner, 1-1/8" x 2-1/4"	No charge
14-050	3-3/4" Backset, deadlatch, square corner, 1-1/8" x 2-1/4"	\$15.00
43-001	5" Backset extension link, deadlatch	\$47.00
39-030 ⁷	Rabbeted latch and strike kit, 605 and 626 only	\$85.00

- Adapts square corner latch and 2-3/4" square corner strike to 1/2" rabbeted door and frame.

13. Select strike plate **Price adjustment**

LLL	Less Strike Plate	-\$6.30
10-025	1-3/16" Lip, ANSI, no box, 1-1/14" x 4-7/8"	Standard
10-013 ⁸	1-1/8" Lip, square corner, T-strike, box, 1-1/8" - 2-3/4"	No charge
10-016	1-1/8" Lip, square corner, T-strike, deep box, fire door latch	No charge
K510-066	Box for ANSI strike (Must be specific)	No charge

- 1-1/2" Lip available, must specify 1-1/2" Lip \$9.90.

14. Select door thickness **Price adjustment**

134	1-3/4"	Standard
Example 138	1-3/8" to 2-3/4", Shims included (Specify in 1/8" increments)	\$83.00

15. Select options **Price adjustment**

BAA ⁹	BAA Compliant product	\$125.00
------------------	-----------------------	----------

- BAA compliant products must have the cover letter on page 306 included with the order. Failure to use this cover letter will result in the customer receiving non-BAA compliant product with no recourse for an RMA or refund. BAA compliant product requires a longer lead time, please contact customer service for details.
- Connections other than Wiegand or Clock & Data may incur additional fee. Consult access control software provider for details.
- PIM400 required for connection to ACP; sold separately.
 - PIM400-TD2 required for Wiegand or Clock & Data connection, See page 136.
 - If RS485 connection to other ACP is required, contact software provider.

Standard accessories available, see pages 133-138.

AD-402 NETWORKED WIRELESS
MORTISE/MORTISE DEADBOLT (FIPS 201-2 COMPLIANT)

1-3. Select chassis		Price
AD-402-MS	Mortise	\$3,154.00
AD-402-MD ²	Mortise Deadbolt	\$3,200.00

4. Select function	(Note: Locking function capabilities are determined by users access control system)	Price adjustment
70 ¹	Storeroom (Not available on Mortise Deadbolt)	Standard
50 ^{1,2}	Office/Classroom (Not available on Mortise Deadbolt)	\$10.00
40 ^{2,3}	Privacy	\$10.00
60 ^{2,3}	Apartment	\$10.00

1. Less Door Position Switch, use suffix LDP. -\$27.00
2. Requires RS485 connection to ACP. See page 100 for system diagram. Check with access control software provider to verify function is enabled.
3. Inside Push Button (IPB) only included with Mortise (MS) chassis. Mortise Deadbolt (MD) chassis comes with LED indicator only. \$10.00 charge does not apply to Mortise Deadbolt (MD) chassis.

5. Select reader		Price adjustment
FMK	FIPS 201-2 Multi-Technology + Keypad Proximity and Smart Card (PIV and PIV-I Card)	\$664.00

The AD-300 lock can be field upgraded to a FIPS 201-2 compliant solution simply by adding the FMK reader (sold separately) and by using the most current firmware revision.

Verify compatibility of PIV and PIV-I credentials with access control software provider.

6. Select lever ⁴		Price adjustment
LLL	Less interior and exterior levers	-\$89.60
Standard options	SPA (Sparta), RHO (Rhodes), ATH (Athens), TLR (Tubular), BRW (Broadway), BRK (Boardwalk), LAT (Latitude), LON (Longitude)	No charge

4. Tactile Warning use 8AT for Athens, 8RO for Rhodes, 8SP for Sparta and 8TR for Tubular. \$67.00 per lever. Applied to exterior lever only unless otherwise specified. Not available with 643e finish.

7. Select finish		Price adjustment
626	Satin Chrome	No charge
605	Bright Brass	\$166.00
606	Satin Brass	\$166.00
612	Satin Bronze	\$166.00
619	Satin Nickel	\$166.00
625	Bright Chrome	\$166.00
643e	Aged Bronze	\$166.00
626AM	Satin Chrome Antimicrobial	\$215.00

8. Select cylinder type		Price adjustment	
		Open	Restricted
<input type="checkbox"/> ● P6	With Cylinder, Schlage - (Everest 29 S123, 6-pin KIL standard)	No charge	\$30.00
	L Less Cylinder, Schlage, Falcon, 6-pin KIL	-\$90.00	-\$90.00
<input type="checkbox"/> ● R	With Cylinder, Schlage 6-pin (Everest 29 S123 standard) FSIC	\$102.00	\$132.00
	J Less Cylinder, Schlage, 6-pin FSIC	-\$55.00	-\$55.00
<input type="checkbox"/> ● G	With Cylinder, Schlage 7-pin (Everest 29R standard) (factory master keyed only) SFIC	N/A	\$113.00
	B Less Cylinder, Schlage, Falcon, Competitive OEM's, 7-pin (SFIC)	-\$55.00	-\$55.00
	L-SAR Less Cylinder, Sargent (10L + 11L), 6-pin KIL (Only RHO, 8RO, SPA, 8SP, TLR, 8TR, ATH, 8AT lever styles)	No charge	No charge
	L-CO6 Less Cylinder, Corbin, 6-pin KIL (Only RHO, 8RO, SPA, 8SP lever styles)	No charge	No charge
	J-SAR Less Cylinder, Sargent 6300, 6-pin FSIC	No charge	No charge
	J-CO6 Less Cylinder, Corbin 8000, 6-pin FSIC	No charge	No charge
	J-CO7 Less Cylinder, Corbin 8000-7, 7-pin FSIC, (Only RHO, 8RO, SPA, 8SP, TLR and 8TR)	No charge	No charge
	J-MED Less Cylinder, Medeco 32*0201, 6-pin FSIC (Only RHO, 8RO, SPA, 8SP lever styles)	No charge	No charge
	J-YA6 Less Cylinder, Yale 1210 or Medeco 31*0100, 6-pin FSIC	No charge	No charge
	J-YA7 Less Cylinder, Yale 1220, 7-pin FSIC (Only RHO, 8RO, SPA, 8SP lever styles)	No charge	No charge
	L-FA7 Less Cylinder, Falcon, 7-pin, KIL (Only RHO, 8RO, SPA, 8SP lever styles)	No charge	No charge

● Master Keyed cylinders can be specified and will be shipped in lock packaging. For Master Keying System Summary form which should accompany the master keyed order, see page 296.

△ For master keying, an additional charge of \$28.30 each applies. Specify line item 50-210.

Control keys for installation/removal of interchangeable cores are not furnished and must be ordered separate.

For additional assistance on Master Keying as well as restricted keyways, please contact customer service.

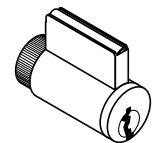
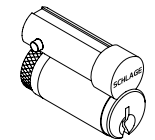
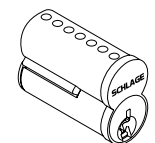
AD-402-MS-70-FMK

**Full Cylinder
P6, L, L-SAR, L-FA7**

**FSIC Format
R, J, J-SAR, J-CO6,
J-CO7, J-YA6**

**SFIC Format
B, G**



AD-402 NETWORKED WIRELESS

MORTISE/MORTISE DEADBOLT (FIPS 201-2 COMPLIANT)

9. Select keying type **Price adjustment**

Open keyway families: KIL or FSIC⁵		
S123	Everest 29 S (Key in Lever or FSIC)	Standard
C123	Everest C	No charge
C/CE/E/EF/F/FG/G	Classic Obverse	No charge
Restricted keyway families: KIL or FSIC^{5,6}		
29T	Everest 29 T	\$30.00
D	Everest D	\$30.00
Classic Restricted	Quad, Numbered, Reverse	\$30.00
Restricted keyway families: SFIC⁷		
29R	Everest 29 R	No charge
B	Everest B	No charge

5. Full size key systems (Everest 29 S and T, Everest C and D, Obverse and Quad) are available in Primus and Primus XP key system and must be ordered separately. Lock should be ordered less cylinder and Primus cylinder should be a separate line.
6. Everest restricted keyways require a Letter of Authorization to be submitted with the order. See page 302 for sample Letter of Authorization.
7. Master keyed cylinders can be specified and will be shipped in lock packaging. For Master Keying System Summary form which should accompany the master keyed order, see page 296.

10. Select handing (field reversible) **Price adjustment**

RH	Right handed	No charge
LH	Left handed	No charge
RHR	Right handed reverse	No charge
LHR	Left handed reverse	No charge

11. Select battery **Price adjustment**

LLL	Less Battery Holder, batteries, and cover	-\$36.40
4B	4AA Battery kit	Standard
8B	8AA Battery kit	\$54.90

12. Select mortise lock armor front **Price adjustment**

LLL	Less Armor Front	-\$23.60
09-663	1-1/4" Wide square corner, latch for MS	Standard
09-669	1-1/16" Wide square corner, Latch, options for MS	No charge
09-666	1-1/4" Wide square corner, latch x deadbolt for MD	Standard
09-672	1-1/16" Wide square corner, latch x deadbolt, options for MD	No charge

13. Select strike plate **Price adjustment**

LLL	Less Strike	-\$18.40
10-072	1-1/4" x 4-7/8" Square corner + box; 1-3/16" lip length	Standard
10-072xx	1-1/4" x 4-7/8" Square corner + box; specify lip length (xx) as 1" or 1-1/2"	No charge
10-072xx	1-1/4" x 4-7/8" Square corner + box; specify lip length (xx) as 1-3/4"	\$45.00
10-075 ⁸	1/2" Rabbeted	\$155.00
37-015	Strike frame reinforcer, specify 37-015	No charge

8. For 1-3/4" thick doors, use wide armor front. For over 1-3/4" thick door extended equally (EE) use 1-1/4" wide armor front.
 8 Extended lead time, consult customer service.

14. Select door thickness **Price adjustment**

134	1-3/4"	Standard
Example 138	1-3/8" to 2-3/4", Shims included (Specify in 1/8" increments)	\$83.00

15. Select options **Price adjustment**

BAA ⁹	BAA Compliant product	\$125.00
------------------	-----------------------	----------

9. BAA compliant products must have the cover letter on page 306 included with the order. Failure to use this cover letter will result in the customer receiving non-BAA compliant product with no recourse for an RMA or refund. BAA compliant product requires a longer lead time, please contact customer service for details.
10. Connections other than Wiegand or Clock & Data may incur additional fee. Consult access control software provider for details.
11. PIM400 required for connection to ACP; sold separately.
- PIM400-TD2 required for Wiegand or Clock & Data connection, see page 136.
 - If RS485 connection to other ACP is required, contact software provider.

Accessories available, see pages 133–138.

Credentials available, see pages 16–20.

AD-402 NETWORKED WIRELESS
EXIT TRIM (FIPS 201-2 COMPLIANT)

1-3. Select chassis/exit trim type (Note: See page 88 for exit device compatibility.)		Price
AD-402-993R	Exit Rim / Concealed Vertical Rod (Metal Door) / Concealed Vertical Cable (Metal Door)	\$3,248.00
AD-402-993S	Exit Surface Vertical Rod	\$3,284.00
AD-402-993M	Exit Mortise Lock	\$3,284.00



AD-402-993R-70-FMK

4. Select function (Note: Locking function capabilities are determined by users access control system.)		Price adjustment
70 ¹	Storeroom	Standard
50 ^{1,2}	Office/Classroom	\$10.00
40 ²	Privacy	\$10.00
60 ²	Apartment	\$10.00

1. Less Door Position Switch, use suffix LDP. -\$27.00
2. Requires RS485 connection to ACP. See page 100 for system diagram. Check with access control software provider to verify function is enabled.

5. Select reader		Price adjustment
FMK	FIPS 201-2 Multi-Technology + Keypad Proximity and Smart Card (PIV and PIV-I Card)	\$664.00

The AD-300 lock can be field upgraded to a FIPS 201-2 compliant solution simply by adding the FMK reader (sold separately) and by using the most current firmware revision.

Verify compatibility of PIV and PIV-I credentials with access control software provider.

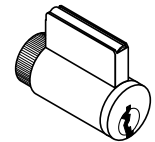
 Full Cylinder
P6, L, L-SAR, L-FA7

6. Select lever ³		Price adjustment
LLL	Less interior and exterior levers	-\$31.00
Standard options	SPA (Sparta), RHO (Rhodes), ATH (Athens), TLR (Tubular), BRW (Broadway), BRK (Boardwalk), LAT (Latitude), LON (Longitude)	No charge

3. Tactile Warning use 8AT for Athens, 8RO for Rhodes, 8SP for Sparta and 8TR for Tubular. \$67.00 per lever. Applied to exterior lever only unless otherwise specified. Not available with 643e finish.

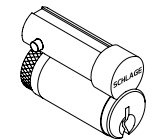
 FSIC Format
R, J, J-SAR, J-CO6,
J-CO7, J-YA6

7. Select finish		Price adjustment
626	Satin Chrome	No charge
605	Bright Brass	\$166.00
606	Satin Brass	\$166.00
612	Satin Bronze	\$166.00
619	Satin Nickel	\$166.00
625	Bright Chrome	\$166.00
643e	Aged Bronze	\$166.00
626AM	Satin Chrome Antimicrobial	\$215.00

8. Select cylinder type		Price adjustment	
		Open	Restricted
△ ● P6	With Cylinder, Schlage - (Everest 29 S123, 6-pin KIL standard)	No charge	\$30.00
L	Less Cylinder, Schlage, Falcon, 6-pin KIL	-\$90.00	-\$90.00
□ ● R	With Cylinder, Schlage 6-pin (Everest 29 S123 standard) FSIC	\$102.00	\$132.00
J	Less Cylinder, Schlage, 6-pin FSIC	-\$55.00	-\$55.00
□ ● G	With Cylinder, Schlage 7-pin (Everest 29R standard) (factory master keyed only) SFIC	N/A	\$113.00
B	Less Cylinder, Schlage, Falcon, Competitive OEM's, 7-pin (SFIC)	-\$55.00	-\$55.00
L-SAR	Less Cylinder, Sargent (10L + 11L), 6-pin KIL (Only RHO, 8RO, SPA, 8SP, TLR, 8TR, ATH, 8AT lever styles)	No charge	No charge
L-CO6	Less Cylinder, Corbin, 6-pin KIL (Only RHO, 8RO, SPA, 8SP lever styles)	No charge	No charge
J-SAR	Less Cylinder, Sargent 6300, 6-pin FSIC	No charge	No charge
J-CO6	Less Cylinder, Corbin 8000, 6-pin FSIC	No charge	No charge
J-CO7	Less Cylinder, Corbin 8000-7, 7-pin FSIC, (Only RHO, 8RO, SPA, 8SP, TLR and 8TR)	No charge	No charge
J-MED	Less Cylinder, Medeco 32*0201, 6-pin FSIC (Only RHO, 8RO, SPA, 8SP lever styles)	No charge	No charge
J-YA6	Less Cylinder, Yale 1210 or Medeco 31*0100, 6-pin FSIC	No charge	No charge
J-YA7	Less Cylinder, Yale 1220, 7-pin FSIC (Only RHO, 8RO, SPA, 8SP lever styles)	No charge	No charge
L-FA7	Less Cylinder, Falcon, 7-pin, KIL (Only RHO, 8RO, SPA, 8SP lever styles)	No charge	No charge

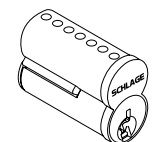
 SFIC Format
B, G

● Master Keyed cylinders can be specified and will be shipped in lock packaging. For Master Keying System Summary form which should accompany the master keyed order, see page 296.

△ For master keying, an additional charge of \$28.30 each applies. Specify line item 50-210.

□ Control keys for installation/removal of interchangeable cores are not furnished and must be ordered separate.

For additional assistance on Master Keying as well as restricted keyways, please contact customer service.



AD-402 NETWORKED WIRELESS EXIT TRIM (FIPS 201-2 COMPLIANT)

9. Select keying type		Price adjustment
Open keyway families: KIL or FSIC⁴		
S123	Everest 29 S (Key in Lever or FSIC)	Standard
C123	Everest C	No charge
C/CE/E/EF/F/FG/G	Classic Obverse	No charge
Restricted keyway families: KIL or FSIC^{4,5}		
29T	Everest 29 T	\$30.00
D	Everest D	\$30.00
Classic Restricted	Quad, Numbered, Reverse	\$30.00
Restricted keyway families: SFIC⁶		
29 R	Everest 29 R	No charge
B	Everest B	No charge

4. Full Size key systems (Everest 29 S and T, Everest C and D, Obverse and Quad) are available in Primus and Primus XP key system and must be ordered separately. Lock should be ordered less cylinder and Primus cylinder should be a separate line.
5. Everest Restricted Keyways require a Letter of Authorization to be submitted with the order. See page 302 for sample Letter of Authorization.
6. Master Keyed cylinders can be specified and will be shipped in lock packaging. For Master Keying System Summary form which should accompany the master keyed order, see page 296.

10. Select handing (field reversible)		Price adjustment
RHR	Right handed reverse	No charge
LHR	Left handed reverse	No charge

11. Select battery		Price adjustment
LLL	Less Battery Holder, batteries, and cover	-\$36.40
4B	4AA Battery kit	Standard
8B	8AA Battery kit	\$54.90

12. – 13. No selection required

14. Select door thickness		Price adjustment
134	1-3/4"	Standard
Example 200	1-3/4" to 2-3/4", (Specify in 1/8" increments)	\$83.00

15. Select options		Price adjustment
LRX	Less Von Duprin low current Request-To-Exit switch	-\$73.00
BAA ⁷	BAA Compliant product	\$125.00

7. BAA compliant products must have the cover letter on page 306 included with the order. Failure to use this cover letter will result in the customer receiving non-BAA compliant product with no recourse for an RMA or refund. BAA compliant product requires a longer lead time, please contact customer service for details.
8. Connections other than Wiegand or Clock & Data may incur additional fee. Consult access control software provider for details.
9. PIM400 required for connection to ACP; sold separately.
- PIM400-TD2 required for Wiegand or Clock & Data connection, see page 136.
 - If RS485 connection to other ACP is required, contact software provider.
10. AD-402 Exit trim comes with a universal mounting plate and is compatible with Von Duprin Series 98/99, 98/99XP, 22/22F exit devices and Falcon 25 rim exit devices with proper low current Request-To-Exit switch (RX-LC). Concealed Vertical Rod and Concealed Vertical Cable trim on metal door only. **When Request-to-exit is required, the Von Duprin RX-LC switch (part #050281) or Falcon AE switch (part #650359) must be used or the Warranty is void.**

Standard accessories available, see pages 133–138.

AD Series Non-Functioning "Dummy" Exit trim now available. Please see pages 131–132 for details.

AD-993
NON-FUNCTIONING DUMMY TRIM FOR EXIT

1-4. Select chassis/exit trim type/reader (Note: See page 88 for exit device compatibility.)		Price
AD-993LLL	Dummy Trim Less Reader for Exit Rim / Concealed Vertical Rod ¹ / Concealed Vertical Cable / Surface Vertical Rod / Mortise Lock ¹	See page 173
AD-993DT	Dummy Trim with "Dummy" Reader Cover for Exit Rim / Concealed Vertical Rod / Surface Vertical Rod ¹ / Mortise Lock	See page 173

1. Metal door only.

5. Select lever²		Price adjustment
LLL	Less interior and exterior levers	See page 173
SPA	Sparta	See page 173
RHO	Rhodes	See page 173
ATH	Athens	See page 173
TLR	Tubular	See page 173
BRW	Broadway	No charge
BRK	Boardwalk	No charge
LAT	Latitude	No charge
LON	Longitude	No charge

2. Tactile Warning use 8AT for Athens, 8RO for Rhodes, 8SP for Sparta and 8TR for Tubular. \$67.00 per lever. Applied to exterior lever only unless otherwise specified. Not available with 643e finish.

6. Select finish		Price adjustment
626	Satin Chrome	See page 173
605	Bright Brass	See page 173
606	Satin Brass	See page 173
612	Satin Bronze	See page 173
619	Satin Nickel	See page 173
625	Bright Chrome	See page 173
643e	Aged Bronze	See page 173
626AM	Satin Chrome Antimicrobial	See page 173

8. Select cylinder type		Price adjustment	
		Open	Restricted
<input checked="" type="checkbox"/> ● P6	With Cylinder, Schlage - (Everest 29 S123, 6-pin KIL standard)	No charge	\$30.00
<input type="checkbox"/> ● L	Less Cylinder, Schlage, Falcon, 6-pin KIL	-\$90.00	-\$90.00
<input checked="" type="checkbox"/> ● R	With Cylinder, Schlage 6-pin (Everest 29 S123 standard) FSIC	\$102.00	\$132.00
<input type="checkbox"/> ● J	Less Cylinder, Schlage, 6-pin FSIC	-\$55.00	-\$55.00
<input checked="" type="checkbox"/> ● G	With Cylinder, Schlage 7-pin (Everest 29R standard) (factory master keyed only) SFIC	N/A	\$113.00
<input type="checkbox"/> ● B	Less Cylinder, Schlage, Falcon, Competitive OEM's, 7-pin (SFIC)	-\$55.00	-\$55.00
<input type="checkbox"/> ● L-SAR	Less Cylinder, Sargent (10L + 11L), 6-pin KIL (Only RHO, 8RO, SPA, 8SP, TLR, 8TR, ATH, 8AT lever styles)	See page 173	See page 173
<input type="checkbox"/> ● L-CO6	Less Cylinder, Corbin, 6-pin KIL (Only RHO, 8RO, SPA, 8SP lever styles)	See page 173	See page 173
<input type="checkbox"/> ● J-SAR	Less Cylinder, Sargent 6300, 6-pin FSIC	See page 173	See page 173
<input type="checkbox"/> ● J-CO6	Less Cylinder, Corbin 8000, 6-pin FSIC	See page 173	See page 173
<input type="checkbox"/> ● J-CO7	Less Cylinder, Corbin 8000-7, 7-pin FSIC, (Only RHO, 8RO, SPA, 8SP, TLR and 8TR)	See page 173	See page 173
<input type="checkbox"/> ● J-MED	Less Cylinder, Medeco 32*0201, 6-pin FSIC (Only RHO, 8RO, SPA, 8SP lever styles)	See page 173	See page 173
<input type="checkbox"/> ● J-YA6	Less Cylinder, Yale 1210 or Medeco 31*0100, 6-pin FSIC	See page 173	See page 173
<input type="checkbox"/> ● J-YA7	Less Cylinder, Yale 1220, 7-pin FSIC (Only RHO, 8RO, SPA, 8SP lever styles)	See page 173	See page 173
<input type="checkbox"/> ● L-FA7	Less Cylinder, Falcon, 7-pin, KIL (Only RHO, 8RO, SPA, 8SP lever styles)	See page 173	See page 173

● Master Keyed cylinders can be specified and will be shipped in lock packaging. For Master Keying System Summary form which should accompany the master keyed order, see page 296.

△ For master keying, an additional charge of \$28.30 each applies. Specify line item 50-210.

□ Control keys for installation/removal of interchangeable cores are not furnished and must be ordered separate.

For additional assistance on Master Keying as well as restricted keyways, please contact customer service.

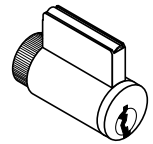
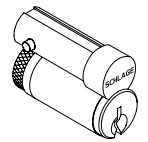
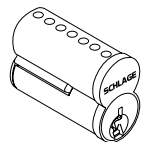
AD-993DT

Full Cylinder
P6, L, L-SAR, L-FA7

SFIC Format
R, J, J-SAR, J-CO6, J-CO7, J-YA6

SFIC Format
B, G

AD-993

NON-FUNCTIONING DUMMY TRIM FOR EXIT

8. Select keying type **Price adjustment**

Open keyway families: KIL or FSIC ³		
S123	Everest 29 S (Key in Lever or FSIC)	See page 174
C/CE/E/EF/F/FG/G	Classic Obverse	See page 174
Restricted keyway families: KIL or FSIC ^{3,4}		
29 T	Everest 29 T	See page 174
D	Everest D	See page 174
Classic Restricted	Quad, Numbered, Reverse	See page 174
Restricted keyway families: SFIC ⁵		
29R	Everest 29 R	See page 174
B	Everest B	See page 174

3. Full Size key systems (Everest 29 S and T, Everest C and D, Obverse and Quad) are available in Primus and Primus XP key system and must be ordered separately. Lock should be ordered less cylinder and Primus cylinder should be a separate line.
4. Everest Restricted Keyways require a Letter of Authorization to be submitted with the order. See page 302 for sample Letter of Authorization.
5. Master Keyed cylinders can be specified and will be shipped in lock packaging. For Master Keying System Summary form which should accompany the master keyed order, see page 296.

9. Select handing (field reversible) **Price adjustment**

RHR	Right handed reverse	See page 174
LHR	Left handed reverse	See page 174

10. – 12. No selection required
13. Select door thickness **Price adjustment**

134	1-3/4"	See page 174
Example 178	1-7/8" to 2-3/4", (Specify in 1/8" increments)	See page 174

14. Select options **Price adjustment**

BAA ⁶	BAA Compliant product	See page 174
------------------	-----------------------	--------------

6. BAA compliant products must have the cover letter on page 306 included with the order. Failure to use this cover letter will result in the customer receiving non-BAA compliant product with no recourse for an RMA or refund. BAA compliant product requires a longer lead time, please contact customer service for details.

Accessories available, see pages 133–138.

Credentials available, see pages 16–20.

AD Series Exit trim

The AD993DT Non-Functioning Dummy Trim comes with a universal mounting plate and is compatible with the following exit devices:

- **Von Duprin 98/99 and 98/99XP**
 - Rim, Concealed Vertical Rod (metal door only), Concealed Vertical Cable (metal door only), Surface Vertical Rod, Mortise. Low current Request-to-Exit Switch optional for future network migration.
- **Von Duprin 22/22F**
 - Rim, Surface Vertical Rod
- **Falcon 25 – Rim**
- **Sargent 80 Series** (Narrow design and reversible rim exits not compatible) – Rim
- **Corbin Russwin 5000 Series – Rim**
- **Yale 7000 – Rim**
- **Dorma 9300 – Rim**
- **Precision 21 – Rim** (2100 converts to 21 with Precision's BP21 Kit)

PARTS AND ACCESSORIES

ANDROID™ CABLE (For use with SUS Android App)			
Product description	Product specification	Specify	Price
USB & 2-PIN Android cable	Used to connect Android device to USB and 2-PIN locks and accessories	47282796 SUS A-KIT	See page 175

HANDHELD DEVICE ACCESSORIES (Legacy product support)			
Product description	Product specification	Specify	Price
Serial cable	Used to connect current model HHD (BM170) directly to legacy serial products without the need of a CIP	HH-2PIN SERIAL	See page 175
Serial cable ¹	Used to connect previous model HHD (BM150) with CIP to program serial products	HH-SERIAL	
Null converter	Used to connect handheld device to WA Series PIM, using HH-SERIAL serial cable (compatible to current and previous model HHDs)	PIMWA-CV	
Computer interface module (CIP) ¹	Used to program serial products using HH-SERIAL serial cable	P512112	
CIP with iButton reader ¹	Used to program serial products using HH-SERIAL serial cable	P101203	

1. Not compatible to current HHD (BM170).

READER MODULES (Select by Technology)	Available finishes										
	605	606	612	613	619	622	625	626	643e	626AM	
Product description	Specify										Price
	Part number	Finish									
Keypad only reader module	▪	▪	▪	▪	▪	▪	▪	▪	▪	▪	See page 175
Magnetic stripe (Insert) reader module - (Track 1, 2, or 3)			N/A		N/A						
Magnetic stripe (Insert) with keypad reader module - (Track 1, 2, or 3)											
Magnetic stripe (Swipe) reader module - (Track 1, 2, or 3)											
Magnetic stripe (Swipe) with keypad reader module - (Track 1, 2, or 3)											
Multi-technology reader module - (125 kHz Proximity and 13.56 MHz Smart)											
Multi-technology with keypad reader module - (125 kHz Proximity and 13.56 MHz Smart)											
Smart technology iClass compatible reader											
Smart technology iClass compatible reader + keypad											
FIPS Multi-technology with keypad reader module - (125 kHz Proximity and 13.56 MHz Smart)											
Dummy trim reader cover											

READER MODULE ACCESSORIES		
Product description	Specify	Price
Magnetic stripe cleaning cards	510310	See page 175

PARTS AND ACCESSORIES

COMMUNICATION MODULE KITS		Available finishes									
		605	606	612	613	619	622	625	626	643e	626AM
		▪	▪	▪	N/A	▪	N/A	▪	▪	▪	▪
Product description	Product specification	Specify		Price							
		Part number	Finish								
AD-200/AD-250 Offline communication kit (Cover)	Storeroom Functions (Cylindrical and Exit Chassis)	COM200C	.[Finish]	See page 176							
AD-200/AD-250 Offline communication kit (Cover with indicator lens) ¹	Privacy/Apartment Functions (Mortise Deadbolt Chassis)	COM200L	.[Finish]								
AD-200/AD-250 Offline communication kit (Cover with push button) ¹	Privacy/Apartment/Office/Classroom Functions (Cylindrical and Mortise Chassis)	COM200P	.[Finish]								
AD-300 Hardwired Communication Kit (Cover with Indicator Lens, RS485 Communication PCB) ^{1,2}	Storeroom Functions (Cylindrical, Mortise and Exit Chassis) Privacy/Apartment Functions (Mortise Deadbolt Chassis)	COM300L	.[Finish]								
AD-300 Hardwired communication kit (Cover with push button, RS485 communication PCB) ^{1,2}	Privacy/Apartment/Office/Classroom Functions (Cylindrical and Mortise Chassis)	COM300P	.[Finish]								
AD-400 Wireless Communication Kit (Cover with indicator lens, 900MHz communication PCB) ^{1,2}	Storeroom Functions (Cylindrical, Mortise and Exit Chassis) Privacy/Apartment Functions (Mortise Deadbolt Chassis)	COM400L	.[Finish]								
AD-400 Wireless communication kit (Cover with push button, 900MHz communication PCB) ^{1,2}	Privacy/Apartment/Office/Classroom Functions (Cylindrical and Mortise Chassis)	COM400P	.[Finish]								

1. Must order and install Door Position Switch #46929121 for proper operation.
2. Must order and install Pigtail Exit Adapter #23536774 for RX-LC switch if retrofitting AD-200-993 to AD-300-993 or AD-400-993.

	Class	Chassis	Type	Storeroom (70)	Office/ Classroom (50)	Apartment (60)	Privacy (40)
OFFLINE	AD-200 and AD-250	CY	Cylindrical	COM200C	COM200P	COM200P	COM200P
	AD-200 and AD-250	MS	Mortise	COM200C	COM200P	COM200P	COM200P
	AD-200 and AD-250	MD	Mortise Deadbolt	N/A	N/A	COM200L	COM200L
	AD-200 and AD-250	993	Exit trim	COM200C	N/A	N/A	N/A
NETWORKED	AD-300	CY	Cylindrical	COM300L	COM300P	COM300P	COM300P
	AD-300	MS	Mortise	COM300L	COM300P	COM300P	COM300P
	AD-300	MD	Mortise Deadbolt	N/A	N/A	COM300L	COM300L
	AD-300	993	Exit trim	COM300L	N/A	N/A	N/A
	AD-400	CY	Cylindrical	COM400L	COM400P	COM400P	COM400P
	AD-400	MS	Mortise	COM400L	COM400P	COM400P	COM400P
	AD-400	MD	Mortise Deadbolt	N/A	N/A	COM400L	COM400L
	AD-400	993	Exit trim	COM400L	N/A	N/A	N/A

Suffixes: C= Cover L= LED Only P= Pushbutton

Note: Connections other than Wiegand or Clock & Data may incur additional fee. Consult access control provider for details.

PARTS AND ACCESSORIES

DOOR POSITION SWITCH		
Description	Specify	Price
Door Position Switch	46929121	See page 193

BATTERY HOLDER AND COVER KIT (Select by Battery Quantity)	Available finishes									
	605	606	612	613	619	622	625	626	643e	626AM
	▪	▪	▪	N/A	▪	N/A	▪	▪	▪	▪
Description	Specify		Price							
	Part number	Finish								
4AA Battery holder and cover kit (Includes 4AA battery holder with cable, 4AA battery strap, battery strap screws, 4AA battery cover, cover screw, Torx® cover screw)	4B (46929055)	.[Finish]	See page 196							
8AA Battery holder and cover kit (Includes 8AA battery holder with cable, 8AA battery strap, battery strap screws, 8AA battery cover, cover screw, Torx cover screw, Mylar)	8B (46929089)	.[Finish]								

BATTERY COVER (Select by Battery Quantity)	Available finishes									
	605	606	612	613	619	622	625	626	643e	626AM
	▪	▪	▪	N/A	▪	N/A	▪	▪	▪	▪
Description	Specify		Price							
	Part number	Finish								
4AA Battery cover (with screw)	4C (46929071)	.[Finish]	See page 196							
8AA Battery cover (with screw)	8C (46929105)	.[Finish]								

TORX® TAMPER SCREW PACK (Select by Chassis Type)		Available finishes									
		605	606	612	613	619	622	625	626	643e	626AM
		▪	▪	▪	N/A	▪	N/A	▪	▪	▪	▪
Chassis	Description	Specify		Price							
		Part number	Finish								
Cylindrical	Torx tamper screw pack	23538812	.[Finish]	See page 197							
Mortise	Torx tamper screw pack	23538820	.[Finish]								
Exit	Torx tamper screw pack	23538838	.[Finish]								

DECORATIVE PLATE (Select by Size)		Available finishes									
		605 ¹	606	612	613	619	622	625	626	643e ¹	626AM
		▪	N/A	N/A	N/A	N/A	N/A	N/A	▪	▪	N/A
Size	Description	Specify		Price							
		Part number	Finish								
1.5" x 3.25" x .105"	Decorative plate (with screws) - (Exit trim)	23631823	.[Finish]	See page 194							
1.7" x 3.5" x .075"	Decorative plate (with screws)	23760267	.[Finish]								
3.2" x 3.5" x .075"	Decorative plate (with screws)	23760283	.[Finish]								
6.0" x 3.5" x .075"	Decorative plate (with screws)	23760317	.[Finish]								
6.6" x 3.5" x .075"	Decorative plate (with screws)	23760325	.[Finish]								
8.0" x 3.5" x .075"	Decorative plate (with screws)	23760309	.[Finish]								
8.0" x 3.5" x .075"	Decorative plate (with screws and welded standoff)	23760291	.[Finish]								
10.5" x 3.5" x .075"	Decorative plate (no screws necessary) - (under lock) ²	23760259 ²	.[Finish]								
12.0" x 3.5" x .075"	Decorative plate (no screws necessary) - (under lock) ²	23760275 ²	.[Finish]								

- 626 Satin Chrome finish standard. Please consult Customer Care for 605 Bright Brass or 643E Aged Bronze.
- Please consider overall Door Thickness when ordering.
- Single Decorative plate. Interior and Exterior Decorative plates may be required.
- Decorative plates may have multiple applications. Please see AD Series Retrofit Template Overlay guide at www.schlage.com/support for more information.

PARTS AND ACCESSORIES

SHIM PLATES		
(Note: Device is 0.063" thick)		
Description	Specify	Price
Interior shim plate - (for AD-200/250/300)	23458607	See page 193
Interior shim plate - (for AD-400)	23458565	
Exterior shim plate	23458599	

INSTALLATION TOOLS		
Description	Specify	Price
Universal clamp <ul style="list-style-type: none"> The universal clamp is necessary when using the remaining products to ensure hole placement accuracy The "Universal" (Clamp and DPS) products are for use in all CO, AD and LE product installations 	40-286	See page 178
AD Series cylindrical lock installation template	40-288	
Universal cylindrical door position switch (DPS) installation template	40-292	
AD Series mortise lock installation template	40-287	
Universal mortise door position switch (DPS) installation template	40-291	

AD-300/302 HARDWIRED ACCESSORIES			
Note: Connections other than Wiegand or Clock & Data may incur additional fee. Consult access control provider for details.			
Panel interface board			
Product description	Product specification	Specify	Price
Panel interface board (supports 2 doors) ¹	Supports up to two AD-300 Locks. Wiegand or Clock & Data output. Includes weatherproof enclosure (7.1" x 7.1"), RS485 input. Requires 12 or 24 VDC Power supply.	PIB300-2D	\$707.00
Relay board (for PIB300-2D or PIM400-TD2)	Optionally used with PIM300-2D or PIM400-TD2 to simplify installation with access control panels that require relays. Configurable for Normally Open or Normally Closed.	RLBD	\$355.00
Miscellaneous			
Product description	Product specification	Specify	Price
Armored door cord	12" x 1/2"	798-12	\$115.50
Armored door cord	18" x 1/2"	798-18	\$146.30

- For BAA compliant PIB300-2D or PIM400-TD2, add \$29.00. Use suffix BAA.
 - BAA compliant products must have the cover letter on page 306 included with the order. Failure to use this cover letter will result in the customer receiving non-BAA compliant product with no recourse for an RMA or refund.
 - BAA compliant product requires a longer lead time, please contact customer service for details.

PARTS AND ACCESSORIES

AD-400/402 WIRELESS ACCESSORIES			
Panel interface module			
Product description	Product specification	Specify	Price
Panel interface module (supports 2 doors)	Wiegand or Clock & Data output. Includes weatherproof enclosure (7.1" x 7.1"), internal antenna with ability to add remote antenna. Requires 12 or 24 VDC power supply. Relay board sold separately.	PIM400-TD2	\$1,242.00
Relay board (for PIB300-2D or PIM400-TD2)	Optionally used with PIM300-2D or PIM400-TD2 to simplify installation with access control panels that require relays. Configurable for Normally Open or Normally Closed.	RLBD	\$355.00
Wireless portable readers			
Product description	Product specification	Specify	Price
Wireless portable signal tester (With dummy trim reader cover)	Handheld, battery-operated signal tester with non-functioning dummy trim reader cover	WPR400-DT	\$1,998.00
Wireless portable reader (With keypad only reader module)	Handheld, battery-operated unit with keypad only reader module	WPR400-KP	\$2,754.00
Wireless portable reader (With magnetic stripe [insert] reader module)	Handheld, battery-operated unit with magnetic stripe (Insert) reader module.	WPR400-MG	\$2,917.00
Wireless portable reader (With magnetic stripe [insert] with keypad reader module)	Handheld, battery-operated unit with magnetic stripe (Insert) with keypad reader module	WPR400-MGK	\$3,024.00
Wireless portable reader (With magnetic stripe [swipe] reader module)	Handheld, battery-operated unit with magnetic stripe (Swipe) reader module	WPR400-MS	\$2,714.00
Wireless portable reader (With magnetic stripe [swipe] with keypad reader module)	Handheld, battery-operated unit with magnetic stripe (Swipe) with keypad reader module	WPR400-MSK	\$2,903.00
Wireless portable reader (With multi-technology reader module)	Handheld, battery-operated unit with Multi-technology reader module	WPR400-MT	\$3,003.00
Wireless portable reader (With multi-technology with keypad reader module)	Handheld, battery-operated unit with Multi-technology with keypad reader module	WPR400-MTK	\$3,053.00
Wireless portable reader (with Smart-Technology iClass reader module)	Handheld, battery operated unit with Smart-Technology iClass compatible reader module	WPR400-SI	\$3,148.00
Wireless portable reader (with Smart-Technology iClass keypad reader module)	Handheld, battery operated unit with Smart-Technology iClass compatible with keypad reader module	WPR400-SIK	\$3,197.00
Wireless portable reader (with FIPS Multi-technology with keypad reader module)	Handheld, battery-operated unit with FIPS Multi-technology with keypad reader module	WPR401-FMK	\$3,458.00
WPR400/TK400 Battery conversion kit (includes 8AA batteries, 8AA battery holder w/appropriate mounting hardware pre-mounted in a new base)	Converts from the proprietary battery pack to 8 off-the-shelf AA batteries	24885600	\$148.00

PARTS AND ACCESSORIES

AD-400 WIRELESS ACCESSORIES (CONTINUED)			
Control kits			
Product description	Product specification	Specify	Price
Elevator control kit	Includes WRI400, PIM400-TD2, ANT400-REM-I/O, 12 VDC Power Supply	ECK400	\$4,345.00
Gate control kit	Includes WRI400, PIM400-TD2, ANT400-REM-I/O, MGB+MCA5, 12 VDC Power Supply	GCK400	\$4,539.00
Wireless test kit			
Product description	Product specification	Specify	Price
Wireless test kit	Pre-Installed Test Kit; Complete with WPR400-DT, PIM400-TD2, 593PI Power Supply, Charger, Carrying Case	TK400	\$2,603.00
Wireless repeater kit			
Product description	Product specification	Specify	Price
Wireless repeater kit	Complete with PIM400-TD2 and WRI400	REPTR400	\$2,896.00
Remote antennas			
Product description	Product specification	Specify	Price
Omni-directional remote indoor/outdoor antenna module ¹	Includes Antenna, 15' coax, coax whip, articulated wall/post mounting hardware	ANT400-REM-I/O	\$838.50
Directional remote indoor/outdoor antenna module with 6dB Gain ¹	Includes Antenna, 15' coax, coax whip, articulated wall/post mounting hardware	ANT400-REM-I/O+6DB	\$807.70
Omni-directional remote indoor/outdoor antenna module ²	Includes Antenna, 15' coax, coax whip	ANT400-REM-CEILING	\$615.90
Bi-directional remote indoor antenna module ²	Includes Antenna, 15' coax, coax whip	ANT400-REM-HALL	\$878.70
Antenna grounding kit			
Product description	Product specification	Specify	Price
Antenna grounding kit (for outdoor mounting)	May be used with ANT400-REM-I/O, ANT400-REM-I/O+6DB, ANT400-REM-CEILING, ANT400-REM-HALL	MGB+MCA5	\$289.00
Power supply			
Product description	Product specification	Specify	Price
120 VAC to 12 VDC Power supply	Used to power PIM-TD2, PIM-TD4, PIM-EXP, WRI-OTD-12 VDC, and WRI-IN-12 VDC as well as PIM400 and WRI400	593PI-12DC	\$182.30

1. For indoor use with PIM400 and/or WRI400. Requires MGB+MCA5 Antenna grounding kit for outdoor applications.
2. For indoor use with PIM400 and/or WRI400.

Note: Connections other than Wiegand or Clock & Data may incur additional fee. Consult access control provider for details.

Contents

AD Series Standalone | Overview.....141
 How to order.....142
 Class and chassis.....143
 Exit device compatibility.....144
AD Series Standalone | Functions.....144
AD Series Standalone | Readers.....145
AD Series Standalone | Styles146
AD Series Standalone | Configure a product 147
 Cylinders.....148
 Key systems.....149
 Handing.....149
 Battery.....149
 Backset and latchbolt (Cylindrical chassis).....150
 Mortise lock armor front (Mortise/Mortise deadbolt chassis) 151
 Strike plates (Cylindrical chassis)152
 Door dimensions.....153
AD-200 Standalone hardwired 154
 Cylindrical.....154
 Mortise/mortise deadbolt157
 Exit trim.....160
AD-201 Standalone hardwired (FIPS Compliant)163
 Cylindrical.....163
 Mortise/mortise deadbolt165
 Exit trim.....167
AD-250 Standalone, Rights on card169
 Cylindrical.....169
 Mortise/mortise deadbolt171
 Exit trim.....173
AD-993 Non-functioning dummy trim 175
AD Series Standalone | Accessories177
AD Series Standalone | Parts.....181

Finish codes and descriptions

BHMA code	Description
605	Bright brass
606	Satin brass
612	Satin bronze
619	Satin nickel
625	Bright chromium plated
626	Satin chrome
626AM	Satin stainless steel, antimicrobial
643e	Aged bronze

Customer service	Technical support
<ul style="list-style-type: none"> Order status Credit returns of non-defective products General sales questions <p>USA Allegion_Orders@allegion.com CAN Canada.CustomerService@allegion.com</p>	<ul style="list-style-type: none"> Technical questions/issues Returns of defective products Repairs <p>USA Electronic_Lock_TechProdSupport@allegion.com CAN Canada.TechServices@allegion.com</p>



NETWORKED LOCKS

STANDALONE LOCKS



PARTS

How to order AD Series Standalone locks



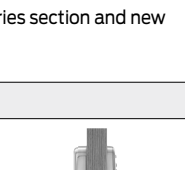

		REQUIRED FIELDS				FACTORY DEFAULT AND OPTIONS											
		AD	200	CY	70	MG	SPA	626	P6	S123	RH	4B	13-247	10-025	134	BAA	
1. Series																	
2. Class																	
200	Rights on lock																
201	FIPS Compliant																
250	Rights on magnetic card																
3. Chassis																	
CY	Cylindrical																
MS	Mortise																
MD	Mortise Deadbolt																
993R	Exit trim - Rim/CVR/CVC																
993S	Exit trim - SVR																
993M	Exit trim - Mortise																
993DT	Dummy Exit trim																
4. Function																	
70	Storeroom	40	Privacy														
50	Office/Classroom	60	Apartment														
5. Reader																	
KP	Keypad																
MGK	Magnetic stripe + Keypad (Insert)																
MG	Magnetic stripe (Insert)																
MSK	Magnetic stripe + Keypad (Swipe)																
MS	Magnetic stripe (Swipe)																
MTK	Multi-Technology + Keypad																
MT	Multi-Technology																
FMK	FIPS 201-2 Compliant Multi-Technology + Keypad																
6. Lever*																	
SPA	Sparta	ATH	Athens														
RHO	Rhodes	TLR	Tubular														
* To add tactile warning, use prefix 8. Example: 8SP																	
7. Finish																	
605	Bright Brass	625	Bright Chrome														
606	Satin Brass	626	Satin Chrome														
612	Satin Bronze	643e	Aged Bronze														
619	Satin Nickel	626AM	Satin Chrome (Antimicrobial Coating)														
8. Cylinder type																	
P6	Schlage 6-pin Full Cylinder																
For all options see individual Class/Chassis page																	
9. Keyway type																	
S123	Everest 29																
For all options see individual Class/Chassis page																	
10. Handing																	
RH	Right handed	RHR	Right handed reverse														
LH	Left handed	LHR	Left handed reverse														
11. Battery holder																	
4B	4AA Battery kit	8B	8AA Battery kit														
12. Backset & latch or Armor front																	
13-247	2-3/4" Backset, deadlatch, square corner, 1-1/8" x 2-1/4" (Std. on CY Chassis)																
09-663	Armor front, 1-1/4" wide, square corner (Std. on MS Chassis)																
For all options see individual Class/Chassis page																	
13. Strike																	
10-025	1-3/16" Lip, ANSI, no box, 1-1/4" x 4-7/8" (Std. on CY Chassis)																
10-072	1-3/16" Lip, 1-1/4" x 4-7/8" square corner, box (Std. on MS Chassis)																
For all options see individual Class/Chassis page																	
14. Door thickness																	
134	1-3/4" (Std.)																
For all options see individual Class/Chassis page																	
15. Additional options																	

AD SERIES STANDALONE LOCKS

- With the AD Series, one platform translates to an endless number of adaptable solutions. You can choose the features and functions that are right for the application today, and upgrade to meet your evolving needs in the future.

CLASS		
AD-200	Standalone, User Rights on the Lock. Computer or Manually Programmable. Keypad, Multi-technology or Magnetic stripe reader options available.	
AD-201	FIPS 201-2 Compliant Standalone, User Rights on the Lock. Computer Programmable with FIPS 201-2 Compliant multi-technology reader.	
AD-250	Standalone, user rights on magnetic stripe card. Computer programmable. Magnetic stripe or magnetic stripe + keypad reader options available.	

- AD-Series locks are upgradable from standalone to networked by applying a communication module available in the accessories section and new firmware available on www.schlage.com/support.

CHASSIS		
CY: Cylindrical	Bored lock installed into round hole in the door	
MS: Mortise	Lock case installed into a mortise rectangular "pocket" in the door	
MD: Mortise Deadbolt	Mortise lock with built-in interconnected auxiliary deadbolt	
993R: Exit Trim	Rim/Concealed Vertical Rod* (CVR) & Concealed Vertical Cable* (CVC) * Metal door only	
993M: Exit Trim	Mortise	
993S: Exit Trim	Surface Vertical Rod (SVR)	
993DT: Exit Trim	Non-Functioning "Dummy" Exit Trim	

- Exit trim utilizes universal hardware to simplify installation to a variety of exit device. AD Series networked locks require a Request-to-Exit switch, please see compatibility chart on next page.







EXIT DEVICE COMPATIBILITY		Exit trim utilizes universal hardware to simplify installation to a variety of exit devices			
Brand	Compatible exit devices	Rim	SVR	CVR/CVC ³	Mortise
Von Duprin	98/99 and 98/99XP	●	●	●	●
Von Duprin	22/22F	●	●		
Falcon	25	●			
Corbin Russwin®	5000	●			
Precision™	21 ⁴	●			
Yale®	7000	●			
Dorma®	9300	●			
Sargent®	80 ⁵	●			

- AD-200 and 250 Offline locks only.
- 3. Metal door only.
- 4. 2100 converts to 21 with Precision's BP21 kit.
- 5. Narrow design and reversible rim exits not compatible.

FUNCTIONS

		AD-200/201	AD-250
70: Storeroom	Lockset is normally secure. Inside lever always allows free egress. Valid toggle credentials on the exterior may be used to change to a passage or secured status.		
50: Office/ Classroom	Lockset is normally secure. Inside lever always allows free egress. Interior pushbutton on inside housing may be used to select a passage or secured status. Meets need for lockdown function for safety and security. NOTE: Valid toggle credentials on the exterior may also be used to change status. Has interior pushbutton (IPB).		
40: Privacy	Lockset is normally secure. Inside lever always allows free egress. Interior pushbutton on inside housing may be used to select a privacy status. The interior pushbutton will disable normal electronic access from the exterior. Opening the door or pressing the interior pushbutton a second time on the inside housing deactivates the privacy status. Has interior pushbutton (IPB).		
60: Apartment	Lockset is normally secure. Inside lever always allows free egress. Interior-pushbutton on inside housing may be used to select a passage or secured status. Opening the door or pressing the interior pushbutton causes the lockset to toggle unsecured. While toggled unsecured, the lockset can only be secured while the door is closed by pressing the interior pushbutton or using a normal credential on the exterior. Normal electronic access from the exterior is always allowed. Has interior pushbutton.		

READER

KP: Keypad	12 button design	
MGK: Magnetic Stripe + Keypad (Insert)	Configurable to read the complete Track 1, 2 or 3. Available with and without 12 button keypad.	
MG: Magnetic Stripe (Insert)		
MSK: Magnetic Stripe + Keypad (Swipe)		
MS: Magnetic Stripe (Swipe)		
MTK: Multi-Technology + Keypad		Single solution that reads 125 kHz proximity and 13.56 MHz smart credentials. Available with and without 12-button keypad
FMK: FIPS 201-2 Compliant Multi-Technology + Keypad		
MT: Multi-Technology		
Si/SiK: Smart iClass Compatible Reader	13.56 MHz smart card credential solution compatible with Schlage MIFARE, HID iClass, iClass SE, and SEOS technologies. Available with and without 12-button keypad.	

1. Please refer to AD-Series data sheets and solution sheets prior to ordering to verify credential compatibility.
2. FMK reader now sold separately for field upgrades.
3. Must specify finish when ordering reader separately. KP, MGK, MG, MSK & MS readers available in 626, 605, 606, 612, 619, 625 & 643e. MT, MTK & FMK readers are available in Grey (for 619, 626, 626AM & 625) and available in Brown (for 605, 606, 612 & 643e).

LEVER DESIGNS
ATHENS (ATH)²

Tactile option: 8AT (knurled)

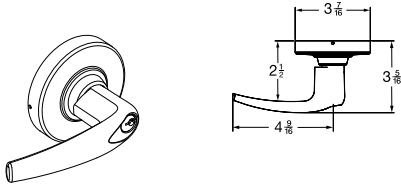
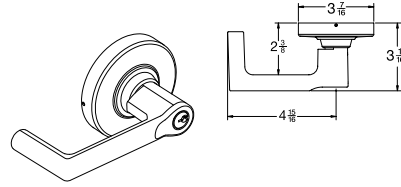
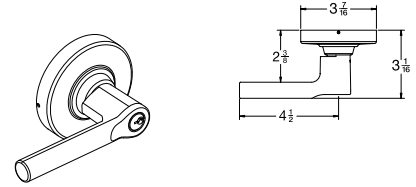
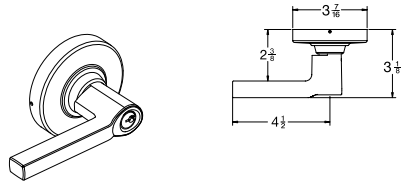
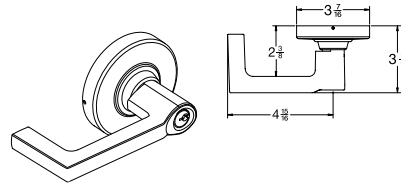
BOARDWALK (BRK)

BROADWAY (BRW)

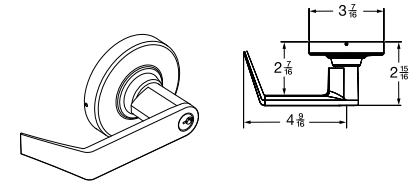
LATITUDE (LAT)

LONGITUDE (LON)

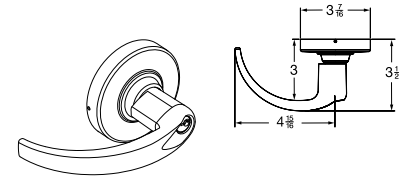
RHODES (RHO)

Tactile option: 8RO (knurled)

SPARTA (SPA)²

Tactile option: 8SP (knurled)

TUBULAR (TLR)²

Tactile option: 8TR (knurled)

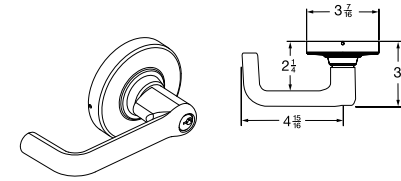

1. All lever designs are available in finishes 605, 606, 612, 619, 625, 626, 643E and 626AM.
2. ATH, SPA, and TLR levers meet California Fire Code for 1/2" or less return to door.
3. Changing lever cylinder compatibility on a device typically requires replacement of existing spring cage and tailpiece.
4. Tactile warning is applied to exterior lever only unless otherwise specified. Not available with 643e finish.
5. AD Series, CO Series, and ND Series levers may be interchangeable in some cases depending whether it is an interior or exterior lever, the type of chassis, and the type of cylinder/spring cage/tailpiece. Please consult the [AD Series Parts Guide](#) for more information.

FINISH CHART

Finish description	Finish No.	BHMA No.	Government
Bright Brass	605	605E	US3
Satin Brass	606	606E	US4
Satin Bronze	612	612E	US10
Satin Nickel	619		
Bright Chrome	625	625E	US26
Satin Chrome	626	626E	US26D
Satin Chrome Antimicrobial	626AM		

 Please refer to the Electronic Access Control catalog or online product information at us.allegion.com to view each finish.

You can **configure and price a full range of products** using the tables and rules shown in this section.

The pricing of locks in this section includes the P6 cylinder in an open keyway (where applicable), default latch, strike and a 1-3/4" thick door. Additional modifications are available using the rules and price adjustments on the subsequent pages.

How to order:

- All applicable product attributes must be provided in the order shown below
- Each value must be separated by a period
- If requesting a product "Less (LLL)" any attribute, the entire detailed ACN must be provided
- Fractions will be written with the "/" symbol separating the numerator and the denominator (example 1/2)
- For dimensions that contain a whole number and a fraction, a hyphen "-" will be added after the whole number and before the fraction (example 2-1/4)
- For two dimensions represented together, such as length and width, the values would be separated by an "x" with no spaces
- Finishes should be listed using their BHMA finish as shown in this book

Quantity	Brand	Series	Class + Chassis	Function	Reader	Lever style	Finish	Cylinder	Handing	Battery	Backset & latch or Armor front	Strike	Door dimensions			Options			Keying		
													Door thickness	Extended	Strike lip length	Latch extension	Box for ANSI strike	Rabbeted latch and strike kit	Buy America Act compliant	Keying code	Keyway
1	2	3	4	5	6	7	8	9	10	11	12	13A	13B	13C	14A	14B	14C	14D	15A	15B	15C

Required for all lock orders

Only required when deviating from the product's default. Specify only the deviated attribute(s).

Only required when deviating from the product's default. Specify only the deviated attribute(s).

If ordering a product "Less (LLL)" any attribute, values for each attribute must be provided.

EXAMPLE:

AD . 200CY . 70 . KP . LAT . 626 . P6 . RH . **8B**

| 2 | 3 | 4 | 5 | 6 | 7 | 8 | 9 | 10

Battery deviates from the product default

COMPLETE LOCKS

CYLINDERS

Keyed locks are priced including the P6 cylinder with open keyway. Provided below are pricing adjustments based on other available cylinder types. For Primus and Primus XP cylinders, order lock less cylinder and order the Primus or Primus XP cylinder separately.

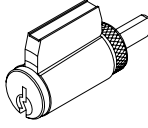
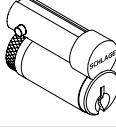
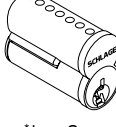
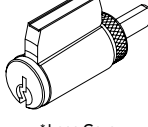
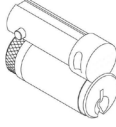
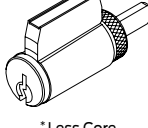
CYLINDERS		
P6	Conventional 6-pin cylinder	
L	Less conventional cylinder	
R	FSIC (Full size interchangeable core)	
J	Less FSIC	
G	SFIC (Small format interchangeable core) 7-pin	 * Less Core
B	Less SFIC	
L-SAR ⓧ	Less cylinder, Sargent® (10L+11L) 6-pin Key-in-Lever (KIL)	 * Less Core
L-CO6 ⓧ	Less cylinder, 6-pin Key-in-Lever (KIL)	
JDSAR ⓧ	Less cylinder, Sargent 6300; 6-pin FSIC	 * Less Core
J-CO6 ⓧ	Less cylinder, Corbin Russwin® 8000; 6-pin FSIC	
J-CO7 ⓧ	Less cylinder, Corbin Russwin 8000-7; 7-pin FSIC (Only RHO, 8RO, SPA, 8SP, TLR, 8TR)	
J-MED ⓧ	Less cylinder, Medeco 32*0201®; 6-pin FSIC	
J-YA6 ⓧ	Less cylinder, Yale® 1210 or Medeco 31*0100; 6-pin FSIC	
J-YA7 ⓧ	Less cylinder, Yale 1220; 7-pin FSIC	 * Less Core
L-FA7	Less cylinder, Falcon 7-pin Key-in-Lever (KIL) (Only RHO, 8RO, SPA, 8SP lever styles)	

ⓧ Extended lead time

1. Competitor lever designs come in finishes 626 standard, and 605, 606, 612, 619, 625, 643e, and 626AM with extended lead-times.
2. For P, R and G -Master Keyed cylinders can be specified and will be shipped in lock packaging.
3. For Master Key System Summary form which should accompany the master keyed order, see pages 296–301.
4. For Master Keying, additional line item 50-210 is required for Classic and Everest cylinders.
5. Control Keys for installation/removal of interchangeable cores are not furnished and must be ordered separate.
6. For additional assistance on Master Keying as well as restricted keyways please contact your local sales representative.
7. Spring cages and tailpieces are different based on the type of cylinder and chassis selected. Please see the [AD Series Parts Guide](#) for more information.
8. The AD Series accepts many popular models of standard, SFIC, and FSIC cylinders. Consult the [Keyway/Cylinder Compatibility Data Sheet](#) (010432) for details. See price book for specific configurations.

COMPLETE LOCKS

KEY SYSTEMS

KEY SYSTEMS AVAILABLE THROUGH SCHLAGE		
Default	Keyway family	Description
▪	Everest 29™ S Keyway Family	Patent protected open keyways that are available in full size Key In Lever (KIL) and Full Size Interchangeable Core (FSIC) formats. Patent protection through 2029.
	Everest 29 T Keyway Family	Patent protected restricted keyways that are available in full size KIL and FSIC formats. Patent protection through 2029.
	Everest D Keyway Family	Restricted keyways that are available in full size KIL and FSIC formats.
	Everest C Keyway Family	Open keyways that are available in full size KIL and FSIC formats.
	Schlage Classic Open Keyways	Classic (C/E/F): Open keyways available in KIL and FSIC designs
	Everest B Keyway Family	Restricted keyways that are available on Small Format Interchangeable Core (SFIC).
	Everest 29 R Keyway Family	Patent protected restricted keyways that are available on SFIC. Patent protection through 2029.

- Everest Restricted Keyways require a Letter of Authorization to be submitted with the order. See sample Letter of Authorization on page 302.
- Full Size key systems (Everest 29 S and T, Everest C and D, Obverse and Quad) are available in Primus and Primus XP key system and must be ordered separately. Lock should be ordered less cylinder and Primus cylinder should be a separate line.

Contact your local RSO representative for assistance in determining which format and level of exclusivity best suits your needs.

COMPLETE LOCKS

HANDING

HANDING		
RH	Right handed: Hinges on right opens inward	<p>The diagram illustrates four handing configurations for the lock. The top two configurations (RH and LH) show inward-opening hinges, while the bottom two (RHR and LHR) show outward-opening hinges. Labels indicate 'INSIDE' and 'OUTSIDE' directions and specify hinge locations (left or right).</p>
LH	Left handed: Hinges on left opens inward	
RHR	Right handed reverse: Hinges on right opens outward	
LHR	Left handed reverse: Hinges on left opens outward	

- Exit trim 993 chassis available only with RHR or LHR option.
- Handing is field reversible, but requires removal of the exterior escutcheon cover. Please see AD Series installation instructions for details.

COMPLETE LOCKS

BATTERY

BATTERY		
4B	4AA Battery holder and cover kit	
8B	8AA Battery holder and cover kit	

AD-Series locks use standard off-the-shelf AA batteries.

COMPLETE LOCKS

BACKSET AND LATCHBOLT (CYLINDRICAL CHASSIS)

LATCHES		
13-247	2-3/4" Backset Deadlatch Square corner, 1-1/8" x 2-1/4"	
14-049	2-3/4" Backset Deadlatch Anti-friction fire door latch, Square corner, 1-1/8" x 2-1/4", 3/4" throw	
14-051	2-3/8" Backset Deadlatch Square corner, 1-1/8" x 2-1/4"	
14-050	3-3/4" Backset Deadlatch Square corner, 1-1/8" x 2-1/4"	
43-001	5" Backset extension link Deadlatch	
39-030	Rabbeted latch and strike kit, 605 and 626 only. Adapts square corner latch and 2-3/4" square corner strike to 1/2" rabbeted door and frame.	No image available

NETWORKED LOCKS



STANDALONE LOCKS

PARTS

COMPLETE LOCKS

MORTISE LOCK ARMOR FRONT (MORTISE/MORTISE DEADBOLT CHASSIS)

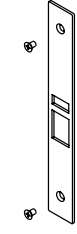
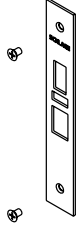
- For 1-3/4" thick doors, use wide armor front. For over 1-3/4" thick door extended equally (EE), use 1-1/4" wide armor front.
- Available finishes are 605, 606, 612, 619, 625, and 626.

ARMOR FRONT		
09-663	1-1/4" Wide square corner, latch for MS	
09-669	1-1/16" Wide square corner, latch, options for MS	
09-666	1-1/4" Wide square corner, latch x deadbolt for MD	
09-672	1-1/16" Wide square corner, latch x deadbolt, options for MD	

Images not shown to scale. Consult [AD Series Parts Guide](#) for more information.

COMPLETE LOCKS

STRIKE PLATES (CYLINDRICAL CHASSIS)

STRIKES WITH LOCKS		
10-025	1-3/16" Lip, ANSI, no box, 1-1/14" x 4-7/8",	
10-013	1-1/8" Lip, square corner, T-strike, box, 1-1/8" – 2-3/4", 1-1/2" Lip available, must specify 1-1/2" Lip	
10-016	1-1/8" Lip, square corner, T-strike, deep box, fire door latch	
K510-066	Box for ANSI strike (Must be specific)	
10-072	1-3/16" Lip, 1-1/4" x 4-7/8", square corner, box	
	7/8", 1", 1-1/2", 1-3/4", or 2" Lip, 1-1/4" x 4-7/8", square corner, box	
10-075	1/2" Rabbeted, For 1-3/4" thick doors, use wide armor front. For over 1-3/4" thick door extended equally (EE) use 1-1/4" wide armor front.	
37-015	Strike frame reinforcer, specify 37-015	
XL11-820	One hole for latching functions, RH & LHR doors Lip 1-3/16"	
XL11-821	One hole for latching functions, LH & RHR doors Lip 1-3/16"	
XQ07-351-134 ⓘ	Strike, ANSI, No Box, 1-1/4" x 4-7/8", 1-3/4" Lip Length	Image not available
XQ03-494-134 ⓘ	Strike, square corner, T-strike, box, 1-1/8" x 2-3/4", 1-3/4" Lip	Image not available

ⓘ XL11-820 and XL11-821 Extended lead time; contact customer service.



COMPLETE LOCKS

DOOR DIMENSIONS

DOOR THICKNESS

- Specify door thickness on order only if different than 1-3/4" thick door
- Door thickness should be specified to the nearest 1/8"

DOOR THICKNESS	
1-3/4"	1-3/4"
1-3/8"	1-3/8" to 2-3/4", Shims included (Specify in 1/8" increments)

1. Door thickness kits are available on page 194 to install a lock on a door that is thicker or thinner than 1-3/4". See [AD Series Parts Guide](#) for details. Locks cannot be installed on doors thicker than 2-3/4" or thinner than 1-3/8".
2. Thin door shims are available on page 194 to install a lock on a door that is thinner than 1-3/4".
3. Decorative plates are used to cover exposed holes when retrofitting from existing locks to AD Series locks. The size of plate required will vary based on the size and location of holes being covered. Retrofit information can be found at www.schlage.com/support.
4. If under the lock decorative plates are on both sides of device, then door will become 1/8" thicker. A door thickness kit of an incremental 1/8" must be ordered to accommodate under the lock plates.

- CREENTIALS
- READERS
- READER CONTROLLERS
- MULTI-FAMILY
- ENGAGE
- AD SERIES
- CO SERIES
- ELECTROMAGNETIC LOCKS
- POWER SUPPLIES
- VON DUPRIN ACCESS CONTROL
- SYSTEM ACC
- MISC

AD-200 STANDALONE HARDWIRED

CYLINDRICAL

1-4. Select chassis/function
Price

AD-200-CY-70 ¹	Storeroom	\$2,596.00
AD-200-CY-50 ¹	Office/Classroom	\$2,606.00
AD-200-CY-40	Privacy	\$2,606.00
AD-200-CY-60	Apartment	\$2,606.00

1. Less Door Position Switch, use suffix LDP. -\$27.00

5. Select reader

(Note: Reflects price adder to base keypad reader price of \$741.00)

Price adjustment

LLL ²	Less Reader	-\$741.00
KP	Keypad	Standard
MS	Magnetic Stripe (Swipe)	\$139.00
MSK	Magnetic Stripe (Swipe) + Keypad	\$229.00
MG	Magnetic Stripe (Insert)	\$160.00
MGK	Magnetic Stripe (Insert) + Keypad	\$255.00
MT	Multi-Technology Proximity and Smart Card	\$275.00
MTK	Multi-Technology + Keypad Proximity and Smart Card	\$364.00

2. For reader module accessories sold separately, see page 175.

6. Select lever³
Price adjustment

LLL	Less each lever	-\$65.20
Standard options	SPA (Sparta), RHO (Rhodes), ATH (Athens), TLR (Tubular), BRW (Broadway), BRK (Boardwalk), LAT (Latitude), LON (Longitude)	No charge

3. Tactile Warning use 8AT for Athens, 8RO for Rhodes, 8SP for Sparta and 8TR for Tubular. \$67.00 per lever. Applied to exterior lever only unless otherwise specified. Not available with 643e finish.

7. Select finish
Price adjustment

626	Satin Chrome	No charge
605	Bright Brass	\$166.00
606	Satin Brass	\$166.00
612	Satin Bronze (00C rose not available in 612 finish)	\$166.00
619	Satin Nickel	\$166.00
625	Bright Chrome	\$166.00
643e	Aged Bronze	\$166.00
626AM	Satin Chrome Antimicrobial	\$215.00



AD-200-CY-70-KP



MG



MGK



MS



MSK



MT/SI



MTK/SIK/FMK

NETWORKED LOCKS

STANDALONE LOCKS

PARTS

AD-200 STANDALONE HARDWIRED
CYLINDRICAL

		Price adjustment	
		Open	Restricted
8. Select cylinder type			
<input type="checkbox"/> ● P6	With Cylinder, Schlage - (Everest 29 S123, 6-pin KIL standard)	No charge	\$30.00
L	Less Cylinder, Schlage, Falcon, 6-pin KIL	-\$90.00	-\$90.00
<input type="checkbox"/> ● R	With Cylinder, Schlage 6-pin (Everest 29 S123 standard) FSIC	\$102.00	\$132.00
J	Less Cylinder, Schlage, 6-pin FSIC	-\$55.00	-\$55.00
<input type="checkbox"/> ● G	With Cylinder, Schlage 7-pin (Everest 29R standard) (factory master keyed only) SFIC	N/A	\$113.00
B	Less Cylinder, Schlage, Falcon, Competitive OEM's, 7-pin (SFIC)	-\$55.00	-\$55.00
L-SAR	Less Cylinder, Sargent (10L + 11L), 6-pin KIL (Only RHO, 8RO, SPA, 8SP, TLR, 8TR, ATH, 8AT lever styles)	No charge	No charge
L-CO6	Less Cylinder, Corbin, 6-pin KIL (Only RHO, 8RO, SPA, 8SP lever styles)	No charge	No charge
J-SAR	Less Cylinder, Sargent 6300, 6-pin FSIC	No charge	No charge
J-CO6	Less Cylinder, Corbin 8000, 6-pin FSIC	No charge	No charge
J-CO7	Less Cylinder, Corbin 8000-7, 7-pin FSIC, (Only RHO, 8RO, SPA, 8SP, TLR and 8TR)	No charge	No charge
J-MED	Less Cylinder, Medeco 32*0201, 6-pin FSIC (Only RHO, 8RO, SPA, 8SP lever styles)	No charge	No charge
J-YA6	Less Cylinder, Yale 1210 or Medeco 31*0100, 6-pin FSIC	No charge	No charge
J-YA7	Less Cylinder, Yale 1220, 7-pin FSIC (Only RHO, 8RO, SPA, 8SP lever styles)	No charge	No charge
L-FA7	Less Cylinder, Falcon, 7-pin, KIL (Only RHO, 8RO, SPA, 8SP lever styles)	No charge	No charge

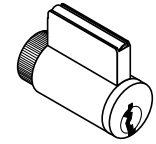
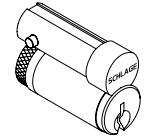
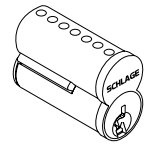
Full Cylinder
P6, L, L-SAR, L-FA7

FSIC Format
R, J, J-SAR, J-CO6, J-CO7, J-YA6

SFIC Format
B, G

● Master Keyed cylinders can be specified and will be shipped in lock packaging. For Master Keying System Summary form which should accompany the master keyed order, see page 296.

△ For master keying, an additional charge of \$28.30 each applies. Specify line item 50-210.

□ Control keys for installation/removal of interchangeable cores are not furnished and must be ordered separate.

For additional assistance on Master Keying as well as restricted keyways, please contact customer service.

9. Select keying type		Price adjustment
Open keyway families: KIL or FSIC⁴		
S123	Everest 29 S (Key in Lever or FSIC)	Standard
C123	Everest C	No charge
C/CE/E/EF/F/FG/G	Classic Obverse	No charge
Restricted keyway families: KIL or FSIC^{4,5}		
29T	Everest 29 T	\$30.00
D	Everest D	\$30.00
Classic Restricted	Quad, Numbered, Reverse	\$30.00
Restricted keyway families: SFIC⁶		
29 R	Everest 29 R	No charge
B	Everest B	No charge

4. Full Size key systems (Everest 29 S and T, Everest C and D, Obverse and Quad) are available in Primus and Primus XP key system and must be ordered separately. Lock should be ordered less cylinder and Primus cylinder should be a separate line.

5. Everest Restricted Keyways require a Letter of Authorization to be submitted with the order. See page 302 for sample Letter of Authorization.

6. Master Keyed cylinders can be specified and will be shipped in lock packaging. For Master Keying System Summary form which should accompany the master keyed order, see page 296.

10. Select handing (field reversible)		Price adjustment
RH	Right handed	No charge
LH	Left handed	No charge
RHR	Right handed reverse	No charge
LHR	Left handed reverse	No charge



AD-200 STANDALONE HARDWIRED

CYLINDRICAL

11. Select battery **Price adjustment**

LLL	Less Battery Holder, batteries, and cover	-\$36.40
4B	4AA Battery kit	Standard
8B	8AA Battery kit	\$54.90

12. Select backset and latch bolt **Price adjustment**

LLL	Less Latch	-\$48.00
13-247	2-3/4" Backset, deadlatch, square corner, 1-1/8" x 2-1/4"	Standard
14-049	2-3/4" Backset, deadlatch anti-friction fire door latch, square corner, 1-1/8" x 2-1/4", 3/4" throw	\$254.00
14-051	2-3/8" Backset, deadlatch, square corner, 1-1/8" x 2-1/4"	No charge
14-050	3-3/4" Backset, deadlatch, square corner, 1-1/8" x 2-1/4"	\$15.00
43-001	5" Backset extension link, deadlatch	\$47.00
39-030 ⁷	Rabbeted latch and strike kit, 605 and 626 only	\$85.00

7. Adapts square corner latch and 2-3/4" square corner strike to 1/2" rabbeted door and frame.

13. Select strike plate **Price adjustment**

LLL	Less Strike Plate	-\$6.30
10-025	1-3/16" Lip, ANSI, no box, 1-1/14" x 4-7/8"	Standard
10-013 ⁸	1-1/8" Lip, square corner, T-strike, box, 1-1/8" - 2-3/4"	No charge
10-016	1-1/8" Lip, square corner, T-strike, deep box, fire door latch	\$22.20
K510-066	Box for ANSI strike (Must be specific)	No charge

8. 1-1/2" Lip available, must specify 1-1/2" Lip \$9.90.

14. Select door thickness **Price adjustment**

134	1-3/4"	Standard
Example 138	1-3/8" to 2-3/4", Shims included (Specify in 1/8" increments)	\$83.00

15. Select options **Price adjustment**

BAA ⁹	BAA Compliant product	\$125.00
------------------	-----------------------	----------

9. BAA compliant products must have the cover letter on page 306 included with the order. Failure to use this cover letter will result in the customer receiving non-BAA compliant product with no recourse for an RMA or refund. BAA compliant product requires a longer lead time, please contact customer service for details.

Accessories available, see pages 175–178.

Credentials available, see pages 16–20.

AD-200 STANDALONE HARDWIRED
MORTISE/MORTISE DEADBOLT

1-3. Select chassis		Price
AD-200-MS	Mortise	\$2,982.00
AD-200-MD	Mortise Deadbolt	\$3,028.00

4. Select function	(Note: Locking function capabilities are determined by users access control system.)	Price adjustment
70 ¹	Storeroom (Not available on Mortise Deadbolt)	Standard
50 ¹	Office/Classroom (Not available on Mortise Deadbolt)	\$10.00
40 ²	Privacy	\$10.00
60 ²	Apartment	\$10.00

1. Less Door Position Switch, use suffix LDP. -\$27.00
 2. Inside Push Button (IPB) only included with Mortise (MS) chassis. Mortise Deadbolt (MD) chassis comes with LED indicator only. \$10.00 charge does not apply to Mortise Deadbolt (MD) chassis.

5. Select reader	(Note: Reflects price adder to base keypad reader price of \$741.00)	Price adjustment
LLL ⁴	Less Reader	-\$741.00
KP	Keypad	Standard
MS	Magnetic Stripe (Swipe)	\$139.00
MSK	Magnetic Stripe (Swipe) + Keypad	\$229.00
MG	Magnetic Stripe (Insert)	\$160.00
MGK	Magnetic Stripe (Insert) + Keypad	\$255.00
MT	Multi-Technology Proximity and Smart Card	\$275.00
MTK	Multi-Technology + Keypad Proximity and Smart Card	\$364.00

3. For reader module accessories sold separately, see page 175.

6. Select lever ⁴		Price adjustment
LLL	Less interior and exterior levers	-\$91.30
Standard options	SPA (Sparta), RHO (Rhodes), ATH (Athens), TLR (Tubular), BRW (Broadway), BRK (Boardwalk), LAT (Latitude), LON (Longitude)	No charge

4. Tactile Warning use 8AT for Athens, 8RO for Rhodes, 8SP for Sparta and 8TR for Tubular. \$67.00 per lever. Applied to exterior lever only unless otherwise specified. Not available with 643e finish.

7. Select finish		Price adjustment
626	Satin Chrome	No charge
605	Bright Brass	\$166.00
606	Satin Brass	\$166.00
612	Satin Bronze	\$166.00
619	Satin Nickel	\$166.00
625	Bright Chrome	\$166.00
643e	Aged Bronze	\$166.00
626AM	Satin Chrome Antimicrobial	\$215.00



AD-200-MS-70-MG



KP



MGK



MS



MSK



MT/SI



MTK/SIK/FMK

AD-200 STANDALONE HARDWIRED
MORTISE/MORTISE DEADBOLT

8. Select cylinder type		Price adjustment	
		Open	Restricted
<input type="checkbox"/> ● P6	With Cylinder, Schlage - (Everest 29 S123, 6-pin KIL standard)	No charge	\$30.00
L	Less Cylinder, Schlage, Falcon, 6-pin KIL	-\$90.00	-\$90.00
<input type="checkbox"/> ● R	With Cylinder, Schlage 6-pin (Everest 29 S123 standard) FSIC	\$102.00	\$132.00
J	Less Cylinder, Schlage, 6-pin FSIC	-\$55.00	-\$55.00
<input type="checkbox"/> ● G	With Cylinder, Schlage 7-pin (Everest 29R standard) (factory master keyed only) SFIC	N/A	\$113.00
B	Less Cylinder, Schlage, Falcon, Competitive OEM's, 7-pin (SFIC)	-\$55.00	-\$55.00
L-SAR	Less Cylinder, Sargent (10L + 11L), 6-pin KIL (Only RHO, 8RO, SPA, 8SP, TLR, 8TR, ATH, 8AT lever styles)	No charge	No charge
L-CO6	Less Cylinder, Corbin, 6-pin KIL (Only RHO, 8RO, SPA, 8SP lever styles)	No charge	No charge
J-SAR	Less Cylinder, Sargent 6300, 6-pin FSIC	No charge	No charge
J-CO6	Less Cylinder, Corbin 8000, 6-pin FSIC	No charge	No charge
J-CO7	Less Cylinder, Corbin 8000-7, 7-pin FSIC, (Only RHO, 8RO, SPA, 8SP, TLR and 8TR)	No charge	No charge
J-MED	Less Cylinder, Medeco 32*0201, 6-pin FSIC (Only RHO, 8RO, SPA, 8SP lever styles)	No charge	No charge
J-YA6	Less Cylinder, Yale 1210 or Medeco 31*0100, 6-pin FSIC	No charge	No charge
J-YA7	Less Cylinder, Yale 1220, 7-pin FSIC (Only RHO, 8RO, SPA, 8SP lever styles)	No charge	No charge
L-FA7	Less Cylinder, Falcon, 7-pin, KIL (Only RHO, 8RO, SPA, 8SP lever styles)	No charge	No charge

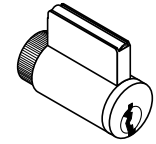
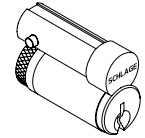
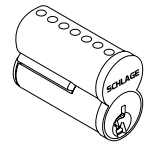
Full Cylinder
P6, L, L-SAR, L-FA7

SFIC Format
R, J, J-SAR, J-CO6, J-CO7, J-YA6

SFIC Format
B, G

- Master Keyed cylinders can be specified and will be shipped in lock packaging. For Master Keying System Summary form which should accompany the master keyed order, see page 296.
- △ For master keying, an additional charge of \$28.30 each applies. Specify line item 50-210.
- Control keys for installation/removal of interchangeable cores are not furnished and must be ordered separate. For additional assistance on Master Keying as well as restricted keyways, please contact customer service.

9. Select keying type		Price adjustment
Open keyway families: KIL or FSIC⁵		
S123	Everest 29 S (Key in Lever or FSIC)	Standard
C123	Everest C	No charge
C/CE/E/EF/F/FG/G	Classic Obverse	No charge
Restricted keyway families: KIL or FSIC^{5,6}		
29T	Everest 29 T	\$30.00
D	Everest D	\$30.00
Classic Restricted	Quad, Numbered, Reverse	\$30.00
Restricted keyway families: SFIC⁷		
29 R	Everest 29 R	No charge
B	Everest B	No charge

5. Full size key systems (Everest 29 S and T, Everest C and D, Obverse and Quad) are available in Primus and Primus XP key system and must be ordered separately. Lock should be ordered less cylinder and Primus cylinder should be a separate line.
6. Everest restricted keyways require a Letter of Authorization to be submitted with the order. See page 302 for sample Letter of Authorization.
7. Master keyed cylinders can be specified and will be shipped in lock packaging. For Master Keying System Summary form which should accompany the master keyed order, see page 296.

10. Select handing (field reversible)		Price adjustment
RH	Right handed	No charge
LH	Left handed	No charge
RHR	Right handed reverse	No charge
LHR	Left handed reverse	No charge



AD-200 STANDALONE HARDWIRED

MORTISE/MORTISE DEADBOLT

11. Select battery		Price adjustment
LLL	Less Battery Holder, batteries, and cover	-\$36.40
4B	4AA Battery kit	Standard
8B	8AA Battery kit	\$54.90

12. Select mortise lock armor front		Price adjustment
LLL	Less Armor Front	-\$23.60
09-663	1-1/4" Wide square corner, latch for MS	Standard
09-669	1-1/16" Wide square corner, Latch, options for MS	No charge
09-666	1-1/4" Wide square corner, latch x deadbolt for MD	Standard
09-672	1-1/16" Wide square corner, latch x deadbolt, options for MD	No charge

13. Select strike plate		Price adjustment
LLL	Less Strike	-\$18.40
10-072	1-1/4" x 4-7/8" Square corner + box; 1-3/16" lip length	Standard
10-072xx	1-1/4" x 4-7/8" Square corner + box; specify lip length (xx) as 1" or 1-1/2"	No charge
10-072xx	1-1/4" x 4-7/8" Square corner + box; specify lip length (xx) as 1-3/4"	\$45.00
10-075 ⁸	1/2" Rabbeted	\$155.00
37-015	Strike frame reinforcer, specify 37-015	No charge

8. For 1-3/4" thick doors, use wide armor front. For over 1-3/4" thick door extended equally (EE) use 1-1/4" wide armor front.
⁸ Extended lead time, consult customer service.

14. Select door thickness		Price adjustment
134	1-3/4"	Standard
Example 138	1-3/8" to 2-3/4", Shims included (Specify in 1/8" increments)	\$83.00

15. Select options		Price adjustment
BAA ⁹	BAA Compliant product	\$125.00

9. BAA compliant products must have the cover letter on page 306 included with the order. Failure to use this cover letter will result in the customer receiving non-BAA compliant product with no recourse for an RMA or refund. BAA compliant product requires a longer lead time, please contact customer service for details.

Accessories available, see pages 175–178.

Credentials available, see pages 16–20.

AD-200 STANDALONE HARDWIRED
EXIT TRIM

1-3. Select chassis/trim type (Note: See page 142 for exit device compatibility.) **Price**

AD-200-993R	Exit Rim / Concealed Vertical Rod (Metal Door) / Concealed Vertical Cable (Metal Door)	\$3,094.00
AD-200-993S	Exit Surface Vertical Rod	\$3,130.00
AD-200-993M	Exit Mortise Lock	\$3,130.00



AD-200-993-70-MTK

4. Select function (Note: Locking function capabilities are determined by users access control system.) **Price adjustment**

70 ¹	Storeroom (Not available on Mortise Deadbolt)	Standard
50 ^{1,2}	Office/Classroom (Not available on Mortise Deadbolt)	\$10.00
40 ²	Privacy	\$10.00
60 ²	Apartment	\$10.00

1. Less Door Position Switch, use suffix LDP. -\$27.00
2. Confirm these functions are supported by your access control system provider. RX-LC switch is included when ordered in 40, 50 or 60 function. Please specify if Von Duprin Exit or Falcon Exit is being used.



KP

5. Select reader (Note: Reflects price adder to base keypad reader price of \$741.00) **Price adjustment**

LLL ³	Less Reader	-\$741.00
KP	Keypad	No charge
MS	Magnetic Stripe (Swipe)	\$139.00
MSK	Magnetic Stripe (Swipe) + Keypad	\$229.00
MG	Magnetic Stripe (Insert)	\$160.00
MGK	Magnetic Stripe (Insert) + Keypad	\$255.00
MT	Multi-Technology Proximity and Smart Card	\$275.00
MTK	Multi-Technology + Keypad Proximity and Smart Card	\$364.00



MG



MS

3. For reader module accessories sold separately, see page 175.

6. Select lever⁴ **Price adjustment**

LLL	Less interior and exterior levers	-\$31.60
Standard options	SPA (Sparta), RHO (Rhodes), ATH (Athens), TLR (Tubular), BRW (Broadway), BRK (Boardwalk), LAT (Latitude), LON (Longitude)	No charge



MSK

4. Tactile Warning use 8AT for Athens, 8RO for Rhodes, 8SP for Sparta and 8TR for Tubular. \$67.00 per lever. Applied to exterior lever only unless otherwise specified. Not available with 643e finish.

7. Select finish **Price adjustment**

626	Satin Chrome	No charge
605	Bright Brass	\$166.00
606	Satin Brass	\$166.00
612	Satin Bronze	\$166.00
619	Satin Nickel	\$166.00
625	Bright Chrome	\$166.00
643e	Aged Bronze	\$166.00
626AM	Satin Chrome Antimicrobial	\$215.00



MT/SI



MTK/SIK/FMK

AD-200 STANDALONE HARDWIRED

EXIT TRIM

8. Select cylinder type		Price adjustment	
		Open	Restricted
<input type="checkbox"/> ● P6	With Cylinder, Schlage - (Everest 29 S123, 6-pin KIL standard)	No charge	\$30.00
L	Less Cylinder, Schlage, Falcon, 6-pin KIL	-\$90.00	-\$90.00
<input type="checkbox"/> ● R	With Cylinder, Schlage 6-pin (Everest 29 S123 standard) FSIC	\$102.00	\$132.00
J	Less Cylinder, Schlage, 6-pin FSIC	-\$55.00	-\$55.00
<input type="checkbox"/> ● G	With Cylinder, Schlage 7-pin (Everest 29R standard) (factory master keyed only) SFIC	N/A	\$113.00
B	Less Cylinder, Schlage, Falcon, Competitive OEM's, 7-pin (SFIC)	-\$55.00	-\$55.00
L-SAR	Less Cylinder, Sargent (10L + 11L), 6-pin KIL (Only RHO, 8RO, SPA, 8SP, TLR, 8TR, ATH, 8AT lever styles)	No charge	No charge
L-CO6	Less Cylinder, Corbin, 6-pin KIL (Only RHO, 8RO, SPA, 8SP lever styles)	No charge	No charge
J-SAR	Less Cylinder, Sargent 6300, 6-pin FSIC	No charge	No charge
J-CO6	Less Cylinder, Corbin 8000, 6-pin FSIC	No charge	No charge
J-CO7	Less Cylinder, Corbin 8000-7, 7-pin FSIC, (Only RHO, 8RO, SPA, 8SP, TLR and 8TR)	No charge	No charge
J-MED	Less Cylinder, Medeco 32*0201, 6-pin FSIC (Only RHO, 8RO, SPA, 8SP lever styles)	No charge	No charge
J-YA6	Less Cylinder, Yale 1210 or Medeco 31*0100, 6-pin FSIC	No charge	No charge
J-YA7	Less Cylinder, Yale 1220, 7-pin FSIC (Only RHO, 8RO, SPA, 8SP lever styles)	No charge	No charge
L-FA7	Less Cylinder, Falcon, 7-pin, KIL (Only RHO, 8RO, SPA, 8SP lever styles)	No charge	No charge

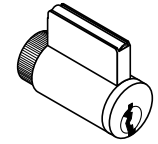
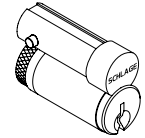
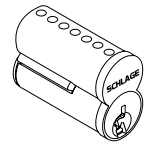
Full Cylinder
P6, L, L-SAR, L-FA7

SFIC Format
R, J, J-SAR, J-CO6, J-CO7, J-YA6

SFIC Format
B, G

- Master Keyed cylinders can be specified and will be shipped in lock packaging. For Master Keying System Summary form which should accompany the master keyed order, see page 296.
- △ For master keying, an additional charge of \$28.30 each applies. Specify line item 50-210.
- Control keys for installation/removal of interchangeable cores are not furnished and must be ordered separate. For additional assistance on Master Keying as well as restricted keyways, please contact customer service.

9. Select keying type		Price adjustment
Open keyway families: KIL or FSIC⁵		
S123	Everest 29 S (Key in Lever or FSIC)	Standard
C123	Everest C	No charge
C/CE/E/EF/F/FG/G	Classic Obverse	No charge
Restricted keyway families: KIL or FSIC^{5,6}		
29T	Everest 29 T	\$30.00
D	Everest D	\$30.00
Classic Restricted	Quad, Numbered, Reverse	\$30.00
Restricted keyway families: SFIC⁷		
29 R	Everest 29 R	No charge
B	Everest B	No charge

5. Full Size key systems (Everest 29 S and T, Everest C and D, Obverse and Quad) are available in Primus and Primus XP key system and must be ordered separately. Lock should be ordered less cylinder and Primus cylinder should be a separate line.
6. Everest Restricted Keyways require a Letter of Authorization to be submitted with the order. See page 302 for sample Letter of Authorization.
7. Master Keyed cylinders can be specified and will be shipped in lock packaging. For Master Keying System Summary form which should accompany the master keyed order, see page 296.

10. Select handing (field reversible)		Price adjustment
RHR	Right handed reverse	No charge
LHR	Left handed reverse	No charge



AD-200 STANDALONE HARDWIRED

EXIT TRIM

11. Select battery **Price adjustment**

LLL	Less Battery Holder, batteries, and cover	-\$36.40
4B	4AA Battery kit	Standard
8B	8AA Battery kit	\$54.90

12. – 13. No selection required**14. Select door thickness** **Price adjustment**

134	1-3/4"	Standard
Example 200	1-3/4" to 2-3/4", (Specify in 1/8" increments)	\$83.00

15. Select options **Price adjustment**

BAA ⁸	BAA Compliant product	\$125.00
------------------	-----------------------	----------

8. BAA compliant products must have the cover letter on page 306 included with the order. Failure to use this cover letter will result in the customer receiving non-BAA compliant product with no recourse for an RMA or refund. BAA compliant product requires a longer lead time, please contact customer service for details.

Accessories available, see pages 175–178. Accessories include Decorative plates, SUS A-KIT, etc.

Credentials available, see pages 16–20.

AD Series Non-Functioning "Dummy" Exit trim now available. Please see pages 173–174 for details.

AD Series Exit trim

The AD993DT Non-Functioning Dummy Trim comes with a universal mounting plate and is compatible with the following exit devices:

- **Von Duprin 98/99 and 98/99XP**
 - Rim, Concealed Vertical Rod (metal door only), Concealed Vertical Cable (metal door only), Surface Vertical Rod, Mortise.
 - Low current Request-to-Exit Switch optional for future network migration or if ordered as a 40, 50 or 60 function.
- **Von Duprin 22/22F**
 - Rim, Surface Vertical Rod
- **Falcon 25**
 - Rim Low current Request-to-Exit switch optional for future network migration or included if ordered as a 40, 50 or 60 function.
- **Sargent 80 Series** (Narrow design and reversible rim exits not compatible) – Rim
- **Corbin Russwin 5000 Series** – Rim
- **Yale 7000** – Rim
- **Dorma 9300** – Rim
- **Precision 21** – Rim (2100 converts to 21 with Precision's BP21 Kit)

AD-201 STANDALONE HARDWIRED CYLINDRICAL (FIPS COMPLIANT)

1-4. Select chassis/function (Note: Locking function capabilities are determined by users access control system.)		Price
AD-201-CY-70 ¹	Storeroom	\$2,596.00
AD-201-CY-50 ¹	Office/Classroom	\$2,606.00
AD-201-CY-40	Privacy	\$2,606.00
AD-201-CY-60	Apartment	\$2,606.00

1. Less Door Position Switch, use suffix LDP. -\$27.00

5. Select reader		Price adjustment
FMK	FIPS 201-2 Multi-Technology + Keypad Proximity and Smart Card (PIV and PIV-I Card)	\$664.00

6. Select lever ²		Price adjustment
LLL	Less each lever	-\$65.20
Standard options	SPA (Sparta), RHO (Rhodes), ATH (Athens), TLR (Tubular), BRW (Broadway), BRK (Boardwalk), LAT (Latitude), LON (Longitude)	No charge

2. Tactile Warning use 8AT for Athens, 8RO for Rhodes, 8SP for Sparta and 8TR for Tubular. \$67.00 per lever. Applied to exterior lever only unless otherwise specified. Not available with 643e finish.

7. Select finish		Price adjustment
626	Satin Chrome	No charge
605	Bright Brass	\$166.00
606	Satin Brass	\$166.00
612	Satin Bronze	\$166.00
619	Satin Nickel	\$166.00
625	Bright Chrome	\$166.00
643e	Aged Bronze	\$166.00
626AM	Satin Chrome Antimicrobial	\$215.00

8. Select cylinder type		Price adjustment	
		Open	Restricted
<input type="checkbox"/> ● P6	With Cylinder, Schlage - (Everest 29 S123, 6-pin KIL standard)	No charge	\$30.00
L	Less Cylinder, Schlage, Falcon, 6-pin KIL	-\$90.00	-\$90.00
<input type="checkbox"/> ● R	With Cylinder, Schlage 6-pin (Everest 29 S123 standard) FSIC	\$102.00	\$132.00
J	Less Cylinder, Schlage, 6-pin FSIC	-\$55.00	-\$55.00
<input type="checkbox"/> ● G	With Cylinder, Schlage 7-pin (Everest 29R standard) (factory master keyed only) SFIC	N/A	\$113.00
B	Less Cylinder, Schlage, Falcon, Competitive OEM's, 7-pin (SFIC)	-\$55.00	-\$55.00
L-SAR	Less Cylinder, Sargent (10L + 11L), 6-pin KIL (Only RHO, 8RO, SPA, 8SP, TLR, 8TR, ATH, 8AT lever styles)	No charge	No charge
L-CO6	Less Cylinder, Corbin, 6-pin KIL (Only RHO, 8RO, SPA, 8SP lever styles)	No charge	No charge
J-SAR	Less Cylinder, Sargent 6300, 6-pin FSIC	No charge	No charge
J-CO6	Less Cylinder, Corbin 8000, 6-pin FSIC	No charge	No charge
J-CO7	Less Cylinder, Corbin 8000-7, 7-pin FSIC, (Only RHO, 8RO, SPA, 8SP, TLR and 8TR)	No charge	No charge
J-MED	Less Cylinder, Medeco 32*0201, 6-pin FSIC (Only RHO, 8RO, SPA, 8SP lever styles)	No charge	No charge
J-YA6	Less Cylinder, Yale 1210 or Medeco 31*0100, 6-pin FSIC	No charge	No charge
J-YA7	Less Cylinder, Yale 1220, 7-pin FSIC (Only RHO, 8RO, SPA, 8SP lever styles)	No charge	No charge
L-FA7	Less Cylinder, Falcon, 7-pin, KIL (Only RHO, 8RO, SPA, 8SP lever styles)	No charge	No charge

● Master Keyed cylinders can be specified and will be shipped in lock packaging. For Master Keying System Summary form which should accompany the master keyed order, see page 296.

△ For master keying, an additional charge of \$28.30 each applies. Specify line item 50-210.

Control keys for installation/removal of interchangeable cores are not furnished and must be ordered separate.

For additional assistance on Master Keying as well as restricted keyways, please contact customer service.



AD-201-CY-70-FMK

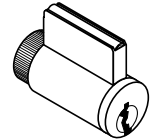

Full Cylinder
P6, L, L-SAR, L-FA7

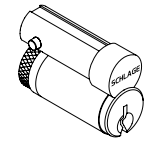

FSIC Format
R, J, J-SAR, J-CO6,
J-CO7, J-YA6

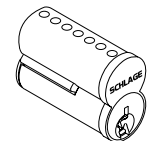

SFIC Format
B, G



AD-201 STANDALONE HARDWIRED CYLINDRICAL (FIPS COMPLIANT)

9. Select keying type		Price adjustment
Open keyway families: KIL or FSIC³		
S123	Everest 29 S (Key in Lever or FSIC)	Standard
C123	Everest C	No charge
C/CE/E/EF/F/FG/G	Classic Obverse	No charge
Restricted keyway families: KIL or FSIC^{3,4}		
29T	Everest 29 T	\$30.00
D	Everest D	\$30.00
Classic Restricted	Quad, Numbered, Reverse	\$30.00
Restricted keyway families: SFIC⁵		
29R	Everest 29 R	No charge
B	Everest B	No charge

3. Full size key systems (Everest 29 S and T, Everest C and D, Obverse and Quad) are available in Primus and Primus XP key system and must be ordered separately. Lock should be ordered less cylinder and Primus cylinder should be a separate line.
4. Everest restricted keyways require a Letter of Authorization to be submitted with the order. See page 302 for sample Letter of Authorization.
5. Master keyed cylinders can be specified and will be shipped in lock packaging. For Master Keying System Summary form which should accompany the master keyed order, see page 296.

10. Select handing (field reversible)		Price adjustment
RH	Right handed	No charge
LH	Left handed	No charge
RHR	Right handed reverse	No charge
LHR	Left handed reverse	No charge

11. Select battery		Price adjustment
LLL	Less Battery Holder, batteries, and cover	-\$36.40
4B	4AA Battery kit	Standard
8B	8AA Battery kit	\$54.90

12. Select backset and latch bolt		Price adjustment
LLL	Less Latch	-\$48.00
13-247	2-3/4" Backset, deadlatch, square corner, 1-1/8" x 2-1/4"	Standard
14-049	2-3/4" Backset, deadlatch anti-friction fire door latch, square corner, 1-1/8" x 2-1/4", 3/4" throw	\$254.00
14-051	2-3/8" Backset, deadlatch, square corner, 1-1/8" x 2-1/4"	No charge
14-050	3-3/4" Backset, deadlatch, square corner, 1-1/8" x 2-1/4"	\$15.00
43-001	5" Backset extension link, deadlatch	\$47.00
39-030 ⁶	Rabbeted latch and strike kit, 605 and 626 only	\$85.00

6. Adapts square corner latch and 2-3/4" square corner strike to 1/2" rabbeted door and frame.

13. Select strike plate		Price adjustment
LLL	Less Strike Plate	-\$6.30
10-025	1-3/16" Lip, ANSI, no box, 1-1/14" x 4-7/8"	Standard
10-0137	1-1/8" Lip, square corner, T-strike, box, 1-1/8" - 2-3/4"	No charge
10-016	1-1/8" Lip, square corner, T-strike, deep box, fire door latch	No charge
K510-066	Box for ANSI strike (Must be specific)	No charge

7. 1-1/2" Lip available, must specify 1-1/2" Lip \$9.90.

14. Select door thickness		Price adjustment
134	1-3/4"	Standard
Example 138	1-3/8" to 2-3/4", shims included (specify in 1/8" increments)	\$83.00

The AD-200 lock can be field upgraded to a FIPS compliant solution simply by adding the FMK reader (sold separately) and by using the most current firmware revision.

Standard accessories available, see pages 175-178.

AD-201 STANDALONE HARDWIRED

MORTISE/MORTISE DEADBOLT (FIPS COMPLIANT)



1-3. Select chassis		Price
AD-201-MS	Mortise	\$2,982.00
AD-201-MD	Mortise Deadbolt	\$3,028.00

4. Select function	(Note: Locking function capabilities are determined by users access control system.)	Price adjustment
70 ¹	Storeroom (Not available on Mortise Deadbolt)	Standard
50 ¹	Office/Classroom (Not available on Mortise Deadbolt)	\$10.00
40	Privacy	\$10.00
60	Apartment	\$10.00

1. Less Door Position Switch, use suffix LDP. -\$27.00

5. Select reader		Price adjustment
FMK	FIPS 201-2 Multi-Technology + Keypad Proximity and Smart Card (PIV and PIV-I Card)	\$664.00

6. Select lever ²		Price adjustment
LLL	Less interior and exterior levers	-\$76.70
Standard options	SPA (Sparta), RHO (Rhodes), ATH (Athens), TLR (Tubular), BRW (Broadway), BRK (Boardwalk), LAT (Latitude), LON (Longitude)	No charge

2. Tactile Warning use 8AT for Athens, 8RO for Rhodes, 8SP for Sparta and 8TR for Tubular. \$67.00 per lever. Applied to exterior lever only unless otherwise specified. Not available with 643e finish.

7. Select finish		Price adjustment
626	Satin Chrome	No charge
605	Bright Brass	\$166.00
606	Satin Brass	\$166.00
612	Satin Bronze	\$166.00
619	Satin Nickel	\$166.00
625	Bright Chrome	\$166.00
643e	Aged Bronze	\$166.00
626AM	Satin Chrome Antimicrobial	\$215.00

8. Select cylinder type		Price adjustment			
		Open	Restricted		
<input checked="" type="checkbox"/>	P6	With Cylinder, Schlage - (Everest 29 S123, 6-pin KIL standard)	No charge	\$30.00	
	L	Less Cylinder, Schlage, Falcon, 6-pin KIL	-\$90.00	-\$90.00	
<input type="checkbox"/>	<input checked="" type="checkbox"/>	R	With Cylinder, Schlage 6-pin (Everest 29 S123 standard) FSIC	\$102.00	\$132.00
	J	Less Cylinder, Schlage, 6-pin FSIC	-\$55.00	-\$55.00	
<input type="checkbox"/>	<input checked="" type="checkbox"/>	G	With Cylinder, Schlage 7-pin (Everest 29R standard) (factory master keyed only) SFIC	N/A	\$113.00
	B	Less Cylinder, Schlage, Falcon, Competitive OEM's, 7-pin (SFIC)	-\$55.00	-\$55.00	
	L-SAR	Less Cylinder, Sargent (10L + 11L), 6-pin KIL (Only RHO, 8RO, SPA, 8SP, TLR, 8TR, ATH, 8AT lever styles)	No charge	No charge	
	L-CO6	Less Cylinder, Corbin, 6-pin KIL (Only RHO, 8RO, SPA, 8SP lever styles)	No charge	No charge	
	J-SAR	Less Cylinder, Sargent 6300, 6-pin FSIC	No charge	No charge	
	J-CO6	Less Cylinder, Corbin 8000, 6-pin FSIC	No charge	No charge	
	J-CO7	Less Cylinder, Corbin 8000-7, 7-pin FSIC, (Only RHO, 8RO, SPA, 8SP, TLR and 8TR)	No charge	No charge	
	J-MED	Less Cylinder, Medeco 32*0201, 6-pin FSIC (Only RHO, 8RO, SPA, 8SP lever styles)	No charge	No charge	
	J-YA6	Less Cylinder, Yale 1210 or Medeco 31*0100, 6-pin FSIC	No charge	No charge	
	J-YA7	Less Cylinder, Yale 1220, 7-pin FSIC (Only RHO, 8RO, SPA, 8SP lever styles)	No charge	No charge	
	L-FA7	Less Cylinder, Falcon, 7-pin, KIL (Only RHO, 8RO, SPA, 8SP lever styles)	No charge	No charge	

● Master Keyed cylinders can be specified and will be shipped in lock packaging. For Master Keying System Summary form which should accompany the master keyed order, see page 296.

△ For master keying, an additional charge of \$28.30 each applies. Specify line item 50-210.

□ Control keys for installation/removal of interchangeable cores are not furnished and must be ordered separate.

For additional assistance on Master Keying as well as restricted keyways, please contact customer service.

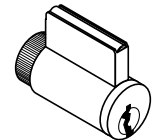
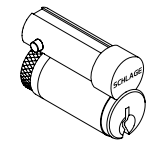
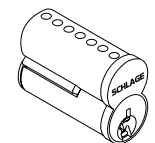

AD-201-MS-70-FMK

 Full Cylinder
P6, L, L-SAR, L-FA7

 FSIC Format
R, J, J-SAR, J-CO6,
J-CO7, J-YA6

 SFIC Format
B, G



AD-201 STANDALONE HARDWIRED

MORTISE/MORTISE DEADBOLT (FIPS COMPLIANT)

9. Select keying type **Price adjustment**

Open keyway families: KIL or FSIC ⁴		
S123	Everest 29 S (Key in Lever or FSIC)	Standard
C123	Everest C	No charge
C/CE/E/EF/F/FG/G	Classic Obverse	No charge
Restricted keyway families: KIL or FSIC ^{4,5}		
29T	Everest 29 T	\$30.00
D	Everest D	\$30.00
Classic Restricted	Quad, Numbered, Reverse	\$30.00
Restricted keyway families: SFIC ⁶		
29R	Everest 29 R	No charge
B	Everest B	No charge

- Full size key systems (Everest 29 S and T, Everest C and D, Obverse and Quad) are available in Primus and Primus XP key system and must be ordered separately. Lock should be ordered less cylinder and Primus cylinder should be a separate line.
- Everest restricted keyways require a Letter of Authorization to be submitted with the order. See page 302 for sample Letter of Authorization.
- Master keyed cylinders can be specified and will be shipped in lock packaging. For Master Keying System Summary form which should accompany the master keyed order, see page 296.

10. Select handing (field reversible) **Price adjustment**

RH	Right handed	No charge
LH	Left handed	No charge
RHR	Right handed reverse	No charge
LHR	Left handed reverse	No charge

11. Select battery **Price adjustment**

LLL	Less Battery Holder, batteries, and cover	-\$36.40
4B	4AA Battery kit	Standard
8B	8AA Battery kit	\$54.90

12. Select mortise lock armor front **Price adjustment**

LLL	Less Armor Front	-\$23.60
09-663	1-1/4" Wide square corner, latch for MS	Standard
09-669	1-1/16" Wide square corner, Latch, options for MS	No charge
09-666	1-1/4" Wide square corner, latch x deadbolt for MD	Standard
09-672	1-1/16" Wide square corner, latch x deadbolt, options for MD	No charge

13. Select strike plate **Price adjustment**

LLL	Less Strike	-\$18.40
10-072	1-1/4" x 4-7/8" Square corner + box; 1-3/16" lip length	Standard
10-072xx	1-1/4" x 4-7/8" Square corner + box; specify lip length (xx) as 1" or 1-1/2"	No charge
10-072xx	1-1/4" x 4-7/8" Square corner + box; specify lip length (xx) as 1-3/4"	\$45.00
10-075 ⁶	1/2" Rabbeted	\$155.00
37-015	Strike frame reinforcer, specify 37-015	No charge

- For 1-3/4" thick doors, use wide armor front. For over 1-3/4" thick door extended equally (EE) use 1-1/4" wide armor front.
- Extended lead time, consult customer service.

14. Select door thickness **Price adjustment**

134	1-3/4"	Standard
Example 138	1-3/8" to 2-3/4", Shims included (Specify in 1/8" increments)	\$83.00

The AD-200 lock can be field upgraded to a FIPS compliant solution simply by adding the FMK reader (sold separately) and by using the most current firmware revision.

Standard accessories available, see pages 175–178.

AD-201 STANDALONE HARDWIRED EXIT TRIM (FIPS COMPLIANT)

AD-201-993R-70-FMK

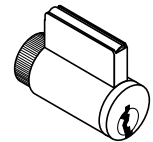
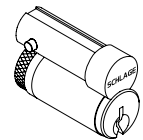
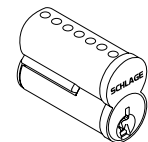
 Full Cylinder
P6, L, L-SAR, L-FA7

 FSIC Format
R, J, J-SAR, J-CO6,
J-CO7, J-YA6

 SFIC Format
B, G

1-3. Select chassis/exit trim type (Note: See page 142 for exit device compatibility.)		Price
AD-201-993R	Exit Rim / Concealed Vertical Rod (Metal Door) / Concealed Vertical Cable (Metal Door)	\$3,094.00
AD-201-993S	Exit Surface Vertical Rod	\$3,130.00
AD-201-993M	Exit Mortise Lock	\$3,130.00

4. Select function (Note: Locking function capabilities are determined by users access control system.)		Price adjustment
70 ¹	Storeroom	Standard
50 ¹	Office/Classroom	\$10.00
40	Privacy	\$10.00
60	Apartment	\$10.00

1. Less Door Position Switch, use suffix LDP. -\$27.00

5. Select reader		Price adjustment
FMK	FIPS 201-2 Multi-Technology + Keypad Proximity and Smart Card (PIV and PIV-I Card)	\$664.00

6. Select lever ²		Price adjustment
LLL	Less interior and exterior levers	-\$32.60
Standard options	SPA (Sparta), RHO (Rhodes), ATH (Athens), TLR (Tubular), BRW (Broadway), BRK (Boardwalk), LAT (Latitude), LON (Longitude)	No charge

2. Tactile Warning use 8AT for Athens, 8RO for Rhodes, 8SP for Sparta and 8TR for Tubular. \$67.00 per lever. Applied to exterior lever unless otherwise specified. Not available with 643e finish.

7. Select finish		Price adjustment
626	Satin Chrome	No charge
605	Bright Brass	\$166.00
606	Satin Brass	\$166.00
612	Satin Bronze	\$166.00
619	Satin Nickel	\$166.00
625	Bright Chrome	\$166.00
643e	Aged Bronze	\$166.00
626AM	Satin Chrome Antimicrobial	\$215.00

8. Select cylinder type		Price adjustment	
		Open	Restricted
<input type="checkbox"/> ● P6	With Cylinder, Schlage - (Everest 29 S123, 6-pin KIL standard)	No charge	\$30.00
L	Less Cylinder, Schlage, Falcon, 6-pin KIL	-\$90.00	-\$90.00
<input type="checkbox"/> ● R	With Cylinder, Schlage 6-pin (Everest 29 S123 standard) FSIC	\$102.00	\$132.00
J	Less Cylinder, Schlage, 6-pin FSIC	-\$55.00	-\$55.00
<input type="checkbox"/> ● G	With Cylinder, Schlage 7-pin (Everest 29R standard) (factory master keyed only) SFIC	N/A	\$113.00
B	Less Cylinder, Schlage, Falcon, Competitive OEM's, 7-pin (SFIC)	-\$55.00	-\$55.00
L-SAR	Less Cylinder, Sargent (10L + 11L), 6-pin KIL (Only RHO, 8RO, SPA, 8SP, TLR, 8TR, ATH, 8AT lever styles)	No charge	No charge
L-CO6	Less Cylinder, Corbin, 6-pin KIL (Only RHO, 8RO, SPA, 8SP lever styles)	No charge	No charge
J-SAR	Less Cylinder, Sargent 6300, 6-pin FSIC	No charge	No charge
J-CO6	Less Cylinder, Corbin 8000, 6-pin FSIC	No charge	No charge
J-CO7	Less Cylinder, Corbin 8000-7, 7-pin FSIC, (Only RHO, 8RO, SPA, 8SP, TLR and 8TR)	No charge	No charge
J-MED	Less Cylinder, Medeco 32*0201, 6-pin FSIC (Only RHO, 8RO, SPA, 8SP lever styles)	No charge	No charge
J-YA6	Less Cylinder, Yale 1210 or Medeco 31*0100, 6-pin FSIC	No charge	No charge
J-YA7	Less Cylinder, Yale 1220, 7-pin FSIC (Only RHO, 8RO, SPA, 8SP lever styles)	No charge	No charge
L-FA7	Less Cylinder, Falcon, 7-pin, KIL (Only RHO, 8RO, SPA, 8SP lever styles)	No charge	No charge

● Master Keyed cylinders can be specified and will be shipped in lock packaging. For Master Keying System Summary form which should accompany the master keyed order, see page 296.

△ For master keying, an additional charge of \$28.30 each applies. Specify line item 50-210.

 Control keys for installation/removal of interchangeable cores are not furnished and must be ordered separate.

For additional assistance on Master Keying as well as restricted keyways, please contact customer service.



AD-201 STANDALONE HARDWIRED EXIT TRIM (FIPS COMPLIANT)

9. Select keying type		Price adjustment
Open keyway families: KIL or FSIC³		
S123	Everest 29 S (Key in Lever or FSIC)	Standard
C123	Everest C	No charge
C/CE/E/EF/F/FG/G	Classic Obverse	No charge
Restricted keyway families: KIL or FSIC^{3,4}		
29T	Everest 29 T	\$30.00
D	Everest D	\$30.00
Classic Restricted	Quad, Numbered, Reverse	\$30.00
Restricted keyway families: SFIC⁵		
29 R	Everest 29 R	No charge
B	Everest B	No charge

3. Full Size key systems (Everest 29 S and T, Everest C and D, Obverse and Quad) are available in Primus and Primus XP key system and must be ordered separately. Lock should be ordered less cylinder and Primus cylinder should be a separate line.
4. Everest Restricted Keyways require a Letter of Authorization to be submitted with the order. See page 302 for sample Letter of Authorization.
5. Master Keyed cylinders can be specified and will be shipped in lock packaging. For Master Keying System Summary form which should accompany the master keyed order, see page 296.

10. Select handing (field reversible)		Price adjustment
RHR	Right handed reverse	No charge
LHR	Left handed reverse	No charge

11. Select battery		Price adjustment
LLL	Less Battery Holder, batteries, and cover	-\$36.40
4B	4AA Battery kit	Standard
8B	8AA Battery kit	\$54.90

12. – 13. No selection required

14. Select door thickness		Price adjustment
134	1-3/4"	Standard
Example 200	1-3/4" to 2-3/4", (Specify in 1/8" increments)	\$83.00

Standard accessories available, see pages 175–178.

The AD-200 lock can be field upgraded to a FIPS compliant solution simply by adding the FMK reader (sold separately) and by using the most current firmware revision.

AD Series Exit trim

The AD993DT Non-Functioning Dummy Trim comes with a universal mounting plate and is compatible with the following exit devices:

- **Von Duprin 98/99 and 98/99XP**
 - Rim, Concealed Vertical Rod (metal door only), Concealed Vertical Cable (metal door only), Surface Vertical Rod, Mortise. Low current Request-to-Exit Switch optional for future network migration.
- **Von Duprin 22/22F**
 - Rim, Surface Vertical Rod
- **Falcon 25 – Rim**
- **Sargent 80 Series** (Narrow design and reversible rim exits not compatible) – Rim
- **Corbin Russwin 5000 Series** – Rim
- **Yale 7000** – Rim
- **Dorma 9300** – Rim
- **Precision 21** – Rim (2100 converts to 21 with Precision's BP21 Kit)

AD-250 STANDALONE RIGHTS ON CARD
CYLINDRICAL

1-4. Select chassis/function (Note: Locking function capabilities are determined by users access control system.) **Price**

AD-250-CY-70 ¹	Storeroom	\$2,832.00
AD-250-CY-50 ¹	Office/Classroom	\$2,842.00
AD-250-CY-40	Privacy	\$2,842.00
AD-250-CY-60	Apartment	\$2,842.00

1. Less Door Position Switch, use suffix LDP. -\$27.00

5. Select reader (Note: Reflects price adder to base magnetic swipe reader price of \$923.00) **Price adjustment**

LLL ²	Less Reader	-\$923.00
MS	Magnetic Stripe (Swipe)	No charge
MSK	Magnetic Stripe (Swipe) + Keypad	\$94.00
MG	Magnetic Stripe (Insert)	\$24.00
MGK	Magnetic Stripe (Insert) + Keypad	\$118.00

2. For reader module accessories sold separately, see page 175.

6. Select lever³ **Price adjustment**

LLL	Less interior and exterior levers	-\$65.20
Standard options	SPA (Sparta), RHO (Rhodes), ATH (Athens), TLR (Tubular), BRW (Broadway), BRK (Boardwalk), LAT (Latitude), LON (Longitude)	No charge

3. Tactile Warning use 8AT for Athens, 8RO for Rhodes, 8SP for Sparta and 8TR for Tubular. \$67.00 per lever. Applied to exterior lever only unless otherwise specified. Not available with 643e finish.

7. Select finish **Price adjustment**

626	Satin Chrome	No charge
605	Bright Brass	\$166.00
606	Satin Brass	\$166.00
612	Satin Bronze (00C rose not available in 612 finish)	\$166.00
619	Satin Nickel	\$166.00
625	Bright Chrome	\$166.00
643e	Aged Bronze	\$166.00
626AM	Satin Chrome Antimicrobial	\$215.00

8. Select cylinder type **Price adjustment**

		Open	Restricted
△ ● P6	With Cylinder, Schlage - (Everest 29 S123, 6-pin KIL standard)	No charge	\$30.00
L	Less Cylinder, Schlage, Falcon, 6-pin KIL	-\$90.00	-\$90.00
□ ● R	With Cylinder, Schlage 6-pin (Everest 29 S123 standard) FSIC	\$102.00	\$132.00
J	Less Cylinder, Schlage, 6-pin FSIC	-\$55.00	-\$55.00
□ ● G	With Cylinder, Schlage 7-pin (Everest 29R standard) (factory master keyed only) SFIC	N/A	\$113.00
B	Less Cylinder, Schlage, Falcon, Competitive OEM's, 7-pin (SFIC)	-\$55.00	-\$55.00
L-SAR	Less Cylinder, Sargent (10L + 11L), 6-pin KIL (Only RHO, 8RO, SPA, 8SP, TLR, 8TR, ATH, 8AT lever styles)	No charge	No charge
L-CO6	Less Cylinder, Corbin, 6-pin KIL (Only RHO, 8RO, SPA, 8SP lever styles)	No charge	No charge
J-SAR	Less Cylinder, Sargent 6300, 6-pin FSIC	No charge	No charge
J-CO6	Less Cylinder, Corbin 8000, 6-pin FSIC	No charge	No charge
J-CO7	Less Cylinder, Corbin 8000-7, 7-pin FSIC, (Only RHO, 8RO, SPA, 8SP, TLR and 8TR)	No charge	No charge
J-MED	Less Cylinder, Medeco 32*0201, 6-pin FSIC (Only RHO, 8RO, SPA, 8SP lever styles)	No charge	No charge
J-YA6	Less Cylinder, Yale 1210 or Medeco 31*0100, 6-pin FSIC	No charge	No charge
J-YA7	Less Cylinder, Yale 1220, 7-pin FSIC (Only RHO, 8RO, SPA, 8SP lever styles)	No charge	No charge
L-FA7	Less Cylinder, Falcon, 7-pin, KIL (Only RHO, 8RO, SPA, 8SP lever styles)	No charge	No charge

● Master Keyed cylinders can be specified and will be shipped in lock packaging. For Master Keying System Summary form which should accompany the master keyed order, see page 296.

△ For master keying, an additional charge of \$28.30 each applies. Specify line item 50-210.

□ Control keys for installation/removal of interchangeable cores are not furnished and must be ordered separate.

For additional assistance on Master Keying as well as restricted keyways, please contact customer service.



AD-250-CY-70-MG



MGK



MS

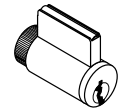
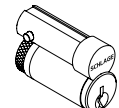
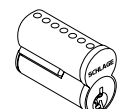

MSK

 Full Cylinder
P6, L, L-SAR, L-FA7

 FSIC Format
R, J, J-SAR, J-CO6,
J-CO7, J-YA6

 SFIC Format
B, G



AD-250 STANDALONE RIGHTS ON CARD

CYLINDRICAL

9. Select keying type **Price adjustment**

Open keyway families: KIL or FSIC ⁴		
S123	Everest 29 S (Key in Lever or FSIC)	Standard
C123	Everest C	No charge
C/CE/E/EF/F/FG/G	Classic Obverse	No charge
Restricted keyway families: KIL or FSIC ^{4,5}		
29T	Everest 29 T	\$30.00
D	Everest D	\$30.00
Classic Restricted	Quad, Numbered, Reverse	\$30.00
Restricted keyway families: SFIC ⁶		
29 R	Everest 29 R	No charge
B	Everest B	No charge

4. Full Size key systems (Everest 29 S and T, Everest C and D, Obverse and Quad) are available in Primus and Primus XP key system and must be ordered separately. Lock should be ordered less cylinder and Primus cylinder should be a separate line.
5. Everest Restricted Keyways require a Letter of Authorization to be submitted with the order. See page 302 for sample Letter of Authorization.
6. Master Keyed cylinders can be specified and will be shipped in lock packaging. For Master Keying System Summary form which should accompany the master keyed order, see page 296.

10. Select handing (field reversible) **Price adjustment**

RH	Right handed	No charge
LH	Left handed	No charge
RHR	Right handed reverse	No charge
LHR	Left handed reverse	No charge

11. Select battery **Price adjustment**

LLL	Less Battery Holder, batteries, and cover	-\$36.40
4B	4AA Battery kit	Standard
8B	8AA Battery kit	\$54.90

12. Select backset and latch bolt **Price adjustment**

LLL	Less Latch	-\$48.00
13-247	2-3/4" Backset, deadlatch, square corner, 1-1/8" x 2-1/4"	Standard
14-049	2-3/4" Backset, deadlatch anti-friction fire door latch, square corner, 1-1/8" x 2-1/4", 3/4" throw	\$254.00
14-051	2-3/8" Backset, deadlatch, square corner, 1-1/8" x 2-1/4"	No charge
14-050	3-3/4" Backset, deadlatch, square corner, 1-1/8" x 2-1/4"	\$15.00
43-001	5" Backset extension link, deadlatch	\$47.00
39-030 ⁷	Rabbeted latch and strike kit, 605 and 626 only	\$85.00

7. Adapts square corner latch and 2-3/4" square corner strike to 1/2" rabbeted door and frame.

13. Select strike plate **Price adjustment**

LLL	Less Strike Plate	-\$6.30
10-025	1-3/16" Lip, ANSI, no box, 1-1/14" x 4-7/8"	Standard
10-013 ⁸	1-1/8" Lip, square corner, T-strike, box, 1-1/8" - 2-3/4"	No charge
10-016	1-1/8" Lip, square corner, T-strike, deep box, fire door latch	\$22.20
K510-066	Box for ANSI strike (Must be specific)	No charge

8. 1-1/2" Lip available, must specify 1-1/2" Lip \$9.90.

14. Select door thickness **Price adjustment**

134	1-3/4"	Standard
Example 138	1-3/8" to 2-3/4", Shims included (Specify in 1/8" increments)	\$83.00

15. Select options **Price adjustment**

BAA ⁹	BAA Compliant product	\$125.00
------------------	-----------------------	----------

9. BAA compliant products must have the cover letter on page 306 included with the order. Failure to use this cover letter will result in the customer receiving non-BAA compliant product with no recourse for an RMA or refund. BAA compliant product requires a longer lead time, please contact customer service for details.

Accessories available, see pages 175–178. Accessories include Decorative plates, SUS A-KIT, etc.

Credentials available, see pages 16–20.

AD-250 STANDALONE RIGHTS ON CARD
MORTISE/MORTISE DEADBOLT

1-3. Select chassis		Price
AD-250-MS	Mortise	\$3,262.00
AD-250-MD	Mortise Deadbolt	\$3,308.00



AD-250-MS-70-MGK

4. Select function	(Note: Locking function capabilities are determined by users access control system.)	Price adjustment
70 ¹	Storeroom (Not available on Mortise Deadbolt)	Standard
50 ¹	Office/Classroom (Not available on Mortise Deadbolt)	\$10.00
40 ²	Privacy	\$10.00
60 ²	Apartment	\$10.00

1. Less Door Position Switch, use suffix LDP. -\$27.00
2. Inside Push Button (IPB) only included with Mortise (MS) chassis. Mortise Deadbolt (MD) chassis comes with LED indicator only. \$10.00 charge does not apply to Mortise Deadbolt (MD) chassis.

5. Select reader	(Note: Reflects price adder to base magnetic swipe reader price of \$923.30)	Price adjustment
LLL ³	Less Reader	-\$923.00
MS	Magnetic Stripe (Swipe)	No charge
MSK	Magnetic Stripe (Swipe) + Keypad	\$94.00
MG	Magnetic Stripe (Insert)	\$24.00
MGK	Magnetic Stripe (Insert) + Keypad	\$118.00



MG



MS

3. For reader module accessories sold separately, see page 175.

6. Select lever ⁴		Price adjustment
LLL	Less interior and exterior levers	-\$91.30
Standard options	SPA (Sparta), RHO (Rhodes), ATH (Athens), TLR (Tubular), BRW (Broadway), BRK (Boardwalk), LAT (Latitude), LON (Longitude)	No charge

4. Tactile Warning use 8AT for Athens, 8RO for Rhodes, 8SP for Sparta and 8TR for Tubular. \$67.00 per lever. Applied to exterior lever only unless otherwise specified. Not available with 643e finish.

7. Select finish		Price adjustment
626	Satin Chrome	No charge
605	Bright Brass	\$166.00
606	Satin Brass	\$166.00
612	Satin Bronze	\$166.00
619	Satin Nickel	\$166.00
625	Bright Chrome	\$166.00
643e	Aged Bronze	\$166.00
626AM	Satin Chrome Antimicrobial	\$215.00

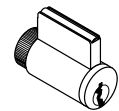

MSK

 Full Cylinder
P6, L, L-SAR, L-FA7

8. Select cylinder type		Price adjustment	
		Open	Restricted
<input type="checkbox"/> ● P6	With Cylinder, Schlage - (Everest 29 S123, 6-pin KIL standard)	No charge	\$30.00
	Less Cylinder, Schlage, Falcon, 6-pin KIL	-\$90.00	-\$90.00
<input type="checkbox"/> ● R	With Cylinder, Schlage 6-pin (Everest 29 S123 standard) FSIC	\$102.00	\$132.00
	Less Cylinder, Schlage, 6-pin FSIC	-\$55.00	-\$55.00
<input type="checkbox"/> ● G	With Cylinder, Schlage 7-pin (Everest 29R standard) (factory master keyed only) SFIC	N/A	\$113.00
	Less Cylinder, Schlage, Falcon, Competitive OEM's, 7-pin (SFIC)	-\$55.00	-\$55.00
	L-SAR Less Cylinder, Sargent (10L + 11L), 6-pin KIL (Only RHO, 8RO, SPA, 8SP, TLR, 8TR, ATH, 8AT lever styles)	No charge	No charge
	L-CO6 Less Cylinder, Corbin, 6-pin KIL (Only RHO, 8RO, SPA, 8SP lever styles)	No charge	No charge
	J-SAR Less Cylinder, Sargent 6300, 6-pin FSIC	No charge	No charge
	J-CO6 Less Cylinder, Corbin 8000, 6-pin FSIC	No charge	No charge
	J-CO7 Less Cylinder, Corbin 8000-7, 7-pin FSIC, (Only RHO, 8RO, SPA, 8SP, TLR and 8TR)	No charge	No charge
	J-MED Less Cylinder, Medeco 32*0201, 6-pin FSIC (Only RHO, 8RO, SPA, 8SP lever styles)	No charge	No charge
	J-YA6 Less Cylinder, Yale 1210 or Medeco 31*0100, 6-pin FSIC	No charge	No charge
	J-YA7 Less Cylinder, Yale 1220, 7-pin FSIC (Only RHO, 8RO, SPA, 8SP lever styles)	No charge	No charge
	L-FA7 Less Cylinder, Falcon, 7-pin, KIL (Only RHO, 8RO, SPA, 8SP lever styles)	No charge	No charge

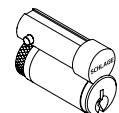
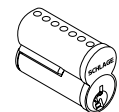
 FSIC Format
R, J, J-SAR, J-CO6,
J-CO7, J-YA6

 SFIC Format
B, G

- Master Keyed cylinders can be specified and will be shipped in lock packaging. For Master Keying System Summary form which should accompany the master keyed order, see page 296.

- △ For master keying, an additional charge of \$28.30 each applies. Specify line item 50-210.
 - Control keys for installation/removal of interchangeable cores are not furnished and must be ordered separate.
- For additional assistance on Master Keying as well as restricted keyways, please contact customer service.



AD-250 STANDALONE RIGHTS ON CARD

MORTISE/MORTISE DEADBOLT

9. Select keying type **Price adjustment**

Open keyway families: KIL or FSIC ⁵		
S123	Everest 29 S (Key in Lever or FSIC)	Standard
C123	Everest C	No charge
C/CE/E/EF/F/FG/G	Classic Obverse	No charge
Restricted keyway families: KIL or FSIC ^{5,6}		
29T	Everest 29 T	\$30.00
D	Everest D	\$30.00
Classic Restricted	Quad, Numbered, Reverse	\$30.00
Restricted keyway families: SFIC ⁷		
29 R	Everest 29 R	No charge
B	Everest B	No charge

5. Full size key systems (Everest 29 S and T, Everest C and D, Obverse and Quad) are available in Primus and Primus XP key system and must be ordered separately. Lock should be ordered less cylinder and Primus cylinder should be a separate line.
6. Everest restricted keyways require a Letter of Authorization to be submitted with the order. See page 302 for sample Letter of Authorization.
7. Master keyed cylinders can be specified and will be shipped in lock packaging. For Master Keying System Summary form which should accompany the master keyed order, see page 296.

10. Select handing (field reversible) **Price adjustment**

RH	Right handed	No charge
LH	Left handed	No charge
RHR	Right handed reverse	No charge
LHR	Left handed reverse	No charge

11. Select battery **Price adjustment**

LLL	Less Battery Holder, batteries, and cover	-\$36.40
4B	4AA Battery kit	Standard
8B	8AA Battery kit	\$54.90

12. Select mortise lock armor front **Price adjustment**

LLL	Less Armor Front	-\$23.60
09-663	1-1/4" Wide square corner, latch for MS	Standard
09-669	1-1/16" Wide square corner, latch, options for MS	No charge
09-666	1-1/4" Wide square corner, latch x deadbolt for MD	Standard
09-672	1-1/16" Wide square corner, latch x deadbolt, options for MD	No charge

13. Select strike plate **Price adjustment**

LLL	Less Strike	-\$18.40
10-072	1-1/4" x 4-7/8" Square corner + box; 1-3/16" lip length	Standard
10-072xx	1-1/4" x 4-7/8" Square corner + box; specify lip length (xx) as 1" or 1-1/2"	No charge
10-072xx	1-1/4" x 4-7/8" Square corner + box; specify lip length (xx) as 1-3/4"	\$45.00
10-075 ⁸	1/2" Rabbeted	\$155.00
37-015	Strike frame reinforcer, specify 37-015	No charge

8. For 1-3/4" thick doors, use wide armor front. For over 1-3/4" thick door extended equally (EE) use 1-1/4" wide armor front.
- ⁸ Extended lead time, consult customer service.

14. Select door thickness **Price adjustment**

134	1-3/4"	Standard
Example 138	1-3/8" to 2-3/4", Shims included (Specify in 1/8" increments)	\$83.00

15. Select options **Price adjustment**

BAA ⁹	BAA Compliant product	\$125.00
------------------	-----------------------	----------

9. BAA compliant products must have the cover letter on page 306 included with the order. Failure to use this cover letter will result in the customer receiving non-BAA compliant product with no recourse for an RMA or refund. BAA compliant product requires a longer lead time, please contact customer service for details.

AD-250 STANDALONE RIGHTS ON CARD EXIT TRIM

1-3. Select chassis/exit trim type (Note: See page 142 for exit device compatibility.)		Price
AD-250-993R	Exit Rim / Concealed Vertical Rod (Metal Door) / Concealed Vertical Cable (Metal Door)	\$3,342.00
AD-250-993S	Exit Surface Vertical Rod	\$3,379.00
AD-250-993M	Exit Mortise Lock	\$3,379.00

4. Select function (Note: Locking function capabilities are determined by users access control system.)		Price adjustment
70 ¹	Storeroom	Standard
50 ¹	Office/Classroom	\$10.00
40	Privacy	\$10.00
60	Apartment	\$10.00

1. Less Door Position Switch, use suffix LDP. -\$27.00

5. Select reader (Note: Reflects price adder to base magnetic swipe reader price of \$923.00)		Price adjustment
LLL ²	Less Reader	-\$923.00
MS	Magnetic Stripe (Swipe)	No charge
MSK	Magnetic Stripe (Swipe) + Keypad	\$94.00
MG	Magnetic Stripe (Insert)	\$24.00
MGK	Magnetic Stripe (Insert) + Keypad	\$118.00

2. For reader module accessories sold separately, see page 175.

6. Select lever ³		Price adjustment
LLL	Less interior and exterior levers	-\$91.30
Standard options	SPA (Sparta), RHO (Rhodes), ATH (Athens), TLR (Tubular), BRW (Broadway), BRK (Boardwalk), LAT (Latitude), LON (Longitude)	No charge

3. Tactile Warning use 8AT for Athens, 8RO for Rhodes, 8SP for Sparta and 8TR for Tubular. \$67.00 per lever. Applied to exterior lever only unless otherwise specified. Not available with 643e finish.

7. Select finish		Price adjustment
626	Satin Chrome	No charge
605	Bright Brass	\$166.00
606	Satin Brass	\$166.00
612	Satin Bronze	\$166.00
619	Satin Nickel	\$166.00
625	Bright Chrome	\$166.00
643e	Aged Bronze	\$166.00
626AM	Satin Chrome Antimicrobial	\$215.00

8. Select cylinder type		Price adjustment	
		Open	Restricted
<input type="checkbox"/> ● P6	With Cylinder, Schlage - (Everest 29 S123, 6-pin KIL standard)	No charge	\$30.00
L	Less Cylinder, Schlage, Falcon, 6-pin KIL	-\$90.00	-\$90.00
<input type="checkbox"/> ● R	With Cylinder, Schlage 6-pin (Everest 29 S123 standard) FSIC	\$102.00	\$132.00
J	Less Cylinder, Schlage, 6-pin FSIC	-\$55.00	-\$55.00
<input type="checkbox"/> ● G	With Cylinder, Schlage 7-pin (Everest 29R standard) (factory master keyed only) SFIC	N/A	\$113.00
B	Less Cylinder, Schlage, Falcon, Competitive OEM's, 7-pin (SFIC)	-\$55.00	-\$55.00
L-SAR	Less Cylinder, Sargent (10L + 11L), 6-pin KIL (Only RHO, 8RO, SPA, 8SP, TLR, 8TR, ATH, 8AT lever styles)	No charge	No charge
L-CO6	Less Cylinder, Corbin, 6-pin KIL (Only RHO, 8RO, SPA, 8SP lever styles)	No charge	No charge
J-SAR	Less Cylinder, Sargent 6300, 6-pin FSIC	No charge	No charge
J-CO6	Less Cylinder, Corbin 8000, 6-pin FSIC	No charge	No charge
J-CO7	Less Cylinder, Corbin 8000-7, 7-pin FSIC, (Only RHO, 8RO, SPA, 8SP, TLR and 8TR)	No charge	No charge
J-MED	Less Cylinder, Medeco 32*0201, 6-pin FSIC (Only RHO, 8RO, SPA, 8SP lever styles)	No charge	No charge
J-YA6	Less Cylinder, Yale 1210 or Medeco 31*0100, 6-pin FSIC	No charge	No charge
J-YA7	Less Cylinder, Yale 1220, 7-pin FSIC (Only RHO, 8RO, SPA, 8SP lever styles)	No charge	No charge
L-FA7	Less Cylinder, Falcon, 7-pin, KIL (Only RHO, 8RO, SPA, 8SP lever styles)	No charge	No charge

● Master Keyed cylinders can be specified and will be shipped in lock packaging. For Master Keying System Summary form which should accompany the master keyed order, see page 296.

△ For master keying, an additional charge of \$28.30 each applies. Specify line item 50-210.

Control keys for installation/removal of interchangeable cores are not furnished and must be ordered separate.

For additional assistance on Master Keying as well as restricted keyways, please contact customer service.



AD-250-993-70-MGK



MG



MS



MSK

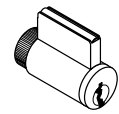

Full Cylinder
P6, L, L-SAR, L-FA7

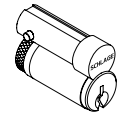

FSIC Format
R, J, J-SAR, J-CO6,
J-CO7, J-YA6

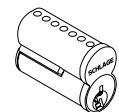

SFIC Format
B, G



AD-250 STANDALONE RIGHTS ON CARD EXIT TRIM

9. Select keying type **Price adjustment**

Open keyway families: KIL or FSIC⁴		
S123	Everest 29 S (Key in Lever or FSIC)	Standard
C123	Everest C	No charge
C/CE/E/EF/F/FG/G	Classic Obverse	No charge
Restricted keyway families: KIL or FSIC^{4,5}		
29T	Everest 29 T	\$30.00
D	Everest D	\$30.00
Classic Restricted	Quad, Numbered, Reverse	\$30.00
Restricted keyway families: SFIC⁶		
29 R	Everest 29 R	No charge
B	Everest B	No charge

4. Full Size key systems (Everest 29 S and T, Everest C and D, Obverse and Quad) are available in Primus and Primus XP key system and must be ordered separately. Lock should be ordered less cylinder and Primus cylinder should be a separate line.
5. Everest Restricted Keyways require a Letter of Authorization to be submitted with the order. See page 302 for sample Letter of Authorization.
6. Master Keyed cylinders can be specified and will be shipped in lock packaging. For Master Keying System Summary form which should accompany the master keyed order, see page 296.

10. Select handing (field reversible) **Price adjustment**

RHR	Right handed reverse	No charge
LHR	Left handed reverse	No charge

11. Select battery **Price adjustment**

LLL	Less Battery Holder, batteries, and cover	-\$36.40
4B	4AA Battery kit	Standard
8B	8AA Battery kit	\$54.90

12. – 13. No selection required**14. Select door thickness** **Price adjustment**

134	1-3/4"	Standard
Example 200	1-3/4" to 2-3/4", (Specify in 1/8" increments)	\$83.00

15. Select options **Price adjustment**

BAA ⁷	BAA Compliant product	\$125.00
------------------	-----------------------	----------

7. BAA compliant products must have the cover letter on page 306 included with the order. Failure to use this cover letter will result in the customer receiving non-BAA compliant product with no recourse for an RMA or refund. BAA compliant product requires a longer lead time, please contact customer service for details.

Accessories available, see pages 175–178. Accessories include Decorative plates, SUS A-KIT, etc.

Credentials available, see pages 16–20.

AD-993

NON-FUNCTIONING DUMMY TRIM FOR EXIT



1-4. Select chassis/exit trim type/reader (Note: See page 142 for exit device compatibility.)		Price
AD-993LLL	Dummy Trim Less Reader for Exit Rim / Concealed Vertical Rod ¹ / Concealed Vertical Cable / Surface Vertical Rod / Mortise Lock ¹	\$905.00
AD-993DT	Dummy Trim with "Dummy" Reader Cover for Exit Rim / Concealed Vertical Rod / Surface Vertical Rod ¹ / Mortise Lock	\$921.00

1. Metal door only.

5. Select lever ²		Price adjustment
LLL	Less interior and exterior levers	-\$36.50
SPA	Sparta	No charge
RHO	Rhodes	No charge
ATH	Athens	No charge
TLR	Tubular	No charge
BRW	Broadway	No charge
BRK	Boardwalk	No charge
LAT	Latitude	No charge
LON	Longitude	No charge

2. Tactile Warning use 8AT for Athens, 8RO for Rhodes, 8SP for Sparta and 8TR for Tubular. \$67.00 per lever. Applied to exterior lever only unless otherwise specified. Not available with 643e finish.

6. Select finish		Price adjustment
626	Satin Chrome	No charge
605	Bright Brass	\$166.00
606	Satin Brass	\$166.00
612	Satin Bronze	\$166.00
619	Satin Nickel	\$166.00
625	Bright Chrome	\$166.00
643e	Aged Bronze	\$166.00
626AM	Satin Chrome Antimicrobial	\$215.00

7. Select cylinder type		Price adjustment	
		Open	Restricted
<input type="checkbox"/> ● P6	With Cylinder, Schlage - (Everest 29 S123, 6-pin KIL standard)	No charge	\$30.00
L	Less Cylinder, Schlage, Falcon, 6-pin KIL	-\$90.00	-\$90.00
<input type="checkbox"/> ● R	With Cylinder, Schlage 6-pin (Everest 29 S123 standard) FSIC	\$102.00	\$132.00
J	Less Cylinder, Schlage, 6-pin FSIC	-\$55.00	-\$55.00
<input type="checkbox"/> ● G	With Cylinder, Schlage 7-pin (Everest 29R standard) (factory master keyed only) SFIC	N/A	\$113.00
B	Less Cylinder, Schlage, Falcon, Competitive OEM's, 7-pin (SFIC)	-\$55.00	-\$55.00
L-SAR	Less Cylinder, Sargent (10L + 11L), 6-pin KIL (Only RHO, 8RO, SPA, 8SP, TLR, 8TR, ATH, 8AT lever styles)	No charge	No charge
L-CO6	Less Cylinder, Corbin, 6-pin KIL (Only RHO, 8RO, SPA, 8SP lever styles)	No charge	No charge
J-SAR	Less Cylinder, Sargent 6300, 6-pin FSIC	No charge	No charge
J-CO6	Less Cylinder, Corbin 8000, 6-pin FSIC	No charge	No charge
J-CO7	Less Cylinder, Corbin 8000-7, 7-pin FSIC, (Only RHO, 8RO, SPA, 8SP, TLR and 8TR)	No charge	No charge
J-MED	Less Cylinder, Medeco 32*0201, 6-pin FSIC (Only RHO, 8RO, SPA, 8SP lever styles)	No charge	No charge
J-YA6	Less Cylinder, Yale 1210 or Medeco 31*0100, 6-pin FSIC	No charge	No charge
J-YA7	Less Cylinder, Yale 1220, 7-pin FSIC (Only RHO, 8RO, SPA, 8SP lever styles)	No charge	No charge
L-FA7	Less Cylinder, Falcon, 7-pin, KIL (Only RHO, 8RO, SPA, 8SP lever styles)	No charge	No charge

● Master Keyed cylinders can be specified and will be shipped in lock packaging. For Master Keying System Summary form which should accompany the master keyed order, see page 296.

△ For master keying, an additional charge of \$28.30 each applies. Specify line item 50-210.

 Control keys for installation/removal of interchangeable cores are not furnished and must be ordered separate.

For additional assistance on Master Keying as well as restricted keyways, please contact customer service.

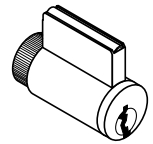
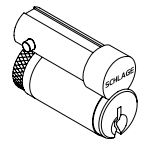
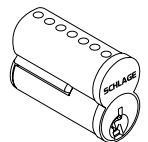

AD993DT

 Full Cylinder
P6, L, L-SAR, L-FA7

 FSIC Format
R, J, J-SAR, J-CO6,
J-CO7, J-YA6

 SFIC Format
B, G



AD-993

NON-FUNCTIONING DUMMY TRIM FOR EXIT

8. Select keying type **Price adjustment**

Open keyway families: KIL or FSIC ³		
S123	Everest 29 S (Key in Lever or FSIC)	Standard
C123	Everest C	No charge
C/CE/E/EF/F/FG/G	Classic Obverse	No charge
Restricted keyway families: KIL or FSIC ^{3,4}		
29T	Everest 29 T	\$30.00
D	Everest D	\$30.00
Classic Restricted	Quad, Numbered, Reverse	\$30.00
Restricted keyway families: SFIC ⁵		
29 R	Everest 29 R	No charge
B	Everest B	No charge

3. Full Size key systems (Everest 29 S and T, Everest C and D, Obverse and Quad) are available in Primus and Primus XP key system and must be ordered separately. Lock should be ordered less cylinder and Primus cylinder should be a separate line.
4. Everest Restricted Keyways require a Letter of Authorization to be submitted with the order. See page 302 for sample Letter of Authorization.
5. Master Keyed cylinders can be specified and will be shipped in lock packaging. For Master Keying System Summary form which should accompany the master keyed order, see page 296.

9. Select handing (field reversible) **Price adjustment**

RHR	Right handed reverse	No charge
LHR	Left handed reverse	No charge

10. – 12. No selection required**13. Select door thickness** **Price adjustment**

134	1-3/4"	Standard
Example 178	1-7/8" to 2-3/4", (Specify in 1/8" increments)	\$83.00

14. Select options **Price adjustment**

BAA ⁶	BAA Compliant product	\$125.00
------------------	-----------------------	----------

6. BAA compliant products must have the cover letter on page 306 included with the order. Failure to use this cover letter will result in the customer receiving non-BAA compliant product with no recourse for an RMA or refund. BAA compliant product requires a longer lead time, please contact customer service for details.

Accessories available, see pages 175–178.

Credentials available, see pages 16–20.

AD Series Exit trim

The AD993DT Non-Functioning Dummy Trim comes with a universal mounting plate and is compatible with the following exit devices:

- **Von Duprin 98/99 and 98/99XP**
 - Rim, Concealed Vertical Rod (metal door only), Concealed Vertical Cable (metal door only), Surface Vertical Rod, Mortise.
 - Low current Request-to-Exit Switch optional for future network migration.
- **Von Duprin 22/22F**
 - Rim, Surface Vertical Rod
- **Falcon 25** – Rim
- **Sargent 80 Series** (Narrow design and reversible rim exits not compatible) – Rim
- **Corbin Russwin 5000 Series** – Rim
- **Yale 7000** – Rim
- **Dorma 9300** – Rim
- **Precision 21** – Rim (2100 converts to 21 with Precision's BP21 Kit)

PARTS AND ACCESSORIES

ANDROID™ CABLE (For use with SUS Android App)			
Product description	Product specification	Specify	Price
USB & 2-PIN Android cable	Used to connect Android device to USB and 2-PIN locks and accessories	47282796 SUS A-KIT	\$279.00

HANDHELD DEVICE ACCESSORIES (Legacy Product Support)			
Product description	Product specification	Specify	Price
Serial cable	Used to connect current model HHD (BM170) directly to legacy serial products without the need of a CIP	HH-2PIN SERIAL	\$218.00
Serial cable ¹	Used to connect previous model HHD (BM150) with CIP to program serial products	HH-SERIAL	\$195.00
Null converter	Used to connect Handheld Device to WA Series PIM, using HH-SERIAL serial cable (compatible to current and previous model HHDs)	PIMWA-CV	\$40.00
Computer interface module (CIP) ¹	Used to program serial products using HH-SERIAL serial cable	P512112	\$507.00
CIP with iButton Reader ¹	Used to program serial products using HH-SERIAL serial cable	P101203	\$535.00

1. Not compatible to current HHD (BM170)

READER MODULES (Select by Technology)	Available finishes									
	605	606	612	613	619	622	625	626	643e	626AM
	▪	▪	▪	N/A	▪	N/A	▪	▪	▪	▪
Product description	Specify		Price							
	Part number	Finish								
Keypad only reader module	KP	.[Finish]	\$797.00							
Magnetic stripe (Insert) reader module - (Track 1, 2, or 3)	MG	.[Finish]	\$971.00							
Magnetic stripe (Insert) with keypad reader module - (Track 1, 2, or 3)	MGK	.[Finish]	\$1,071.00							
Magnetic stripe (Swipe) reader module - (Track 1, 2, or 3)	MS	.[Finish]	\$947.00							
Magnetic stripe (Swipe) with keypad reader module - (Track 1, 2, or 3)	MSK	.[Finish]	\$1,048.00							
Multi-technology reader module - (125 kHz Proximity and 13.56 MHz Smart)	MT	.[Finish]	\$1,095.00							
Multi-technology with keypad reader module - (125 kHz Proximity and 13.56 MHz Smart)	MTK	.[Finish]	\$1,193.00							
Smart Technology iClass compatible reader	SI	.[Finish]	\$1,267.00							
Smart Technology iClass compatible reader + keypad	SIK	.[Finish]	\$1,359.00							
FIPS Multi-technology with keypad reader module - (125 kHz Proximity and 13.56 MHz Smart)	FMK	.[Finish]	\$1,499.00							
Dummy trim reader cover	DT	.[Finish]	\$45.00							

READER MODULE ACCESSORIES		
Product description	Specify	Price
Magnetic stripe cleaning cards	510310	\$57.20



PARTS AND ACCESSORIES

COMMUNICATION MODULE KITS		Available finishes									
		605	606	612	613	619	622	625	626	643e	626AM
		▪	▪	▪	N/A	▪	N/A	▪	▪	▪	▪
Product description	Product specification	Specify		Price							
		Product ID	Finish								
AD-200/AD-250 Offline communication kit (Cover)	Storeroom Functions (Cylindrical and Exit Chassis)	COM200C	.[Finish]	\$233.00							
AD-200/AD-250 Offline communication kit (Cover w/indicator lens) ¹	Privacy/Apartment Functions (Mortise Deadbolt Chassis)	COM200L	.[Finish]	\$233.00							
AD-200/AD-250 Offline communication kit (Cover w/push button) ¹	Privacy/Apartment/Office/Classroom Functions (Cylindrical and Mortise Chassis)	COM200P	.[Finish]	\$233.00							
AD-300 Hardwired Communication Kit (Cover w/Indicator Lens, RS485 Communication PCB) ^{1,2}	Storeroom Functions (Cylindrical, Mortise and Exit Chassis) Privacy/Apartment Functions (Mortise Deadbolt Chassis)	COM300L	.[Finish]	\$516.00							
AD-300 Hardwired communication kit (Cover w/push button, RS485 communication PCB) ^{1,2}	Privacy/Apartment/Office/Classroom Functions (Cylindrical and Mortise Chassis)	COM300P	.[Finish]	\$516.00							
AD-400 Wireless Communication Kit (Cover w/indicator lens, 900MHz communication PCB) ^{1,2}	Storeroom Functions (Cylindrical, Mortise and Exit Chassis) Privacy/Apartment Functions (Mortise Deadbolt Chassis)	COM400L	.[Finish]	\$558.00							
AD-400 Wireless communication kit (Cover w/push button, 900MHz communication PCB) ^{1,2}	Privacy/Apartment/Office/Classroom Functions (Cylindrical and Mortise Chassis)	COM400P	.[Finish]	\$558.00							

1. Must order and install Door Position Switch #46929121 for proper operation.
2. Must order and install Pigtail Exit Adapter #23536774 for RX-LC switch if retrofitting AD-200-993 to AD-300-993 or AD-400-993.

	Class	Chassis	Type	Storeroom (70)	Office/ Classroom (50)	Apartment (60)	Privacy (40)
OFFLINE	AD-200 and AD-250	CY	Cylindrical	COM200C	COM200P	COM200P	COM200P
	AD-200 and AD-250	MS	Mortise	COM200C	COM200P	COM200P	COM200P
	AD-200 and AD-250	MD	Mortise Deadbolt	N/A	N/A	COM200L	COM200L
	AD-200 and AD-250	993	Exit trim	COM200C	N/A	N/A	N/A
NETWORKED	AD-300	CY	Cylindrical	COM300L	COM300P	COM300P	COM300P
	AD-300	MS	Mortise	COM300L	COM300P	COM300P	COM300P
	AD-300	MD	Mortise Deadbolt	N/A	N/A	COM300L	COM300L
	AD-300	993	Exit trim	COM300L	N/A	N/A	N/A
	AD-400	CY	Cylindrical	COM400L	COM400P	COM400P	COM400P
	AD-400	MS	Mortise	COM400L	COM400P	COM400P	COM400P
	AD-400	MD	Mortise Deadbolt	N/A	N/A	COM400L	COM400L
	AD-400	993	Exit trim	COM400L	N/A	N/A	N/A

Suffixes: C= Cover L= LED Only P= Pushbutton

Note: Connections other than Wiegand or Clock & Data may incur additional fee. Consult access control provider for details.

NETWORKED LOCKS

STANDALONE LOCKS

PARTS

PARTS AND ACCESSORIES

DOOR POSITION SWITCH		
Description	Specify	Price
Door Position Switch	46929121	See page 193

BATTERY COVER (Select by Battery Quantity)	Available finishes									
	605	606	612	613	619	622	625	626	643e	626AM
	▪	▪	▪	N/A	▪	N/A	▪	▪	▪	▪
Description	Specify		Price							
	Product ID	Finish								
4AA Battery cover (with screw)	4C (46929071)	.[Finish]	See page 196							
8AA Battery cover (with screw)	8C (46929105)	.[Finish]								

BATTERY HOLDER AND COVER KIT (Select by Battery Quantity)	Available finishes									
	605	606	612	613	619	622	625	626	643e	626AM
	▪	▪	▪	N/A	▪	N/A	▪	▪	▪	▪
Description	Specify		Price							
	Product ID	Finish								
4AA Battery holder and cover kit (Includes 4AA battery holder with cable, 4AA battery strap, battery strap screws, 4AA battery cover, cover screw, Torx® cover screw)	4B (46929055)	.[Finish]	See page 196							
8AA Battery holder and cover kit (Includes 8AA battery holder with cable, 8AA battery strap, battery strap screws, 8AA battery cover, cover screw, Torx cover screw, Mylar)	8B (46929089)	.[Finish]								

TORX® TAMPER SCREW PACK (Select by Chassis Type)		Available finishes									
		605	606	612	613	619	622	625	626	643e	626AM
		▪	▪	▪	N/A	▪	N/A	▪	▪	▪	▪
Chassis	Description	Specify		Price							
		Product ID	Finish								
Cylindrical	Torx tamper screw pack	23538812	.[Finish]	See page 197							
Mortise	Torx tamper screw pack	23538820	.[Finish]								
Exit	Torx tamper screw pack	23538838	.[Finish]								

DECORATIVE PLATE (Select by Size)		Available finishes									
		605 ¹	606	612	613	619	622	625	626	643e ¹	626AM
		▪	N/A	N/A	N/A	N/A	N/A	N/A	▪	▪	N/A
Size	Description	Specify		Price							
		Product ID	Finish								
1.5" x 3.25" x .105"	Decorative plate (with screws) - (Exit trim)	23631823	.[Finish]	See page 194							
1.7" x 3.5" x .075"	Decorative plate (with screws)	23760267	.[Finish]								
3.2" x 3.5" x .075"	Decorative plate (with screws)	23760283	.[Finish]								
6.0" x 3.5" x .075"	Decorative plate (with screws)	23760317	.[Finish]								
6.6" x 3.5" x .075"	Decorative plate (with screws)	23760325	.[Finish]								
8.0" x 3.5" x .075"	Decorative plate (with screws)	23760309	.[Finish]								
8.0" x 3.5" x .075"	Decorative plate (with screws and welded standoff)	23760291	.[Finish]								
10.5" x 3.5" x .075"	Decorative plate (no screws necessary) - (under lock) ²	23760259	.[Finish]								
12.0" x 3.5" x .075"	Decorative plate (no screws necessary) - (under lock) ²	23760275	.[Finish]								

1. 626 Satin Chrome finish standard. Please consult Customer Care for 605 Bright Brass or 643E Aged Bronze.
2. Please consider overall Door Thickness when ordering.
3. Single Decorative plate. Interior and Exterior Decorative plates may be required.
4. Decorative plates may have multiple applications. Please see AD Series Retrofit Template Overlay guide at www.schlage.com/support for more information.

PARTS AND ACCESSORIES

SHIM PLATES (Note: Device is 0.063" thick)		
Description	Specify	Price
Interior shim plate - (for AD-200/250/300)	23458607	See page 193
Interior shim plate - (for AD-400)	23458565	
Exterior shim plate	23458599	

INSTALLATION TOOLS		
Description	Specify	Price
Universal clamp <ul style="list-style-type: none"> The universal clamp above is necessary when using the remaining products to ensure hole placement accuracy The "Universal" (Clamp and DPS) products are for use in all CO, AD and LE product installations 	40-286	\$662.00
AD Series cylindrical lock installation template	40-288	\$1,412.00
Universal cylindrical door position switch (DPS) installation template	40-292	\$217.00
AD Series mortise lock installation template	40-287	\$1,412.00
Universal mortise door position switch (DPS) installation template	40-291	\$215.00

Note: These metal lock and DPS templates require use of specially designed universal clamp to ensure drilling accuracy.

AD-200 STANDALONE ACCESSORIES			
Express level software package Note: Refer to Software Levels Data sheet for features and details.			
Product description	Product specification	Specify	Price
Express offline lock software	Recommended for offline locks of fewer than 1000 users and/or 100 access points. Reporting of last 1000 events capability will retrieve audit trails. Must be installed on a computer that meets the minimum requirements (refer to software data sheet)	SXPR-SFT-1	See page 240
Express level software package accessories			
Product description	Product specification	Specify	Price
Express computer interface module	Used to program legacy CM/CL/KC products, using HH-SERIAL serial cable	P512112	See page 240
Express computer interface module (with iButton)	Used to connect PC/laptop to access device	P101203	
Express female to female serial cable	Used to connect P101203 Computer Interface Module to PC/laptop	P394548	
Express male DB9 to USB 6" cable adapter	Used to connect a USB Port device to a Serial Port device	SDB9USBCBL	
Express magnetic stripe enrollment reader	-	CRM2	
Express proximity enrollment reader	-	CRP2	
USB/BLE (ENGAGE mobile app) MIFARE/EV1 PIV Enrollment reader		MT20	See page 30
Express installation and training			
Product description	Product specification	Specify	Price
Express installation and training	Includes software installation and training. Provided by Allegion Security and Safety Consultant remotely from factory. (No discounts apply)	SCH-EXP-INST	See page 240

REMOTE DOOR RELEASE		
Product description	Product specification	Price
Push button release options	AD-200 firmware enables the use of a wired remote release of the door. Many push button types are available.	See page 176

AD-250 ACCESSORIES			
Product description	Product specification	Specify	Price
Campus lock magnetic stripe encoder	ISO compatible high/low coercivity with female/male serial cable.	CL-ENCODER-2	\$6,788.00

Contents

Reader module.....	180
Interior escutcheon	180
Interior baseplate gasket	181
Exterior escutcheon	181
Exterior gasket kit.....	181
Base plate subassembly.....	182
Mounting hardware.....	182
Exterior spring cage.....	183
Tailpiece.....	184
Cylinders.....	186
Latches	186
Lever.....	187
Lock retractor	191
Mortise armor front.....	192
Strikes	193
Shim plates	193
Door position switch	193
Door thickness kit.....	194
Decorative plate	194
Miscellaneous.....	195

Finish codes and descriptions

BHMA code	Description
605	Bright brass
606	Satin brass
612	Satin bronze
619	Satin nickel
625	Bright chromium plated
626	Satin chrome
626AM	Satin stainless steel, antimicrobial
643e	Aged bronze

Customer service	Technical support
<ul style="list-style-type: none"> Order status Credit returns of non-defective products General sales questions <p>USA Allegion_Orders@allegion.com CAN Canada.CustomerService@allegion.com</p>	<ul style="list-style-type: none"> Technical questions/issues Returns of defective products Repairs <p>USA Electronic_Lock_TechProdSupport@allegion.com CAN Canada.TechServices@allegion.com</p>

PARTS AND ACCESSORIES

READER MODULE														
KP	MG	MGK	MS	MSK	MT/SI	MTK/SIK/FMK								
Available finishes					605	606	612	613	619	622	625	626	643e	626AM
					▪	▪	▪	N/A	▪	N/A	▪	▪	▪	▪
Description					Specify		Price							
					Part number	Finish								
Keypad only reader module					KP	[Finish]	See page 175							
Magnetic stripe (Insert) reader module - (Track 1, 2, or 3)					MG	[Finish]								
Magnetic stripe (Insert) with keypad reader module - (Track 1, 2, or 3)					MGK	[Finish]								
Magnetic stripe (Swipe) reader module - (Track 1, 2, or 3)					MS	[Finish]								
Magnetic stripe (Swipe) with keypad reader module - (Track 1, 2, or 3)					MSK	[Finish]								
Multi-technology reader module - (125 kHz Proximity and 13.56 MHz Smart)					MT	[Finish]								
Multi-technology with keypad reader module - (125 kHz Proximity and 13.56 MHz Smart)					MTK	[Finish]								
Smart Technology iClass compatible reader					SI	[Finish]								
Smart Technology iClass compatible reader + keypad					SIK	[Finish]								
FIPS Multi-technology with keypad reader module - (125 kHz Proximity and 13.56 MHz Smart)					FMK	[Finish]								
Dummy trim reader cover					DT	[Finish]								

READER MODULE SCREWS			
Description	Specify		Price
	Part number	Door thickness	
Screws, reader module assembly (1-3/8", 1-1/2", 1-5/8", 1-3/4", 1-7/8", 2", 2-1/8", 2-1/4", 2-3/8", 2-1/2", 2-5/8", and 2-3/4")	46928511	[]	\$15.00

MAGNETIC SWIPE CLEANING CARDS		
Description	Specify	Price
Magnetic stripe cleaning cards	510310	\$57.20

INTERIOR ESCUTCHEON (Select by Chassis Type)		Available finishes									
		605	606	612	613	619	622	625	626	643e	626AM
		▪	▪	▪	N/A	▪	N/A	▪	▪	▪	▪
Chassis type	Description	Specify		Price							
		Part number	Finish								
Cylindrical	Interior escutcheon (with baseplate screws)	46929014	[Finish]	\$111.00							
Mortise	Interior escutcheon (with baseplate screws)	46929014	[Finish]	\$111.00							
Mortise Deadbolt	Interior escutcheon (with baseplate screws)	46929022	[Finish]	\$111.00							
Exit	Interior escutcheon (with baseplate screws)	46929279	[Finish]	\$84.00							

INTERIOR BASEPLATE GASKET		
Description	Specify	Price
Interior baseplate gasket	46928982	\$50.00

PARTS AND ACCESSORIES

USB COVER PLUG, 10-PIECE BULK PACK			
Description	Original part number	Specify	Price
		New part number	
USB Cover plug (10-piece bulk pack)	46928719	46928719	\$37.00
USB Cover plug, exit (10-piece bulk pack)	-	47258550	\$37.00
Cable, USB, AD/CO, Exit	-	47253409	\$36.90

EXTERIOR ESCUTCHEON (Select by Chassis Type)			Available finishes									
Chassis type	Description	Original part number	605	606	612	613	619	622	625	626	643e	626AM
			▪	▪	▪	N/A	▪	N/A	▪	▪	▪	▪
		Specify		Price								
		New part number	Finish									
Cylindrical	Exterior escutcheon with baseplate screws	46928743	46928743	.[Finish]		\$186.00						
Mortise	Exterior escutcheon with baseplate screws	46928750	46928743	.[Finish]		\$186.00						
Exit	Exterior escutcheon with baseplate screws	46928750	47258398	.[Finish]		\$184.00						
	Exterior escutcheon with baseplate screws	46928743										

EXTERIOR ESCUTCHEON, 10-PIECE BULK PACK (Select by Chassis Type)			Available finishes									
Chassis type	Description	Original part number	605	606	612	613	619	622	625	626	643e	626AM
			▪	▪	▪	N/A	▪	N/A	▪	▪	▪	▪
		Specify		Price								
		New part number	Finish									
Cylindrical	Exterior escutcheon with baseplate screws	23608532	23608532	.[Finish]		\$930.70						
Mortise	Exterior escutcheon with baseplate screws	23608540	23608532	.[Finish]		\$930.70						
Exit	Exterior escutcheon with baseplate screws	23608540	47260731	.[Finish]		\$931.00						
	Exterior escutcheon with baseplate screws	23608532										

EXTERIOR GASKET KIT (Select by Chassis Type)				
Chassis type	Description	Original part number	Specify	Price
			New part number	
Cylindrical	Exterior gasket kit (Includes exterior baseplate gasket, spindle cover seal, reader O-ring)	46929154	47260740	\$74.00
Mortise	Exterior gasket kit (Includes exterior baseplate gasket, spindle cover seal, reader O-ring)	46929162	47260740	\$74.00
Exit	Exterior gasket kit (Includes exterior baseplate gasket, spindle cover seal, reader O-ring)	46929162	47260741	\$74.00

INTERIOR BASEPLATE SUBASSEMBLY (Select by Chassis Type)					
Chassis type	Description	Original part number	Specify		Price
			New part number	Class	
Cylindrical	Interior baseplate subassembly - (Less Lever, Less Escutcheon, Less Spring Cage)	46928990	47261347	.[Class]	\$1,355.00
Mortise	Interior baseplate subassembly - (Less Lever, Less Escutcheon, Less Spring Cage)	46928990	47261347	.[Class]	\$1,355.00
Exit	Interior baseplate subassembly - (Less Escutcheon, Less Battery Cover, Less Communication Module Cover)	46929253	46929253	.[Class]	\$982.60

PARTS AND ACCESSORIES

EXTERIOR BASEPLATE SUBASSEMBLY (Select by Chassis Type)					
Chassis type	Description	Original part number	Specify		Price
			New part number	Cylinder detail	
Cylindrical	Exterior baseplate subassembly - (Less Lever, Less Cylinder, Less Escutcheon)	46928529	47260732	.[Cylinder]	\$1,146.00
Mortise	Exterior baseplate subassembly - (Less Lever, Less Cylinder, Less Escutcheon)	46928537	47260738	.[Cylinder]	\$1,198.00
Exit	Exterior baseplate subassembly - (Less Lever, Less Cylinder, Less Escutcheon)	46928545	47260739	.[Cylinder]	\$1,146.00

INTERIOR BASEPLATE SPACER FOR SVR			
Chassis type	Description	Specify	Price
Exit	Interior baseplate spacer for SVR (w/baseplate mounting screws, surface mount screws)	46929238	\$69.10

INTERIOR WIRELESS COVER SPACER FOR SVR			
Chassis type	Description	Specify	Price
Exit	Interior wireless cover spacer for SVR (with surface mount screw)	46929246	\$49.80

INTERIOR MOUNTING PLATE			
Chassis type	Description	Specify	Price
Exit	Interior mounting plate (with screws)	46929030	\$74.00

INTERIOR SPRING CAGE		Specify	
Description	Original part number	New part number	Price
Interior spring cage (with screws)	46929006	47260743	\$84.00

EXIT DEVICE MOUNTING HARDWARE KIT		Available finishes									
		605	606	612	613	619	622	625	626	643e	626AM
Chassis type	Description	Original part number	Specify				Price				
			New part number	Device type	Finish	Door thickness					
Exit	Exit device mounting hardware kit (upper mounting bolts, lower mounting sex-bolts, reader mounting bolts, finish washers, screws)	46929287	47260744	.[993R, 993S or 993M]	.[Finish]	.[]	\$124.00				

NETWORKED LOCKS

STANDALONE LOCKS

PARTS

PARTS AND ACCESSORIES

EXTERIOR SPRING CAGE (WITH SCREWS)			
(Select by Chassis Type, Cylinder OEM, Cylinder Type, Cylinder Detail)			
Cylindrical	New part number	Original part number	Price
Schlage, KIL, P6/L	47258543	46928552	\$104.00
Schlage, FSIC, R/J		46928552	
Schlage, SFIC, G/B		46928560	
Falcon, KIL, L-FA7 (7-pin)		23845969	
Corbin Russwin, FSIC, J-CO6 (6-pin)		46928586	
Corbin Russwin, FSIC, J-CO7 (7-pin)		23990674	
Sargent, KIL, L-SAR (6-pin)		46928578	
Sargent, FSIC, J-SAR (6-pin)		46928586	
Medeco, FSIC, J-MED (6-pin)		24281735	
Yale, FSIC, J-YA6 (6-pin)	46928644		
Yale, FSIC, J-YA7 (7-pin)	24281768		
Mortise	New part number	Original part number	Price
Schlage, KIL, P6/L	47258543	46928602	\$104.00
Schlage, FSIC, R/J		46928610	
Schlage, SFIC, G/B		46928560	
Falcon, KIL, L-FA7 (7-pin)		23845977	
Corbin Russwin, FSIC, J-CO6 (6-pin)		46928636	
Corbin Russwin, FSIC, J-CO7 (7-pin)		23988033	
Sargent, KIL, L-SAR (6-pin)		46928628	
Sargent, FSIC, J-SAR (6-pin)		46928636	
Medeco, FSIC, J-MED (6-pin)		24281735	
Yale, FSIC, J-YA6 (6-pin)	46928644		
Yale, FSIC, J-YA7 (7-pin)	24281768		
Exit	New part number	Original part number	Price
Schlage, KIL, P6/L (Steel Levers)	47258545	46928651	\$252.00
Schlage, FSIC, R/J (Steel Levers)		46928553	
Schlage, SFIC, G/B (Steel Levers)		46928669	
Falcon, KIL, L-FA7 (7-pin) (Steel Levers) - (Except ATH, 8AT Lever Style)		23779838	
Corbin Russwin, FSIC, J-CO6 (6-pin) (Steel Levers)		46928693	
Corbin Russwin, FSIC, J-CO7 (7-pin) (Steel Levers) - (Except ATH, 8AT Lever Style)		23988017	
Sargent, KIL, L-SAR (6-pin) (Steel Levers)		46928677	
Sargent, FSIC, J-SAR (6-pin) (Steel Levers)		46928685	
Medeco, FSIC, J-MED (6-pin)		24289902	
Yale, FSIC, J-YA6 (6-pin) (Steel Levers)	46928701		
Yale, FSIC, J-YA7 (7-pin)	24289928		

EXTERIOR SPRING CAGE AND TAILPIECE KIT (FOR SCHLAGE), 10-PIECE BULK PACK			
(Select by Chassis, Cylinder OEM, Cylinder Type, Cylinder Detail)			
Cylindrical	New part number	Original part number	Price
Schlage, KIL, P6/L	47259238	23593270	\$1,026.00
Schlage, FSIC, R/J	47259239	23593288	\$1,027.00
Schlage, SFIC, G/B	47259240	23593304	\$1,026.00
Mortise	New part number	Original part number	Price
Schlage, KIL, P6/L	47259238	23593346	\$1,026.00
Schlage, FSIC, R/J	47259239	23593353	\$1,027.00
Schlage, SFIC, G/B	47259240	23593304	\$1,026.00
Exit	New part number	Original part number	Price
Schlage, KIL, P6/L	47259249	23593271	\$1,026.00
Schlage, FSIC, R/J	47259250	23593272	\$3,415.00
Schlage, SFIC, G/B	47259248	23593437	\$1,833.00
		23593510	

PARTS AND ACCESSORIES

EXTERIOR SPRING CAGE AND TAILPIECE KIT (FOR NON-SCHLAGE), SINGLE PIECE (Select by Chassis Type, Cylinder OEM, Cylinder Type, Cylinder Detail)			
Cylindrical	New part number	Original part number	Price
Falcon, KIL, L-FA7 (7-pin)	47259244	23845985	\$124.00
Corbin Russwin, FSIC, J-CO6 (6-pin)	47259242	23593320	\$538.00
Corbin Russwin, FSIC, J-CO7 (7-pin)		23990666	
Sargent, KIL, L-SAR (6-pin)	47259241	23593312	\$502.00
Sargent, FSIC, J-SAR (6-pin)	47259242	23593320	\$538.00
Medeco, FSIC, J-MED (6-pin)	47259245	24281792	\$566.00
Yale, FSIC, J-YA6 (6-pin)	47259243	23593395	\$566.00
Yale, FSIC, J-YA7 (7-pin)	47259246	24281826	\$497.00
Mortise	New part number	Original part number	Price
Falcon, KIL, L-FA7 (7-pin)	47259244	23845923	\$124.00
Corbin Russwin, FSIC, J-CO6 (6-pin)	47259242	23593387	\$538.00
Corbin Russwin, FSIC, J-CO7 (7-pin)		23988041	
Sargent, KIL, L-SAR (6-pin)	47259241	23593379	\$502.00
Sargent, FSIC, J-SAR (6-pin)	47259242	23593387	\$538.00
Medeco, FSIC, J-MED (6-pin)	47259245	24281792	\$566.00
Yale, FSIC, J-YA6 (6-pin)	47259243	23593395	\$566.00
Yale, FSIC, J-YA7 (7-pin)	47259246	24281826	\$497.00
Exit	New part number	Original part number	Price
Falcon, KIL, L-FA7 (7-pin)	47259254	23810872	\$130.00
Corbin Russwin, FSIC, J-CO6 (6-pin)	47259252	23593274	\$538.00
Corbin Russwin, FSIC, J-CO7 (7-pin) - (Except ATH, 8AT Lever Styles)		23988025	
Sargent, KIL, L-SAR (6-pin)	47259251	23593273	\$502.00
Sargent, FSIC, J-SAR (6-pin)	47259252	23593274	\$538.00
Medeco, FSIC, J-MED (6-pin)	47259255	24289936	\$547.00
Yale, FSIC, J-YA6 (6-pin)	47259253	23593275	\$547.00
Yale, FSIC, J-YA7 (7-pin)	47259257	24289944	\$467.00

TAILPIECE (FOR CYLINDER) (Select by Chassis Type, Cylinder OEM, Cylinder Type, Cylinder Detail)			
Cylindrical	New part number	Original part number	Price
Schlage, KIL, P6/L - (Everest/Primus/Modular Cylinders) ¹	47258186	C604-243	\$3.10
Schlage, KIL, P6/L - (Classic Cylinders) ¹		C603-524	
Schlage, FSIC, R/J	23446339	23446339	\$7.30
Falcon, KIL, L-FA7 (7-pin)	47258182	23779820	\$35.90
Universal, SFIC, B/BDC	47258187	46929456	\$21.90
Corbin Russwin, FSIC, J-CO6 (6-pin)	47258180	23433634	\$55.10
Corbin Russwin, FSIC, J-CO7 (7-pin)		23854516	
Sargent, KIL, L-SAR (6-pin) - (Compatible with 10L and 11L)	47258179	23433626	\$8.40
Sargent, FSIC, J-SAR (6-pin)	47258180	23433634	\$55.10
Medeco, FSIC, J-MED (6-pin)	47258183	23810898	\$129.30
Yale, FSIC, J-YA6 (6-pin) - (Compatible with Medeco 31)	47258181	23760366	\$70.60
Yale, FSIC, J-YA7 (7-pin)	47258184	23929722	\$47.60
Universal, SFIC, G/H	23446347	23446347	\$17.50
Corbin Russwin, KIL L-CO6	47258185	-	\$21.70
Mortise	New part number	Original part number	Price
Schlage, KIL, P6/L - (Everest/Primus/Modular Cylinders) ¹	47258186	23538077	\$3.10
Schlage, KIL, P6/L - (Classic Cylinders) ¹		23538085	
Schlage, FSIC, R/J	23446339	23446339	\$7.30
Falcon, KIL, L-FA7 (7-pin)	47258182	23779820	\$35.90
Universal, SFIC, B/BDC	47258187	46929456	\$21.90
Corbin Russwin, FSIC, J-CO6 (6-pin)	47258180	23443435	\$55.10
Corbin Russwin, FSIC, J-CO7 (7-pin)		23854516	
Sargent, KIL, L-SAR (6-pin) - (Compatible with 10L and 11L)	47258179	23443427	\$8.40

1. This part is shared with Schlage mechanical and defaults to the Schlage mechanical discount.

PARTS AND ACCESSORIES

EXTERIOR SPRING CAGE AND TAILPIECE KIT (FOR NON-SCHLAGE), SINGLE PIECE (Select by Chassis Type, Cylinder OEM, Cylinder Type, Cylinder Detail)			
Mortise (continued)	New part number	Original part number	Price
Sargent, FSIC, J-SAR (6-pin)	47258180	23443435	\$55.10
Medeco, FSIC, J-MED (6-pin)	47258183	23810898	\$129.30
Yale, FSIC, J-YA6 (6-pin) - (Compatible with Medeco 31)	47258181	23760366	\$70.60
Yale, FSIC, J-YA7 (7-pin)	47258184	23929722	\$47.60
Universal, SFIC, G/H	23446347	23446347	\$17.50
Corbin Russwin, KIL L-CO6	47258185	-	\$21.70
Exit	New part number	Original part number	Price
Schlage, KIL, P6/L - (Everest/Primus/Modular Cylinders) ¹	47258186	23538077	\$3.10
Schlage, KIL, P6/L - (Classic Cylinders) ¹		23538085	
Schlage, FSIC, R/J	23446339	23446339	\$7.30
Falcon, KIL, L-FA7 (7-pin)	47258182	23779820	\$35.90
Universal, SFIC, B/BDC	47258187	46929456	\$21.90
Universal, SFIC, G/H	23446347	N523-091	\$17.50
Corbin Russwin, FSIC, J-CO6 (6-pin)	47258180	23443435	\$55.10
Corbin Russwin, FSIC, J-CO7 (7-pin)		23854516	
Sargent, KIL, L-SAR (6-pin)	47258179	23443427	\$8.40
Sargent, FSIC, J-SAR (6-pin)	47258180	23443435	\$55.10
Medeco, FSIC, J-MED (6-pin)	47258183	23810898	\$129.30
Yale, FSIC, J-YA6 (6-pin) - (Compatible with Medeco 31)	47258181	23760366	\$70.60
Yale, FSIC, J-YA7 (7-pin)	47258184	23929722	\$47.60
Universal, SFIC, G/H	23446347	23446347	\$17.50
AD/CO, SFIC, B/BDC	47258187	09-774	\$21.90
Corbin Russwin, KIL L-CO6	47258185	-	\$21.70

1. This part is shared with Schlage mechanical and defaults to the Schlage mechanical discount.

TAILPIECE KIT (FOR EXTERIOR ESCUTCHEON INTO EXIT DEVICE)			
Exit trim	New part number	Original part number	Price
Tailpiece kit (includes tailpiece, tailpiece guide, pine tree clip)	-	46929303	\$29.50

TAILPIECE KIT, 10-PIECE BULK PACK (Select by Chassis Type, Cylinder OEM, Cylinder Type, Cylinder Detail)			
Cylindrical	New part number	Original part number	Price
Schlage, KIL, P6/L - (Classic Cylinders)	09-418	09-418	\$20.00
Schlage, KIL, P6/L - (Everest/Primus/Modular Cylinders)	09-417	09-417	\$20.00
Falcon, KIL, P6/L	23790611	23790611	\$34.00
Mortise	New part number	Original part number	Price
Schlage, KIL, P6/L - (Classic Cylinders)	09-418	46928768	\$20.00
Schlage, KIL, P6/L - (Everest/Primus/Modular Cylinders)	09-417	46928776	\$20.00
Falcon, KIL, P6/L	23790611	-	\$34.00
Exit	New part number	Original part number	Price
Schlage, KIL, P6/L - (Classic Cylinders)	09-418	46928768	\$20.00
Schlage, KIL, P6/L - (Everest/Primus/Modular Cylinders)	09-417	46928776	\$20.00
Falcon, KIL, P6/L	23790611	-	\$34.00

CYLINDER (Select by Chassis Type, Cylinder Mechanism, Cylinder Type, Cylinder Detail)			
Cylindrical	New part number	Original part number	Price
Classic, KIL, P6 - (Only ATH, 8AT Lever Styles) ²	-	23-013 ²	\$92.00
Classic, FSIC, R (Open)	-	23-030	\$105.00
Classic, FSIC, R (Restricted)	-	23-030	\$134.00
Primus, KIL, P6 - (Only ATH, 8AT Lever Styles)	-	20-750	\$199.00

2. This part is shared with Schlage mechanical and defaults to the Schlage mechanical discount.

PARTS AND ACCESSORIES

CYLINDER (Select by Chassis Type, Cylinder Mechanism, Cylinder Type, Cylinder Detail)			
Cylindrical (continued)	New part number	Original part number	Price
Primus, FSIC, R	-	20-740	\$212.00
Primus UL, KIL, P6 - (Only ATH, 8AT Lever Styles)	-	20-550	\$266.00
Primus XP, KIL, P6 - (Only ATH, 8AT Lever Styles)	-	20-750-XP	\$199.00
Primus XP, FSIC, R	-	20-740-XP	\$212.00
Primus UL XP, KIL, P6 - (Only ATH, 8AT Lever Styles)	-	20-550-XP	\$266.00
Mortise	New part number	Original part number	Price
Classic, KIL, P6 - (Except ATH, 8AT Lever Styles) (Open) ²	-	23-118 ²	\$92.00
Classic, KIL, P6 - (Except ATH, 8AT Lever Styles) (Restricted)	-	23-118	\$121.00
Classic, FSIC, R (Open)	-	23-030	\$105.00
Primus, KIL, P6 - (Except ATH, 8AT Lever Styles)	-	20-854	\$199.00
Primus, FSIC, R	-	20-740	\$212.00
Primus UL, KIL, P6 - (Except ATH, 8AT Lever Styles)	-	20-554	\$266.00
Primus XP, KIL, P6 - (Except ATH, 8AT Lever Styles)	-	20-854-XP	\$199.00
Primus XP, FSIC, R	-	20-740-XP	\$212.00
Primus UL XP, KIL, P6 - (Except ATH, 8AT Lever Styles)	-	20-554-XP	\$266.00
Exit	New part number	Original part number	Price
Classic, KIL, P6 - (Except ATH, 8AT Lever Styles) (Open) ²	-	23-118 ²	\$92.00
Classic, KIL, P6 - (Except ATH, 8AT Lever Styles) (Restricted)	-	23-118	\$121.00
Classic, KIL, P6 - (Only ATH, 8AT Lever Styles) ²	-	23-013 ²	\$92.00
Classic, FSIC, R (Open)	-	23-030	\$105.00
Classic, FSIC, R (Restricted)	-	23-030	\$134.00
Primus, KIL, P6 - (Except ATH, 8AT Lever Styles)	-	20-854	\$199.00
Primus, KIL, P6 - (Only ATH, 8AT Lever Styles)	-	20-750	\$199.00
Primus, FSIC, R	-	20-740	\$212.00
Primus UL, KIL, P6 - (Except ATH, 8AT Lever Styles)	-	20-554	\$230.00
Primus UL, KIL, P6 - (Only ATH, 8AT Lever Styles)	-	20-550	\$266.00
Primus XP, KIL, P6 - (Except ATH, 8AT Lever Styles)	-	20-854-XP	\$199.00
Primus XP, KIL, P6 - (Only ATH, 8AT Lever Styles)	-	20-750-XP	\$199.00
Primus XP, FSIC, R	-	20-740-XP	\$212.00
Primus UL XP, KIL, P6 - (Except ATH, 8AT Lever Styles)	-	20-554-XP	\$266.00
Primus UL XP, KIL, P6 - (Only ATH, 8AT Lever Styles)	-	20-550-XP	\$266.00

2. This part is shared with Schlage mechanical and defaults to the Schlage mechanical discount.

LATCHES													
Available finishes				605	606	612	613	619	622	625	626	643e	626AM
				▪	▪	▪	N/A	▪	N/A	▪	▪	▪	N/A
DEADLATCHES													
Description	Backset	Specify		Price each									
		Part number	Finish										
Square corner, 1-1/8" x 2-1/4"	2-3/4"	13-247	.[Finish]	\$125.00									
Anti-friction fire door latch, Square corner, 1-1/8" x 2-1/4", 3/4" throw	2-3/4"	14-049	.[Finish]	\$525.00									
Square corner, 1-1/8" x 2-1/4"	2-3/8"	14-051	.[Finish]	\$171.00									
Square corner, 1-1/8" x 2-1/4"	3-3/4"	14-050	.[Finish]	\$156.00									

PARTS AND ACCESSORIES

INTERIOR LEVER (CLOSED)				Available finishes									
				605	606	612	613	619	622	625	626	643e	626AM
				▪	▪	▪	N/A	▪	N/A	▪	▪	▪	▪
Description	Style options	New part number	Original part number	Specify		Price							
				Lever design	Finish								
Inside Lever, Closed	ATH (Athens) RHO (Rhodes) SPA (Sparta) TLR (Tubular)	03-230	03-030	.[Lever]	.[Finish]	\$196.00							

EXTERIOR LEVER (LESS CYLINDER) (Select by Chassis Type, Cylinder OEM, Cylinder Type, Cylinder Detail)				Available finishes									
				605	606	612	613	619	622	625	626	643e	626AM
				▪	▪	▪	N/A	▪	N/A	▪	▪	▪	▪

Cylindrical						
Description	New part number	Original part number	Specify		Price	
			Lever design	Finish		
Schlage, KIL, P6/L	03-231	03-031	.[Lever]	.[Finish]	\$196.00	
Schlage, FSIC, R/J	03-232	03-032	.[Lever]	.[Finish]	\$196.00	
Schlage, SFIC, G/B	03-200	03-000	.[Lever]	.[Finish]	\$263.00	
Falcon, KIL, L-FA7 (7-pin)	03-280	23779739	.RHO	.[Finish]	\$214.00	
		23779762	.SPA	.[Finish]	\$214.00	
		23779747	.8RO	.[Finish]	\$283.00	
		23779770	.8SP	.[Finish]	\$283.00	
Corbin Russwin, FSIC, J-CO6 (6-pin)	03-266	03-066	.[Lever]	.[Finish]	\$361.00	
Corbin Russwin, FSIC, J-CO7 (7-pin)	03-235	23854524	.RHO	.[Finish]	\$361.00	
		23854540	.SPA	.[Finish]	\$361.00	
		23854565	.TLR	.[Finish]	\$361.00	
		23854532	.8RO	.[Finish]	\$428.00	
		23854557	.8SP	.[Finish]	\$428.00	
		23854573	.8TR	.[Finish]	\$428.00	
Sargent, KIL, L-SAR (6-pin)	03-244	03-044	.[Lever]	.[Finish]	\$361.00	
Sargent, FSIC, J-SAR (6-pin)	03-277	03-077	.[Lever]	.[Finish]	\$361.00	
Medeco, FSIC, J-MED (6-pin)	03-237	09-388	.[Lever]	.[Finish]	\$361.00	
Yale, FSIC, J-YA6 (6-pin)	03-255	09-355	.[Lever]	.[Finish]	\$361.00	
Yale, FSIC, J-YA7 (7-pin)	03-236	09-399	.[Lever]	.[Finish]	\$361.00	
Corbin Russwin, KIL, L-CO6 (6-pin)	03-234	-	.[Lever]	.[Finish]	\$361.00	
New lever options (Cylindrical)						
Boardwalk - Closed	47258044	-	.BRK	.[Finish]	\$199.00	
Boardwalk - J	47258052	-	.BRK	.[Finish]	\$199.00	
Boardwalk - P6/L	47258048	-	.BRK	.[Finish]	\$199.00	
Boardwalk - BDC/B/G/H	47258040	-	.BRK	.[Finish]	\$199.00	
Broadway - Closed	47258043	-	.BRW	.[Finish]	\$199.00	
Broadway - J	47258051	-	.BRW	.[Finish]	\$199.00	
Broadway - P6/L	47258047	-	.BRW	.[Finish]	\$199.00	
Broadway - BDC/B/G/H	47258039	-	.BRW	.[Finish]	\$199.00	
Latitude - Closed	47258045	-	.LAT	.[Finish]	\$199.00	
Latitude - J	47258053	-	.LAT	.[Finish]	\$199.00	
Latitude - P6/L	47258049	-	.LAT	.[Finish]	\$199.00	
Latitude - BDC/B/G/H	47258041	-	.LAT	.[Finish]	\$199.00	
Longitude - Closed	47258046	-	.LON	.[Finish]	\$199.00	
Longitude - J	47258054	-	.LON	.[Finish]	\$199.00	
Longitude - P6/L	47258050	-	.LON	.[Finish]	\$199.00	
Longitude - BDC/B/G/H	47258042	-	.LON	.[Finish]	\$199.00	
Boardwalk (Tactile) - Closed	47260554	-	.8BK	.[Finish]	\$267.00	
Boardwalk (Tactile) - J	47260546	-	.8BK	.[Finish]	\$267.00	
Boardwalk (Tactile) - P6/L	47260550	-	.8BK	.[Finish]	\$267.00	

CREDENTIALS
 READERS
 READER CONTROLLERS
 MULTI-FAMILY
 ENGAGE
 AD SERIES
 CO SERIES
 ELECTROMAGNETIC LOCKS
 POWER SUPPLIES
 VON DUPRIN ACCESS CONTROL
 SYSTEM ACC
 MISC

PARTS AND ACCESSORIES

EXTERIOR LEVER (LESS CYLINDER) (Select by Chassis Type, Cylinder OEM, Cylinder Type, Cylinder Detail)			Available finishes									
			605	606	612	613	619	622	625	626	643e	626AM
			▪	▪	▪	N/A	▪	N/A	▪	▪	▪	▪
New lever options (Cylindrical) (continued)												
Description	New part number	Original part number	Specify		Price							
			Lever design	Finish								
Boardwalk (Tactile) - BDC/B/G/H	47260538	-	.8BK	.[Finish]	\$267.00							
Broadway (Tactile) - Closed	47260553	-	.8BY	.[Finish]	\$267.00							
Broadway (Tactile) - J	47260545	-	.8BY	.[Finish]	\$267.00							
Broadway (Tactile) - P6/L	47260549	-	.8BY	.[Finish]	\$267.00							
Broadway (Tactile) - BDC/B/G/H	47260537	-	.8BY	.[Finish]	\$267.00							
Latitude (Tactile) - Closed	47260555	-	.8LT	.[Finish]	\$267.00							
Latitude (Tactile) - J	47260547	-	.8LT	.[Finish]	\$267.00							
Latitude (Tactile) - P6/L	47260551	-	.8LT	.[Finish]	\$267.00							
Latitude (Tactile) - BDC/B/G/H	47260539	-	.8LT	.[Finish]	\$267.00							
Longitude (Tactile) - Closed	47260556	-	.8LN	.[Finish]	\$267.00							
Longitude (Tactile) - J	47260548	-	.8LN	.[Finish]	\$267.00							
Longitude (Tactile) - P6/L	47260552	-	.8LN	.[Finish]	\$267.00							
Longitude (Tactile) - BDC/B/G/H	47260540	-	.8LN	.[Finish]	\$267.00							
Mortise												
Schlage, KIL, P6/L	03-231	09-331	.[Lever]	.[Finish]	\$196.00							
Schlage, FSIC, RD/J	03-232	09-332	.[Lever]	.[Finish]	\$196.00							
Schlage, SFIC, GD/BD	03-200	03-000	.[Lever]	.[Finish]	\$263.00							
Falcon, KIL, L-FA7 (7-pin)	03-280	09-331	.[Lever]	.[Finish]	\$214.00							
Corbin Russwin, FSIC, J-CO6 (6-pin)	03-266	09-366	.[Lever]	.[Finish]	\$361.00							
Corbin Russwin, FSIC, J-CO7 (7-pin)	03-235	09-366	.[Lever]	.[Finish]	\$361.00							
Sargent, KIL, L-SAR (6-pin)	03-244	09-344	.[Lever]	.[Finish]	\$361.00							
Sargent, FSIC, J-SAR (6-pin)	03-277	09-377	.[Lever]	.[Finish]	\$361.00							
Medeco, FSIC, J-MED (6-pin)	03-237	09-388	.[Lever]	.[Finish]	\$361.00							
Yale, FSIC, J-YA6 (6-pin)	03-255	09-355	.[Lever]	.[Finish]	\$361.00							
Yale, FSIC, J-YA7 (7-pin)	03-236	09-399	.[Lever]	.[Finish]	\$361.00							
Corbin Russwin, KIL, L-CO6 (6-pin)	03-234	-	.[Lever]	.[Finish]	\$361.00							
New lever options (Mortise)												
Boardwalk - Closed	47258044	-	.BRK	.[Finish]	\$199.00							
Boardwalk - J	47258052	-	.BRK	.[Finish]	\$199.00							
Boardwalk - P6/L	47258048	-	.BRK	.[Finish]	\$199.00							
Boardwalk - BDC/B/G/H	47258040	-	.BRK	.[Finish]	\$199.00							
Broadway - Closed	47258043	-	.BRW	.[Finish]	\$199.00							
Broadway - J	47258051	-	.BRW	.[Finish]	\$199.00							
Broadway - P6/L	47258047	-	.BRW	.[Finish]	\$199.00							
Broadway - BDC/B/G/H	47258039	-	.BRW	.[Finish]	\$199.00							
Latitude - Closed	47258045	-	.LAT	.[Finish]	\$199.00							
Latitude - J	47258053	-	.LAT	.[Finish]	\$199.00							
Latitude - P6/L	47258049	-	.LAT	.[Finish]	\$199.00							
Latitude - BDC/B/G/H	47258041	-	.LAT	.[Finish]	\$199.00							
Longitude - Closed	47258046	-	.LON	.[Finish]	\$199.00							
Longitude - J	47258054	-	.LON	.[Finish]	\$199.00							
Longitude - P6/L	47258050	-	.LON	.[Finish]	\$199.00							
Longitude - BDC/B/G/H	47258042	-	.LON	.[Finish]	\$199.00							
Boardwalk (Tactile) - Closed	47260554	-	.8BK	.[Finish]	\$267.00							
Boardwalk (Tactile) - J	47260546	-	.8BK	.[Finish]	\$267.00							
Boardwalk (Tactile) - P6/L	47260550	-	.8BK	.[Finish]	\$267.00							
Boardwalk (Tactile) - BDC/B/G/H	47260538	-	.8BK	.[Finish]	\$267.00							
Broadway (Tactile) - Closed	47260553	-	.8BY	.[Finish]	\$267.00							
Broadway (Tactile) - J	47260545	-	.8BY	.[Finish]	\$267.00							
Broadway (Tactile) - P6/L	47260549	-	.8BY	.[Finish]	\$267.00							

NETWORKED LOCKS

STANDALONE LOCKS

PARTS

PARTS AND ACCESSORIES

EXTERIOR LEVER (LESS CYLINDER) (Select by Chassis Type, Cylinder OEM, Cylinder Type, Cylinder Detail)			Available finishes									
			605	606	612	613	619	622	625	626	643e	626AM
New lever options (Mortise) (continued)			▪	▪	▪	N/A	▪	N/A	▪	▪	▪	▪
Description	New part number	Original part number	Specify		Price							
			Lever design	Finish								
Broadway (Tactile) - BDC/B/G/H	47260537	-	.8BY	.[Finish]	\$267.00							
Latitude (Tactile) - Closed	47260555	-	.8LT	.[Finish]	\$267.00							
Latitude (Tactile) - J	47260547	-	.8LT	.[Finish]	\$267.00							
Latitude (Tactile) - P6/L	47260551	-	.8LT	.[Finish]	\$267.00							
Latitude (Tactile) - BDC/B/G/H	47260539	-	.8LT	.[Finish]	\$267.00							
Longitude (Tactile) - Closed	47260556	-	.8LN	.[Finish]	\$267.00							
Longitude (Tactile) - J	47260548	-	.8LN	.[Finish]	\$267.00							
Longitude (Tactile) - P6/L	47260552	-	.8LN	.[Finish]	\$267.00							
Longitude (Tactile) - BDC/B/G/H	47260540	-	.8LN	.[Finish]	\$267.00							
Exit												
Schlage, KIL, P6/L	03-231	03-331	.[Lever]	.[Finish]	\$196.00							
Schlage, FSIC, R/J	03-232	03-332	.[Lever]	.[Finish]	\$196.00							
Schlage, SFIC, G/B	03-200	03-300	.[Lever]	.[Finish]	\$263.00							
Falcon, KIL, L-FA7 (7-pin)	03-280	03-331	.[Lever]	.[Finish]	\$214.00							
Corbin Russwin, FSIC, J-CO6 (6-pin)	03-266	03-366	.[Lever]	.[Finish]	\$361.00							
Corbin Russwin, FSIC, J-CO7 (7-pin)	03-235	03-366	.[Lever]	.[Finish]	\$361.00							
Sargent, KIL, L-SAR (6-pin)	03-244	03-344	.[Lever]	.[Finish]	\$361.00							
Sargent, FSIC, J-SAR (6-pin)	03-277	03-377	.[Lever]	.[Finish]	\$361.00							
Medeco, FSIC, J-MED (6-pin)	03-237	03-388	.[Lever]	.[Finish]	\$361.00							
Yale, FSIC, J-YA6 (6-pin)	03-255	03-355	.[Lever]	.[Finish]	\$361.00							
Yale, FSIC, J-YA7 (7-pin)	03-236	03-399	.[Lever]	.[Finish]	\$361.00							
Corbin Russwin, KIL, L-CO6 (6-pin)	03-234	-	.[Lever]	.[Finish]	\$361.00							
New lever options (Exit)												
Boardwalk - Closed	47258044	-	.BRK	.[Finish]	\$199.00							
Boardwalk - J	47258052	-	.BRK	.[Finish]	\$199.00							
Boardwalk - P6/L	47258048	-	.BRK	.[Finish]	\$199.00							
Boardwalk - BDC/B/G/H	47258040	-	.BRK	.[Finish]	\$199.00							
Broadway - Closed	47258043	-	.BRW	.[Finish]	\$199.00							
Broadway - J	47258051	-	.BRW	.[Finish]	\$199.00							
Broadway - P6/L	47258047	-	.BRW	.[Finish]	\$199.00							
Broadway - BDC/B/G/H	47258039	-	.BRW	.[Finish]	\$199.00							
Latitude - Closed	47258045	-	.LAT	.[Finish]	\$199.00							
Latitude - J	47258053	-	.LAT	.[Finish]	\$199.00							
Latitude - P6/L	47258049	-	.LAT	.[Finish]	\$199.00							
Latitude - BDC/B/G/H	47258041	-	.LAT	.[Finish]	\$199.00							
Longitude - Closed	47258046	-	.LON	.[Finish]	\$199.00							
Longitude - J	47258054	-	.LON	.[Finish]	\$199.00							
Longitude - P6/L	47258050	-	.LON	.[Finish]	\$199.00							
Longitude - BDC/B/G/H	47258042	-	.LON	.[Finish]	\$199.00							
Boardwalk (Tactile) - Closed	47260554	-	.8BK	.[Finish]	\$267.00							
Boardwalk (Tactile) - J	47260546	-	.8BK	.[Finish]	\$267.00							
Boardwalk (Tactile) - P6/L	47260550	-	.8BK	.[Finish]	\$267.00							
Boardwalk (Tactile) - BDC/B/G/H	47260538	-	.8BK	.[Finish]	\$267.00							
Broadway (Tactile) - Closed	47260553	-	.8BY	.[Finish]	\$267.00							
Broadway (Tactile) - J	47260545	-	.8BY	.[Finish]	\$267.00							
Broadway (Tactile) - P6/L	47260549	-	.8BY	.[Finish]	\$267.00							
Broadway (Tactile) - BDC/B/G/H	47260537	-	.8BY	.[Finish]	\$267.00							
Latitude (Tactile) - Closed	47260555	-	.8LT	.[Finish]	\$267.00							
Latitude (Tactile) - J	47260547	-	.8LT	.[Finish]	\$267.00							
Latitude (Tactile) - P6/L	47260551	-	.8LT	.[Finish]	\$267.00							

CREDENTIALS
 READERS
 READER CONTROLLERS
 MULTI-FAMILY
 ENGAGE
 AD SERIES
 CO SERIES
 ELECTROMAGNETIC LOCKS
 POWER SUPPLIES
 VON DUPRIN ACCESS CONTROL
 SYSTEM ACC
 MISC

PARTS AND ACCESSORIES

EXTERIOR LEVER (LESS CYLINDER) (Select by Chassis Type, Cylinder OEM, Cylinder Type, Cylinder Detail)	Available finishes									
	605	606	612	613	619	622	625	626	643e	626AM
	▪	▪	▪	N/A	▪	N/A	▪	▪	▪	▪

New lever options (Exit) (continued)					
Description	New part number	Original part number	Specify		Price
			Lever design	Finish	
Latitude (Tactile) - BDC/B/G/H	47260539	-	.8LT	.[Finish]	\$267.00
Longitude (Tactile) - Closed	47260556	-	.8LN	.[Finish]	\$267.00
Longitude (Tactile) - J	47260548	-	.8LN	.[Finish]	\$267.00
Longitude (Tactile) - P6/L	47260552	-	.8LN	.[Finish]	\$267.00
Longitude (Tactile) - BDC/B/G/H	47260540	-	.8LN	.[Finish]	\$267.00

EXTERIOR LEVER (LESS CYLINDER), 10-PIECE BULK PACK (Select by Chassis Type, Cylinder OEM, Cylinder Type, Cylinder Detail)	Available finishes									
	605	606	612	613	619	622	625	626	643e	626AM
	▪	▪	▪	N/A	▪	N/A	▪	▪	▪	▪

Cylindrical					
Description	New part number	Original part number	Specify		Price
			Lever design	Finish	
Schlage, KIL, P6/L ¹	K103-681	K103-031	.[Lever]	.[Finish]	\$1,553.00
Schlage, FSIC, R/J ¹	K103-682	K103-032	.[Lever]	.[Finish]	\$1,849.00
Schlage, SFIC, G/B ¹	K103-680	K103-000	.[Lever]	.[Finish]	\$1,849.00
Corbin Russwin, FSIC, J-CO6 (6-pin) ¹	K103-684	K103-066	.[Lever]	.[Finish]	\$2,880.00
Sargent, KIL, L-SAR (6-pin) ¹	K103-683	K103-044	.[Lever]	.[Finish]	\$3,685.00
Sargent, FSIC, J-SAR (6-pin) ¹	K103-685	K103-077	.[Lever]	.[Finish]	\$3,646.00
Medeco, FSIC, J-MED (6-pin)	K103-687	K109-388	.[Lever]	.[Finish]	\$3,689.00
Yale, FSIC, J-YA6 (6-pin) ¹	K103-686	K103-055	.[Lever]	.[Finish]	\$3,689.00
Yale, FSIC, J-YA7 (7-pin) ¹	K103-688	K109-399	.[Lever]	.[Finish]	\$3,689.00
Falcon, KIL, L-FA7 (7-pin)	K103-689	-	.[Lever]	.[Finish]	\$2,965.00
Corbin Russwin, FSIC, J-CO7 (7-pin)	K103-690	23991086	.RHO	.[Finish]	\$2,965.00
		23991094	.SPA	.[Finish]	\$2,965.00
		23991102	.TLR	.[Finish]	\$2,860.00
		23991110	.8RO	.[Finish]	\$3,653.00
		23991128	.8SP	.[Finish]	\$3,653.00
		23991136	.8TR	.[Finish]	\$3,653.00

Mortise					
Description	New part number	Original part number	Specify		Price
			Lever design	Finish	
Schlage, KIL, P6/L ¹	K103-681	K109-331	.[Lever]	.[Finish]	\$1,553.00
Schlage, FSIC, R/J ¹	K103-682	K109-332	.[Lever]	.[Finish]	\$1,849.00
Schlage, SFIC, G/B ¹	K103-680	K103-000	.[Lever]	.[Finish]	\$1,849.00
Corbin Russwin, FSIC, J-CO6 (6-pin) ¹	K103-684	K109-366	.[Lever]	.[Finish]	\$2,880.00
Sargent, KIL, L-SAR (6-pin) ¹	K103-683	K109-344	.[Lever]	.[Finish]	\$3,685.00
Sargent, FSIC, J-SAR (6-pin) ¹	K103-685	K109-377	.[Lever]	.[Finish]	\$3,646.00
Medeco, FSIC, J-MED (6-pin)	K103-687	K109-388	.[Lever]	.[Finish]	\$3,689.00
Yale, FSIC, J-YA6 (6-pin) ¹	K103-686	K109-355	.[Lever]	.[Finish]	\$3,689.00
Yale, FSIC, J-YA7 (7-pin) ¹	K103-688	K109-399	.[Lever]	.[Finish]	\$3,689.00
Falcon, KIL, L-FA7 (7-pin)	K103-689	K109-331	.[Lever]	.[Finish]	\$2,965.00
Corbin Russwin, FSIC, J-CO7 (7-pin)	K103-690	K109-366	.[Lever]	.[Finish]	\$2,965.00

Exit					
Description	New part number	Original part number	Specify		Price
			Lever design	Finish	
Schlage, KIL, P6/L ¹	K103-681	K103-331	.[Lever]	.[Finish]	\$1,553.00
Schlage, FSIC, R/J ¹	K103-682	K103-332	.[Lever]	.[Finish]	\$1,849.00
Corbin Russwin, FSIC, J-CO6 (6-pin)	K103-684	K103-366	.[Lever]	.[Finish]	\$2,880.00
Corbin Russwin, FSIC, J-CO7 (7-pin)	K103-690	K103-366	.[Lever]	.[Finish]	\$2,965.00
Sargent, KIL, L-SAR (6-pin) ¹	K103-683	K103-344	.[Lever]	.[Finish]	\$3,685.00
Schlage, SFIC, G/B ¹	K103-680	K103-000	.[Lever]	.[Finish]	\$1,849.00
Falcon, KIL, L-FA7 (7-pin)	K103-689	K103-331	.[Lever]	.[Finish]	\$2,965.00
Sargent, FSIC, J-SAR (6-pin) ¹	K103-685	K103-377	.[Lever]	.[Finish]	\$3,646.00

1. This part is shared with Schlage mechanical and defaults to the Schlage mechanical discount.

PARTS AND ACCESSORIES

EXTERIOR LEVER (LESS CYLINDER), 10-PIECE BULK PACK (Select by Chassis Type, Cylinder OEM, Cylinder Type, Cylinder Detail)			Available finishes									
			605	606	612	613	619	622	625	626	643e	626AM
Exit (continued)			▪	▪	▪	N/A	▪	N/A	▪	▪	▪	▪
Description	New part number	Original part number	Specify		Price							
			Lever design	Finish								
Medeco, FSIC, J-MED (6-pin)	K103-687	K103-388	.[Lever]	.[Finish]	\$3,689.00							
Yale, FSIC, J-YA6 (6-pin) ¹	K103-686	K103-355	.[Lever]	.[Finish]	\$3,689.00							
Yale, FSIC, J-YA7 (7-pin) ¹	K103-688	K103-399	.[Lever]	.[Finish]	\$3,689.00							

1. This part is shared with Schlage mechanical and defaults to the Schlage mechanical discount.

LOCK RETRACTOR (Select by Chassis Type, Chassis Thickness)		
Cylindrical		
Description	Specify	Price
Retractor	46928800	\$497.00
Mortise case		
1-1/16" Narrow - (door thicknesses 1-3/8" to 1-5/8")	46928818	\$637.00
1-1/4" Standard - (door thicknesses 1-3/4" to 2-3/4")	46928826	\$637.00
Mortise case with deadbolt		
1-1/16" Narrow - (door thicknesses 1-3/8" to 1-5/8")	46928834	\$805.00
1-1/4" Standard - (door thicknesses 1-3/4" to 2-3/4")	46928842	\$805.00

SPINDLE AND HUB KIT (Select by Chassis Type)		
Exit		
Description	Specify	Price
Exit spindle and hub kit (Includes spindle, spindle cover, spindle hub, tailpiece, twisted tailpiece, tailpiece spring, pine tree clip, screw)	46929295	\$61.70

SPINDLE SPRING		
Description	Specify	Price
Inside spindle spring (25 pack)	47256978	\$114.50

DEADBOLT THUMB TURN ASSEMBLY (WITH E-CLIP)			Available finishes									
			605	606	612	613	619	622	625	626	643e	626AM
			▪	▪	▪	N/A	▪	N/A	▪	▪	▪	▪
Description	Specify		Price									
	Part number	Finish										
Deadbolt thumb turn assembly (with E-clip)	46929113	.[Finish]	\$49.80									

PARTS AND ACCESSORIES

The Schlage AD-993 internal push button (IPB) retrofit kit relocates the push button from the interior escutcheon of the lock to the exit device to meet the specific needs of California Building Code accessibility standards, Section 11B-404.2.7. This retrofit kit is available for the AD-993 with Von Duprin 98/99 exit devices with the following options:



- Rim, Concealed Vertical Rod (CVR) / Concealed Vertical Cable (CVC), XP, Mortise, and Surface Vertical Rod (SVR) devices
- Right hand reverse (RHR) or Left-hand reverse (LHR) door handing

IPB RETROFIT KIT MODULE (Note: IPB Retrofit Kits will be handled and invoiced from Von Duprin Plant.)												
Description	Available Finishes							Specify			Price	
	605	606	619	625	626	643e	626AM	Part number	Handing	Finish		
Rim Exit (LH) - Stainless Steel			▪	▪	▪	▪	▪	47385857	.[LHR or RHR]	.[Finish]	\$742.00	
Rim Exit Devices (RH) - Stainless Steel			▪	▪	▪	▪	▪	47385858	.[LHR or RHR]	.[Finish]	\$742.00	
Rim Exit (LH) - Brass	▪	▪						47385865	.[LHR or RHR]	.[Finish]	\$742.00	
Rim Exit (RH) - Brass	▪	▪						47385866	.[LHR or RHR]	.[Finish]	\$742.00	
Surface Vertical Rods (SVR) (LH) - Stainless Steel				▪	▪	▪	▪	47385859	.[LHR or RHR]	.[Finish]	\$742.00	
Surface Vertical Rods (SVR) (RH) - Stainless Steel				▪	▪	▪	▪	47385860	.[LHR or RHR]	.[Finish]	\$742.00	
Surface Vertical Rods (SVR) (LH) - Brass	▪	▪	▪					47385867	.[LHR or RHR]	.[Finish]	\$742.00	
Surface Vertical Rods (SVR) (RH) - Brass	▪	▪	▪					47385868	.[LHR or RHR]	.[Finish]	\$742.00	
CVR / CVC (LH) - Stainless Steel				▪	▪	▪	▪	47385861	.[LHR or RHR]	.[Finish]	\$742.00	
CVR / CVC (RH) - Stainless Steel				▪	▪	▪	▪	47385862	.[LHR or RHR]	.[Finish]	\$742.00	
CVR / CVC (LH) - Brass	▪	▪	▪					47385869	.[LHR or RHR]	.[Finish]	\$742.00	
CVR / CVC (RH) - Brass	▪	▪	▪					47385870	.[LHR or RHR]	.[Finish]	\$742.00	
MS (LH) - Brass	▪	▪	▪					47385871	.[LHR or RHR]	.[Finish]	\$742.00	
MS (RH) - Brass	▪	▪	▪					47385872	.[LHR or RHR]	.[Finish]	\$742.00	
MS (LH) - Stainless Steel				▪	▪	▪	▪	47455861	.[LHR or RHR]	.[Finish]	\$742.00	
MS (RH) - Stainless Steel				▪	▪	▪	▪	47455862	.[LHR or RHR]	.[Finish]	\$742.00	
XP99/98 (LH)	▪	▪	▪	▪	▪	▪	▪	47385863	.[LHR or RHR]	.[Finish]	\$742.00	
XP99/98 (RH)	▪	▪	▪	▪	▪	▪	▪	47385864	.[LHR or RHR]	.[Finish]	\$742.00	

MORTISE ARMOR FRONT (Select by Width, Door Thickness)																
09-663	09-666	09-669	09-672													
Available finishes							605	606	612	613	619	622	625	626	643e	626AM
							▪	▪	▪	N/A	▪	N/A	▪	▪	▪	▪
1-1/4" Wide (Standard armor size for 1-3/4" and larger door thicknesses)																
Description	Specify		Price													
	Part number	Finish														
Latch x auxiliary latch ¹	09-663	.[Finish]	\$53.00													
Latch x auxiliary latch x deadbolt ¹	09-666	.[Finish]	\$53.00													
1-1/16" Wide (armor size for doors thinner than 1-3/4", including 1-3/8" doors)																
Description	Specify		Price													
	Part number	Finish														
Latch x auxiliary latch ¹	09-669	.[Finish]	\$53.00													
Latch x auxiliary latch x deadbolt ¹	09-672	.[Finish]	\$53.00													

1. This part is shared with Schlage mechanical and defaults to the Schlage mechanical discount.
 2. Use with fire door latch.

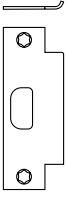
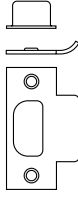
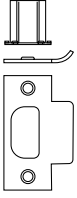
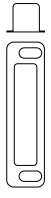
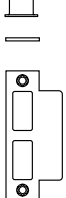
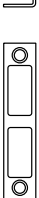
PARTS AND ACCESSORIES

STRIKE PLATE (Select by Chassis Type)						
10-025 	10-013 	10-016 	K510-066 	10-072 	10-075 	37-015 
Available finishes						605 606 612 613 619 622 625 626 643e 626AM ▪ ▪ ▪ N/A ▪ N/A ▪ ▪ ▪ ▪
Cylindrical						
Description	Default lip length	Specify			Price	
		Part number	Finish	Lip length		
1-1/4" x 4-7/8" ANSI, no box ¹	1-3/16"	10-025-1316	[Finish]	.LIP1-3/16	\$21.80	
1-1/4" x 4-7/8" ANSI, no box ¹	1-3/8"	10-025-138	[Finish]	.LIP1-3/8	\$62.60	
1-1/4" x 4-7/8" ANSI, no box ¹	1-1/2"	10-025-112	[Finish]	.LIP1-1/2	\$62.60	
1-1/8" x 2-3/4" square corner, T-strike, box ¹	1-1/8"	10-013-118	[Finish]	.LIP1-1/8	\$21.80	
1-1/8" x 2-3/4" square corner, T-strike, box ¹	1-1/2"	10-013-112	[Finish]	.LIP1-1/2	\$21.80	
1-1/8" x 2-3/4" square corner, T-strike, deep box ^{1, 2}	1-1/8"	10-016	[Finish]	.LIP1-1/8	\$21.80	
Box for ANSI strike (finish not applicable) ¹	-	K510-066	-	-	\$9.70	
1-1/4" x 4-7/8" ANSI, no box ¹	1-3/4"	XQ07-351-134	[Finish]	.LIP1-3/4	\$308.00	
1-1/8" x 2-3/4" square corner, T-strike, box ¹	1-3/4"	XQ03-494-134	[Finish]	.LIP1-3/4	\$88.00	
Mortise Deadbolt						
Description	Default lip length	Specify			Price	
		Part number	Finish	Lip length		
1-1/4" x 4-7/8" square corner, box (standard with Lip at 1-3/16", 1", 1-1/2", 1-3/4", or 2") ¹	1-3/16"	10-072-1316	[Finish]	.LIP1-3/16	\$32.00	
1-1/4" x 4-7/8" square corner, box (specify lip length [xx] as 1" or 1-1/2") ¹	1-3/16"	10-072-xx	[Finish]	.[Lip length]	\$32.00	
1-1/4" x 4-7/8" square corner, box (specify lip length [xx] as 1-3/4", 1" or 2") ¹	1-3/16"	10-072-xx	[Finish]	.[Lip length]	\$82.00	
1/2" Rabbeted ¹	-	10-075	[Finish]	.[Lip length]	\$211.00	
Strike frame reinforcer (finish not applicable)	-	37-015	-	-	\$35.90	

1. This part is shared with Schlage mechanical and defaults to the Schlage mechanical discount.
2. Use with fire door latch.

INTERIOR SHIM PLATE (Select by Class)		
Description	Specify	Price
Interior shim plate, AD200/250/300 - (Device is 0.063" thick)	23458607	\$42.80
Interior shim plate, AD400 - (Device is 0.063" thick)	23458565	\$42.80

EXTERIOR SHIM PLATE		
Description	Specify	Price
Exterior shim plate - (Device is 0.063" thick)	23458599	\$33.40

DOOR POSITION SWITCH		
Description	Specify	Price
Door Position Switch	46929121	\$46.90

PARTS AND ACCESSORIES

DOOR THICKNESS KIT (Select by Chassis Type)			
Cylindrical			
Description	Specify		Price
	Part number	Door thickness	
1-3/8" Door thickness kit (includes baseplate screws, reader screws, spindles, spring, pin wrench, fire plate screw, shim plates, standoffs)	46929170-138	. []	\$243.00
1-1/2" Door thickness kit (includes baseplate screws, reader screws, spindles, spring, pin wrench, fire plate screw, shim plates, standoffs)	46929170-112	. []	\$172.80
1-5/8" Door thickness kit (includes baseplate screws, reader screws, spindles, spring, pin wrench, fire plate screw, shim plates, standoffs)	46929170-158	. []	\$124.00
Door thickness kit (includes baseplate screws, reader screws, spindles, spring, pin wrench, fire plate screw, shim plates, standoffs) ¹	46929170-XXX	. []	\$74.00
Mortise			
1-3/8" Door thickness kit (includes baseplate screws, reader screws, spindles, spring, pin wrench, fire plate screw, shim plates, standoffs)	46929178-138	. []	\$243.00
1-1/2" Door thickness kit (includes baseplate screws, reader screws, spindles, spring, pin wrench, fire plate screw, shim plates, standoffs)	46929178-112	. []	\$172.80
1-5/8" Door thickness kit (includes baseplate screws, reader screws, spindles, spring, pin wrench, fire plate screw, shim plates, standoffs)	46929178-158	. []	\$124.00
Door thickness kit (includes baseplate screws, reader screws, spindles, spring, pin wrench, fire plate screw, shim plates, standoffs) ¹	46929178-XXX	. []	\$74.00

1. Must specify door thickness: 1-3/4" to 2-3/4" in 1/8" increments.

DECORATIVE PLATE (Select by Size)		Available finishes									
		605 ²	606	612	613	619	622	625	626	643e ²	626AM
		▪ N/A N/A N/A N/A N/A N/A ▪ ▪ N/A									
Size	Description	Specify		Price							
		Part number	Finish								
1.5" x 3.25" x .105"	Decorative plate (with screws) - (Exit chassis)	23631823	.[Finish]	\$52.50							
1.7" x 3.5" x .075"	Decorative plate (with screws)	23760267	.[Finish]	\$38.50							
3.2" x 3.5" x .075"	Decorative plate (with screws)	23760283	.[Finish]	\$59.70							
6.0" x 3.5" x .075"	Decorative plate (with screws)	23760317	.[Finish]	\$90.80							
6.6" x 3.5" x .075"	Decorative plate (with screws)	23760325	.[Finish]	\$90.80							
8.0" x 3.5" x .075"	Decorative plate (with screws)	23760309	.[Finish]	\$92.90							
8.0" x 3.5" x .075"	Decorative plate (with screws and welded standoff)	23760291	.[Finish]	\$125.90							
10.5" x 3.5" x .075"	Decorative plate (no screws necessary) - (under lock) ³	23760259	.[Finish]	\$120.10							
12.0" x 3.5" x .075"	Decorative plate (no screws necessary) - (under lock) ³	23760275	.[Finish]	\$118.90							

2. 626 Satin Chrome finish standard. Please consult Customer Care for 605 Bright Brass or 643E Aged Bronze.

3. Please consider overall Door Thickness when ordering.

4. Single Decorative plate. Interior and Exterior Decorative plates may be required.

5. Decorative plates may have multiple applications. Please see AD Series Retrofit Template Overlay guide at www.schlage.com/support for more information.

PARTS AND ACCESSORIES

OFFLINE/HARDWIRED COMMUNICATION MODULE COVER (Select by Function)	Available finishes									
	605	606	612	613	619	622	625	626	643e	626AM
	▪	▪	▪	N/A	▪	N/A	▪	▪	▪	▪
Description	Specify		Price							
	Part number	Finish								
Offline communication module cover, cover (Includes communication module cover, cover screw, Torx® cover screw)	COM200C (23519168)	.[Finish]	See page 175							
Offline/hardwired communication module cover, indicator (Includes off-line/hardwired communication module cover with indicator, cover screw, Torx cover screw)	COM200L (23519184)	.[Finish]								
Offline/hardwired communication module cover, pushbutton (Includes offline/hardwired communication module cover with pushbutton, cover screw, Torx cover screw)	COM200P (23519176)	.[Finish]								

HARDWIRED UPGRADE KIT (Select by Function)	Available finishes									
	605	606	612	613	619	622	625	626	643e	626AM
	▪	▪	▪	N/A	▪	N/A	▪	▪	▪	▪
Description	Specify		Price							
	Part number	Finish								
Hardwired upgrade kit, indicator (Includes hardwired communication module, standoff, offline/hardwired communication module cover with indicator, cover screw, Torx® cover screw)	COM300L (46928909)	.[Finish]	See page 175							
Hardwired upgrade kit, pushbutton (Includes hardwired communication module, standoff, offline/hardwired communication module cover with pushbutton, cover screw, Torx cover screw)	COM300P (46928891)	.[Finish]								

HARDWIRED COMMUNICATION MODULE		
Description	Specify	Price
Hardwired communication module (with fasteners, jumpers)	46928958	\$369.00

WIRELESS UPGRADE KIT (Select by Function)	Available finishes									
	605	606	612	613	619	622	625	626	643e	626AM
	▪	▪	▪	N/A	▪	N/A	▪	▪	▪	▪
Description	Specify		Price							
	Part number	Finish								
Wireless upgrade kit, indicator (Includes wireless communication module, (2) standoffs, wireless communication module cover with indicator, cover screw, Torx® cover screw, wireless foil gasket)	COM400L (46928867)	.[Finish]	See page 175							
Wireless upgrade kit, pushbutton (Includes wireless communication module, (2) standoffs, wireless communication module cover with pushbutton, cover screw, Torx cover screw, wireless foil gasket)	COM400P (46928859)	.[Finish]								

WIRELESS COMMUNICATION MODULE COVER (Select by Function)	Available finishes									
	605	606	612	613	619	622	625	626	643e	626AM
	▪	▪	▪	N/A	▪	N/A	▪	▪	▪	▪
Description	Specify		Price							
	Part number	Finish								
Wireless communication module cover, indicator (with screws)	46928883	.[Finish]	\$49.00							
Wireless communication module cover, pushbutton (with screws)	46928875	.[Finish]	\$99.00							

WIRELESS COMMUNICATION MODULE		
Description	Specify	Price
Wireless communication module (with screws, standoffs)	46928941	\$497.00
Wireless communication module with antenna connector (with screws, standoffs)	23848385	\$538.00

PARTS AND ACCESSORIES

WIRELESS PARTS		
Description	Specify	Price
Wireless foil gasket	46928974	\$29.00
Terminal block kit – (Includes one power connector and ten I/O connectors) supports PIM400, PIB300, TK400, ECK400, GCK400 and WRI400	47250326	\$65.90

BATTERY HOLDER AND COVER KIT (Select by Battery Quantity)			
Description	Specify		Price
	Part number	Finish	
4AA Battery holder and cover kit (Includes 4AA battery holder with cable, 4AA battery strap, battery strap screws, 4AA battery cover, cover screw, Torx® cover screw)	4B (46929055)	[Finish]	\$83.20
8AA Battery holder and cover kit (Includes 8AA battery holder with cable, 8AA battery strap, battery strap screws, 8AA battery cover, cover screw, Torx cover screw)	8B (46929089)	[Finish]	\$153.70

BATTERY HOLDER KIT (Select by Battery Quantity)		
Description	Specify	Price
4AA Battery holder kit (Includes 4AA battery holder w/ cable, 4AA battery strap, battery strap screws)	46929063	\$35.90
8AA Battery holder kit (Includes 8AA battery holder w/ cable, 8AA battery strap, battery strap screws)	46929097	\$71.20

BATTERY PARTS			
Description	Specify		Price
	Part number	Finish	
4AA Battery cover (with screw)	4C (46929071)	[Finish]	\$47.60
8AA Battery cover (with screw)	8C (46929105)	[Finish]	\$83.70
Mylar protective sticker for 8 battery pack (package of 20)	47250305	-	\$214.10
AD Battery cable (package of 5)	47250320	-	\$34.00

BATTERY ¹ (Select by Battery Type)		
Description	Specify	Price
(4) AA Batteries	F206-488	\$16.00

1. Not for use with AD Series Locks.

INTERIOR COVER HARDWARE KIT	Available finishes										
	605	606	612	613	619	622	625	626	643e	626AM	
	▪	▪	▪	N/A	▪	N/A	▪	▪	▪	▪	
Description	Specify										Price
Interior cover hardware kit (Includes (2) wireless communication module cover screws, (1) hardwired communication module cover screw, (1) 4AA battery cover screw, (1) 8AA battery cover screw)	Part number	Finish									\$62.00
	46928966	[Finish]									

INTERIOR MAIN BOARD			
Description	Specify		Price
	Part number	Class	
Interior main board (with battery lead, coin cell battery, (2) screws)	46929048	[Class]	\$949.00

PARTS AND ACCESSORIES

TORX® TAMPER SCREW PACK (Select by Chassis Type)			
Chassis type	Description	Specify	Price
Cylindrical	Torx tamper screw pack	23538812	\$59.70
Mortise	Torx tamper screw pack	23538820	\$47.60
Exit	Torx tamper screw pack	23538838	\$58.10

WIRING HARNESS (INTERIOR MAIN BOARD TO EXTERIOR BOARD) (Select by Chassis Type)			
Chassis type	Description	Specify	Price
Cylindrical	Wiring harness (interior main board to exterior board)	46928727	\$76.00
Mortise	Wiring harness (interior main board to exterior board)	46928727	\$76.00
Exit	Wiring harness (interior main board to exterior board)	46928735	\$76.00
Exit	RX Adapter	23536774	\$71.20

REX SWITCH, LEAF SPRING AND SCREWS		
Description	Specify	Price
REX Switch, leaf spring and screws - (for CY and MS/MD only)	46929139	\$49.80

DRILL BIT (Same as Legacy)		
Description	Specify	Price
Drill Bit for 3/8" VIP/AD-300	P511472	\$1,177.00

REQUEST-TO-EXIT SWITCH KIT		
Description	Specify	Price
Von Duprin RX-LC (also called SI-LC or Von Duprin part number 050281)	RX-LC	\$482.00
(Warm) Keypad, base, keypad + proximity, AD, KIT	47269269	\$55.80
(Warm) Keypad, MSK, AD, KIT	47269271	\$55.80
(Warm) Keypad, base, keypad + mag reader, AD, KIT	47269273	\$55.80
(Warm) Keypad, base, keypad only module, AD, KIT	47269275	\$55.80
Inside push button, AD/CO	47269170	\$87.00
Mag reader head, AD	47269169	\$184.00

Please see Falcon Price Book for Falcon AE part number 650359.

Contents

CO Series Standalone | Overview198
CO Series Standalone | Functions201
CO Series Standalone | Readers.....202
CO Series Standalone | Styles203
CO Series Standalone | Configure a product204
 Cylinders 205
 Key systems206
 Handing.....206
 Battery.....206
 Backset and latchbolt (Cylindrical chassis).....207
 Mortise lock armor front (Mortise/Mortise deadbolt chassis)208
 Strike plates (Cylindrical chassis) 209
 Door dimensions 210
CO-100 Manually programmable..... 211
 Cylindrical.....211
 Mortise213
 Exit trim.....215
CO-200 Standalone..... 217
 Cylindrical..... 217
 Mortise/mortise deadbolt 219
 Exit trim.....221
CO-220 Classroom lockdown 223
 Cylindrical.....223
 Mortise225
 Exit trim.....227
CO-250 Standalone 229
 Cylindrical.....229
 Mortise/mortise deadbolt231
 Exit trim.....233
CO-993DT Non-functioning dummy exit trim..... 235
CT5000 Offline controller 237
CO Series | Accessories 239
CO Series | Parts 241

Finish codes and descriptions

BHMA code	Description
605	Bright brass
606	Satin brass
612	Satin bronze
619	Satin nickel
625	Bright chromium plated
626	Satin chrome
626AM	Satin stainless steel, antimicrobial
643e	Aged bronze

Customer service	Technical support
<ul style="list-style-type: none"> Order status Credit returns of non-defective products General sales questions <p>USA Allegion_Orders@allegion.com CAN Canada.CustomerService@allegion.com</p>	<ul style="list-style-type: none"> Technical questions/issues Returns of defective products Repairs <p>USA Electronic_Lock_TechProdSupport@allegion.com CAN Canada.TechServices@allegion.com</p>











How to order CO Series

	REQUIRED FIELDS				FACTORY DEFAULT AND OPTIONS										
	CO	200	CY	70	MS	SPA	626	P6	S123	RH	4B	13-247	10-025	134	BAA
1. Series															
2. Class															
100	Keypad programmable														
200	Rights on lock														
220	Classroom lockdown solution														
250	Rights on magnetic stripe credential														
3. Chassis															
CY	Cylindrical														
MS	Mortise														
MD	Mortise Deadbolt														
993R	Exit trim - Rim/CVR/CVC														
993S	Exit trim - SVR														
993M	Exit trim - Mortise														
993DT	Dummy Exit trim														
4. Function															
75	Classroom Security				70	Storeroom									
70	Office/Classroom				40	Privacy									
5. Reader															
KP	Keypad														
MSK	Magnetic stripe + Keypad (Swipe)														
MS	Magnetic stripe (Swipe)														
PRK	Proximity + Keypad														
PR	Proximity														
6. Lever*															
SPA	Sparta				ATH	Athens									
RHO	Rhodes				TLR	Tubular									
* To add tactile warning, use prefix 8. Example: 8SP															
7. Finish															
605	Bright Brass				625	Bright Chrome									
606	Satin Brass				626	Satin Chrome									
612	Satin Bronze				643e	Aged Bronze									
619	Satin Nickel				626AM	Satin Chrome (Antimicrobial Coating)									
8. Cylinder type															
P6	Schlage 6-pin Full Cylinder														
For options see individual Class/Chassis page															
9. Keyway type															
S123	Everest 29														
For options see individual Class/Chassis page															
10. Handing															
RH	Right handed				RHR	Right handed reverse									
LH	Left handed				LHR	Left handed reverse									
11. Battery holder															
4B	4AA Battery kit														
12. Backset & latch or Armor front															
13-247	2-3/4" Backset, deadlatch, square corner, 1-1/8" x 2-1/4" (Std. on CY Chassis)														
09-663	Armor front, 1-1/4" wide, square corner (Std. on MS Chassis)														
For options see individual Class/Chassis page															
13. Strike															
10-025	1-3/16" Lip, ANSI, no box, 1-1/4" x 4-7/8" (Std. on CY Chassis)														
10-072	1-3/16" Lip, 1-1/4" x 4-7/8" square corner, box (Std. on MS Chassis)														
For options see individual Class/Chassis page															
14. Door thickness															
134	1-3/4" (Std.)														
For options see individual Class/Chassis page															
15. Additional options															

CO SERIES STANDALONE LOCKS

- CO Series standalone locks are the ideal solution for facilities that want the convenience and efficiency of electronic access control without the complexity or cost of a networked system.

CLASS ¹		
CO-100	Standalone, keypad only, manually programmable only	
CO-200	Standalone, user access rights stored on the lock, manually or computer programmable	
CO-220	Standalone, classroom security, remote local lockdown	
CO-250	Standalone, user rights stored on magnetic stripe card, computer programmable only	

CHASSIS		
CY: Cylindrical	Bored lock installed into round hole in the door	
MS: Mortise	Lock case installed into a mortise rectangular "pocket" in the door	
MD: Mortise Deadbolt	Mortise lock with built-in interconnected auxiliary deadbolt	
993R: Exit Trim	Rim/Concealed Vertical Rod* (CVR) & Concealed Vertical Cable* (CVC) * Metal door only	
993M: Exit Trim	Mortise	
993S: Exit Trim	Surface Vertical Rod (SVR)	
993DT: Exit Trim	Non-Functioning "Dummy" Exit Trim	





1. Exit trim is only available in 70 function on CO-200, CO-220, and CO-250 models.
 2. Exit trim utilizes universal hardware to simplify installation to a variety of exit device.

EXIT DEVICE COMPATIBILITY		Exit trim utilizes universal hardware to simplify installation to a variety of exit devices ¹			
Brand	Compatible exit devices	Rim	SVR	CVR/CVC ¹	Mortise
Von Duprin	98/99 and 98/99XP	●	●	●	●
Von Duprin	22/22F	●	●		
Falcon	25	●			
Corbin Russwin®	5000	●			
Precision™	21 ²	●			
Yale®	7000	●			
Dorma®	9300	●			
Sargent®	80 ³	●			



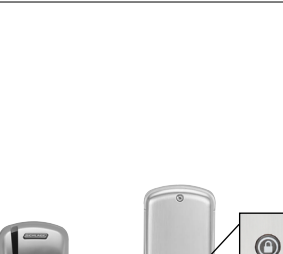
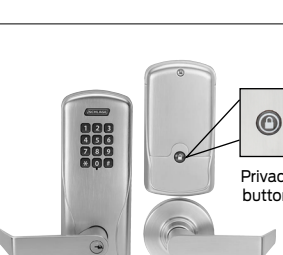

● CO-220 is not compatible with surface vertical rod (SVR) devices.

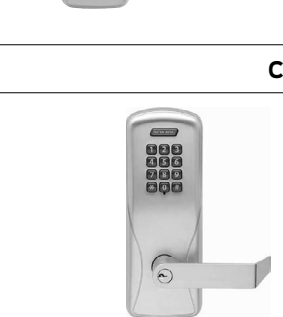
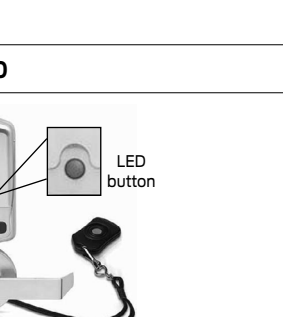
1. Metal door only.
2. 2100 converts to 21 with Precision's BP21 kit.
3. Narrow design and reversible rim exits not compatible.

FUNCTIONS

		CO-100	CO-200/CO-250
70: Storeroom	Lockset is normally secure. Inside lever always allows free egress. Valid toggle credentials on the exterior may be used to change to a passage or secured status.		
50: Office/ Classroom	Lockset is normally secure. Inside lever always allows free egress. Interior pushbutton on inside housing may be used to select a passage or secured status. Meets need for lockdown function for safety and security. NOTE: Valid toggle credentials on the exterior may also be used to change status. Has interior pushbutton (IPB).		
40: Privacy	Lockset is normally secure. Inside lever always allows free egress. Interior pushbutton on inside housing may be used to select a privacy status. The interior pushbutton will disable normal electronic access from the exterior. Opening the door or pressing the interior pushbutton a second time on the inside housing deactivates the privacy status. Has interior pushbutton (IPB).		
CO-220			
75: Classroom Security	Operates like a standard Storeroom (70)function. When remote fob is pressed to initiate immediate local lockdown, all normal credentials are rejected and only an authorized pass through credential will allow access. Inside lever always allows free egress.		

READER

<p>KP: Keypad</p>	<p>12 button design</p>	
<p>MS: Magnetic Stripe (Swipe)</p>	<p>Configurable to read the complete Track 1, 2 or 3.</p>	
<p>MSK: Magnetic Stripe + Keypad (Swipe)</p>	<p>Configurable to read the complete Track 1, 2 or 3.</p>	
<p>PR: Proximity</p>	<p>Reads 125 kHz proximity credentials</p>	
<p>PRK: Proximity + Keypad</p>	<p>Reads 125 kHz proximity credentials</p>	

Please refer to CO Series data sheets and solution sheets prior to ordering to verify credential compatibility.

LEVER DESIGNS
ATHENS (ATH)²

Tactile option: 8AT (knurled)

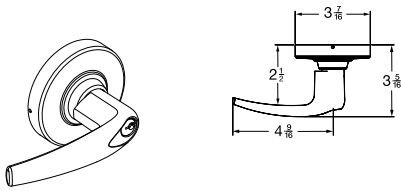
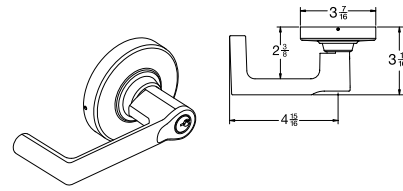
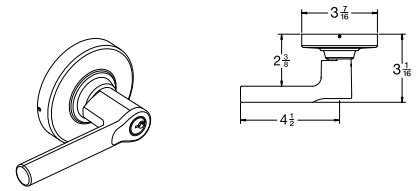
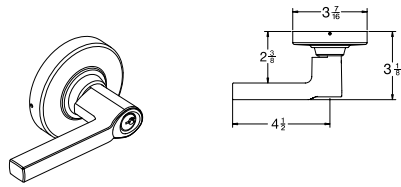
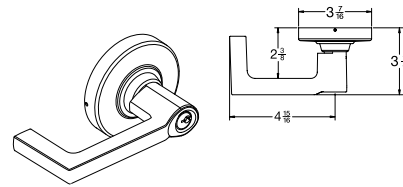
BOARDWALK (BRK)

BROADWAY (BRW)

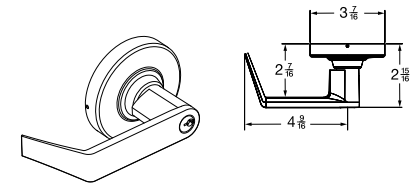
LATITUDE (LAT)

LONGITUDE (LON)

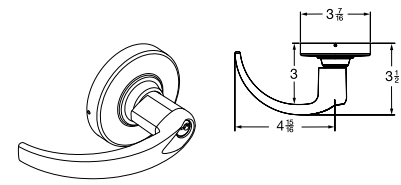
RHODES (RHO)

Tactile option: 8RO (knurled)

SPARTA (SPA)²

Tactile option: 8SP (knurled)

TUBULAR (TLR)²

Tactile option: 8TR (knurled)

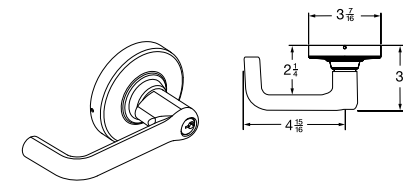

1. All lever designs are available in finishes 605, 606, 612, 619, 625, 626, 643E and 626AM.
2. ATH, SPA, and TLR levers meet California Fire Code for 1/2" or less return to door.
3. Changing lever cylinder compatibility on a device typically requires replacement of existing spring cage and tailpiece.
4. Tactile warning is applied to exterior lever only unless otherwise specified. Not available with 643e finish.
5. AD Series, CO Series, and ND Series levers may be interchangeable in some cases depending whether it is an interior or exterior lever, the type of chassis, and the type of cylinder/spring cage/tailpiece. Please consult the [AD Series Parts Guide](#) for more information.

FINISH CHART

Finish description	Finish No.	BHMA No.	Government
Bright Brass	605	605E	US3
Satin Brass	606	606E	US4
Satin Bronze	612	612E	US10
Satin Nickel	619		
Bright Chrome	625	625E	US26
Satin Chrome	626	626E	US26D
Satin Chrome Antimicrobial	626AM		

 Please refer to the Electronic Access Control catalog or online product information at us.allegion.com to view each finish.

COMPLETE LOCKS CYLINDERS

Keyed locks are priced including the P6 cylinder with open keyway. Provided below are pricing adjustments based on other available cylinder types. For Primus and Primus XP cylinders, order lock less cylinder and order the Primus or Primus XP cylinder separately.

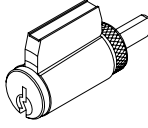
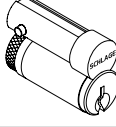
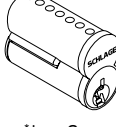
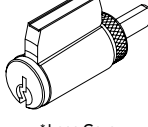
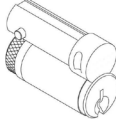
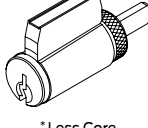
CYLINDERS		
P6	Conventional 6-pin cylinder Keyed different as standard with two keys.	
L	Less conventional cylinder	
R	FSIC (Full size interchangeable core) Keyway one bitted as standard with two keys.	
J	Less FSIC	
G	SFIC (Small format interchangeable core) 7-pin Factory master keyed with two keys as standard, master keying must be specified.	 * Less Core
B	Less SFIC	
L-SAR Ⓢ	Less cylinder, Sargent® (10L+11L) 6-pin Key-in-Lever (KIL)	 * Less Core
L-CO6 Ⓢ	Less cylinder, 6-pin Key-in-Lever (KIL)	
J-SAR Ⓢ	Less cylinder, Sargent 6300; 6-pin FSIC	 * Less Core
J-CO6 Ⓢ	Less cylinder, Corbin Russwin® 8000; 6-pin FSIC	
J-CO7 Ⓢ	Less cylinder, Corbin Russwin 8000-7; 7-pin FSIC (Only RHO, 8RO, SPA, 8SP, TLR, 8TR)	
J-MED Ⓢ	Less cylinder, Medeco 32*O201®; 6-pin FSIC	
J-YA6 Ⓢ	Less cylinder, Yale® 1210 or Medeco 31*O100; 6-pin FSIC	
J-YA7 Ⓢ	Less cylinder, Yale 1220; 7-pin FSIC	
L-FA7	Less cylinder, Falcon 7-pin Key-in-Lever (KIL) (Only RHO, 8RO, SPA, 8SP lever styles)	 * Less Core

Ⓢ Extended lead time

1. Competitor lever designs come in finishes 626 standard, and 605, 606, 612, 619, 625, 643e, and 626AM with extended lead-times.
2. For P, R and G -Master Keyed cylinders can be specified and will be shipped in lock packaging.
3. For Master Key System Summary form which should accompany the master keyed order, see pages 296–301.
4. For Master Keying, additional line item 50-210 is required for Classic and Everest cylinders.
5. Control Keys for installation/removal of interchangeable cores are not furnished and must be ordered separate.
6. For additional assistance on Master Keying as well as restricted keyways please contact your local sales representative.
7. Spring cages and tailpieces are different based on the type of cylinder and chassis selected. Please see the [CO Series Parts Guide](#) for more information.
8. The CO Series accepts many popular models of standard, SFIC, and FSIC cylinders. Consult the [Keyway/Cylinder Compatibility Data Sheet](#) (010432) for details. See price book for specific configurations.

COMPLETE LOCKS KEY SYSTEMS

KEY SYSTEMS AVAILABLE THROUGH SCHLAGE		
Default	Keyway family	Description
▪	Everest 29™ S Keyway Family	Patent protected open keyways that are available in full size Key In Lever (KIL) and Full Size Interchangeable Core (FSIC) formats. Patent protection through 2029.
	Everest 29 T Keyway Family	Patent protected restricted keyways that are available in full size KIL and FSIC formats. Patent protection through 2029.
	Everest D Keyway Family	Restricted keyways that are available in full size KIL and FSIC formats.
	Everest C Keyway Family	Open keyways that are available in full size KIL and FSIC formats.
	Schlage Classic Open Keyways	Classic (C/E/F): Open keyways available in KIL and FSIC designs
	Everest B Keyway Family	Restricted keyways that are available on Small Format Interchangeable Core (SFIC).
	Everest 29 R Keyway Family	Patent protected restricted keyways that are available on SFIC. Patent protection through 2029.

1. Everest Restricted Keyways require a Letter of Authorization to be submitted with the order. See sample Letter of Authorization on page 302.
2. Full Size key systems (Everest 29 S and T, Everest C and D, Obverse and Quad) are available in Primus and Primus XP key system and must be ordered separately. Lock should be ordered less cylinder and Primus cylinder should be a separate line.

Contact your local RSO representative for assistance in determining which format and level of exclusivity best suits your needs.

COMPLETE LOCKS HANDING

HANDING		
RH	Right handed: Hinges on right opens inward	
LH	Left handed: Hinges on left opens inward	
RHR	Right handed reverse: Hinges on right opens outward	
LHR	Left handed reverse: Hinges on left opens outward	

1. Exit trim 993 chassis available only with RHR or LHR option.
2. Handing is field reversible, but requires removal of the exterior escutcheon cover. Please see CO Series installation instructions for details.

COMPLETE LOCKS BATTERY

BATTERY		
4B	4AA Battery holder and cover kit	

CO-Series locks use standard off-the-shelf AA batteries.

COMPLETE LOCKS
BACKSET AND LATCHBOLT (CYLINDRICAL CHASSIS)

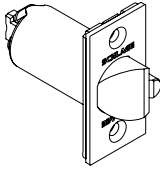
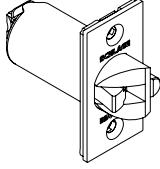
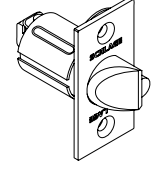
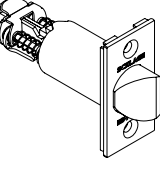
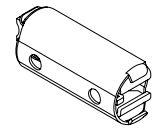
LATCHES		
13-247	2-3/4" Backset Deadlatch Square corner, 1-1/8" x 2-1/4"	
14-049	2-3/4" Backset Deadlatch Anti-friction fire door latch, Square corner, 1-1/8" x 2-1/4", 3/4" throw	
14-051	2-3/8" Backset Deadlatch Square corner, 1-1/8" x 2-1/4"	
14-050	3-3/4" Backset Deadlatch Square corner, 1-1/8" x 2-1/4"	
43-001	5" Backset extension link Deadlatch	
39-030	Rabbeted latch and strike kit, 605 and 626 only. Adapts square corner latch and 2-3/4" square corner strike to 1/2" rabbeted door and frame.	No image available

COMPLETE LOCKS MORTISE LOCK ARMOR FRONT (MORTISE/MORTISE DEADBOLT CHASSIS)

- For 1-3/4" thick doors, use wide armor front. For over 1-3/4" thick door extended equally (EE), use 1-1/4" wide armor front.
- Available finishes are 605, 606, 612, 619, 625, and 626.

ARMOR FRONT		
09-663	1-1/4" Wide square corner, latch for MS	
09-669	1-1/16" Wide square corner, latch, options for MS	
09-666	1-1/4" Wide square corner, latch x deadbolt for MD	
09-672	1-1/16" Wide square corner, latch x deadbolt, options for MD	

Images not shown to scale. Consult [CO Series Parts Guide](#) for more information.

COMPLETE LOCKS

STRIKE PLATES (CYLINDRICAL CHASSIS)

STRIKES WITH LOCKS		
10-025	1-3/16" Lip, ANSI, no box, 1-1/14" x 4-7/8",	
10-013	1-1/8" Lip, square corner, T-strike, box, 1-1/8" – 2-3/4", 1-1/2" Lip available, must specify 1-1/2" Lip	
10-016	1-1/8" Lip, square corner, T-strike, deep box, fire door latch	
K510-066	Box for ANSI strike (Must be specific)	
10-072	1-3/16" Lip, 1-1/4" x 4-7/8", square corner, box	
10-072	7/8", 1", 1-1/2", 1-3/4", or 2" Lip, 1-1/4" x 4-7/8", square corner, box	
10-075	1/2" Rabbeted, For 1-3/4" thick doors, use wide armor front. For over 1-3/4" thick door extended equally (EE) use 1-1/4" wide armor front.	
37-015	Strike frame reinforcer, specify 37-015	
XL11-820	One hole for latching functions, RH & LHR doors Lip 1-3/16"	
XL11-821	One hole for latching functions, LH & RHR doors Lip 1-3/16"	
XQ07-351-134	Strike, ANSI, No Box, 1-1/4" x 4-7/8", 1-3/4" Lip Length	Image not available
XQ03-494-134	Strike, square corner, T-strike, box, 1-1/8" x 2-3/4", 1-3/4" Lip	Image not available

XL11-820 and XL11-821 Extended lead time; contact customer service.



COMPLETE LOCKS DOOR DIMENSIONS

- Specify door thickness on order only if different than 1-3/4" thick door
- Door thickness should be specified to the nearest 1/8"

DOOR THICKNESS	
1-3/4"	1-3/4"
1-3/8"	1-3/8" to 2-3/4", Shims included (Specify in 1/8" increments)

1. Door thickness kits are available on page 256 to install a lock on a door that is thicker or thinner than 1-3/4". See [AD Series Parts Guide](#) for details. Locks cannot be installed on doors thicker than 2-3/4" or thinner than 1-3/8".
2. Thin door shims are available on page 256 to install a lock on a door that is thinner than 1-3/4".
3. Decorative plates are used to cover exposed holes when retrofitting from existing locks to AD Series locks. The size of plate required will vary based on the size and location of holes being covered. Retrofit information can be found at www.schlage.com/support.
4. If under the lock decorative plates are on both sides of device, then door will become 1/8" thicker. A door thickness kit of an incremental 1/8" must be ordered to accommodate under the lock plates.

STANDALONE LOCKS

PARTS



CO-100 STANDALONE

CYLINDRICAL



1-5. Select chassis/function/reader (Note: CO Series readers are not interchangeable.)		Price
CO-100-CY-70-KP	Storeroom with Keypad Reader; manually programmed	\$1,092.00
CO-100-CY-50-KP	Office/Classroom with Keypad Reader; manually programmed	\$1,102.00
CO-100-CY-40-KP	Privacy with Keypad Reader; manually programmed	\$1,102.00

6. Select lever ¹		Price adjustment
LLL	Less each lever	-\$31.00
Standard options	SPA (Sparta), RHO (Rhodes), ATH (Athens), TLR (Tubular), BRW (Broadway), BRK (Boardwalk), LAT (Latitude), LON (Longitude)	No charge

1. Tactile Warning use 8AT for Athens, 8RO for Rhodes, 8SP for Sparta and 8TR for Tubular. \$67.00 per lever. Applied to exterior lever only unless otherwise specified. Not available with 643e finish.

7. Select finish		Price adjustment
626	Satin Chrome	No charge
605	Bright Brass	\$166.00
606	Satin Brass	\$166.00
612 ⁴	Satin Bronze	\$166.00
619	Satin Nickel	\$166.00
625	Bright Chrome	\$166.00
643e	Aged Bronze	\$166.00
626AM	Satin Chrome Antimicrobial	\$215.00

8. Select cylinder type		Price adjustment	
		Open	Restricted
<input type="checkbox"/> ● P6	With Cylinder, Schlage - (Everest 29 S123, 6-pin KIL standard)	No charge	\$30.00
L	Less Cylinder, Schlage, Falcon, 6-pin KIL	-\$90.00	-\$90.00
<input type="checkbox"/> ● R	With Cylinder, Schlage 6-pin (Everest 29 S123 standard) FSIC	\$102.00	\$132.00
J	Less Cylinder, Schlage, 6-pin FSIC	-\$55.00	-\$55.00
<input type="checkbox"/> ● G	With Cylinder, Schlage 7-pin (Everest 29R standard) (factory master keyed only) SFIC	N/A	\$113.00
B	Less Cylinder, Schlage, Falcon, Competitive OEM's, 7-pin (SFIC)	-\$55.00	-\$55.00
L-SAR	Less Cylinder, Sargent (10L + 11L), 6-pin KIL (Only RHO, 8RO, SPA, 8SP, TLR, 8TR, ATH, 8AT lever styles)	No charge	No charge
L-CO6	Less Cylinder, Corbin, 6-pin KIL (Only RHO, 8RO, SPA, 8SP lever styles)	No charge	No charge
J-SAR	Less Cylinder, Sargent 6300, 6-pin FSIC	No charge	No charge
J-CO6	Less Cylinder, Corbin 8000, 6-pin FSIC	No charge	No charge
J-CO7	Less Cylinder, Corbin 8000-7, 7-pin FSIC, (Only RHO, 8RO, SPA, 8SP, TLR and 8TR)	No charge	No charge
J-MED	Less Cylinder, Medeco 32*0201, 6-pin FSIC (Only RHO, 8RO, SPA, 8SP lever styles)	No charge	No charge
J-YA6	Less Cylinder, Yale 1210 or Medeco 31*0100, 6-pin FSIC	No charge	No charge
J-YA7	Less Cylinder, Yale 1220, 7-pin FSIC (Only RHO, 8RO, SPA, 8SP lever styles)	No charge	No charge
L-FA7	Less Cylinder, Falcon, 7-pin, KIL (Only RHO, 8RO, SPA, 8SP lever styles)	No charge	No charge

● Master Keyed cylinders can be specified and will be shipped in lock packaging. For Master Keying System Summary form which should accompany the master keyed order, see page 296.

△ For master keying, an additional charge of \$28.30 each applies. Specify line item 50-210.

Control keys for installation/removal of interchangeable cores are not furnished and must be ordered separate.

For additional assistance on Master Keying as well as restricted keyways, please contact customer service.

CREDENTIALS

READERS

READER CONTROLLERS

MULTI-FAMILY

ENGAGE

AD SERIES

CO SERIES

ELECTROMAGNETIC LOCKS

POWER SUPPLIES

VON DUPRIN ACCESS CONTROL

SYSTEM ACC

MISC



CO-100 STANDALONE CYLINDRICAL

9. Select keying type **Price adjustment**

Open keyway families: KIL or FSIC ²		
S123	Everest 29 S (Key in Lever or FSIC)	Standard
C123	Everest C	No charge
C/CE/E/EF/F/FG/G	Classic Obverse	No charge
Restricted keyway families: KIL or FSIC ^{2,3}		
29T	Everest 29 T	\$30.00
D	Everest D	\$30.00
Classic Restricted	Quad, Numbered, Reverse	\$30.00
Restricted keyway families: SFIC ⁴		
29 R	Everest 29 R	No charge
B	Everest B	No charge

2. Full Size key systems (Everest 29 S and T, Everest C and D, Obverse and Quad) are available in Primus and Primus XP key system and must be ordered separately. Lock should be ordered less cylinder and Primus cylinder should be a separate line.
3. Everest Restricted Keyways require a Letter of Authorization to be submitted with the order. See page 302 for sample Letter of Authorization.
4. Master Keyed cylinders can be specified and will be shipped in lock packaging. For Master Keying System Summary form which should accompany the master keyed order, see page 296.

10. Select handing (field reversible) **Price adjustment**

RH	Right handed	No charge
LH	Left handed	No charge
RHR	Right handed reverse	No charge
LHR	Left handed reverse	No charge

11. Select battery **Price adjustment**

4B	4AA Battery kit	Standard
----	-----------------	----------

12. Select backset and latch bolt **Price adjustment**

LLL	Less Latch	-\$51.00
13-247	2-3/4" Backset, deadlatch, square corner, 1-1/8" x 2-1/4"	Standard
14-049	2-3/4" Backset, deadlatch anti-friction fire door latch, square corner, 1-1/8" x 2-1/4", 3/4" throw	\$268.00
14-051	2-3/8" Backset, deadlatch, square corner, 1-1/8" x 2-1/4"	No charge
14-050	3-3/4" Backset, deadlatch, square corner, 1-1/8" x 2-1/4"	\$16.00
43-001	5" Backset extension link, Deadlatch	\$47.00
39-030 ⁵	Rabbeted latch and strike kit, 605 and 626 only	\$85.00

5. Adapts square corner latch and 2-3/4" square corner strike to 1/2" rabbeted door and frame.

13. Select strike plate **Price adjustment**

LLL	Less Strike Plate	-\$6.60
10-025	1-3/16" Lip, ANSI, no box, 1-1/14" x 4-7/8"	Standard
10-013 ⁶	1-1/8" Lip, square corner, T-strike, box, 1-1/8" - 2-3/4"	No charge
10-016	1-1/8" Lip, square corner, T-strike, deep box, fire door latch	\$21.80
K510-066	Box for ANSI strike (Must be specific)	No charge

6. 1-1/2" Lip available, must specify 1-1/2" Lip \$9.90.

14. Select door thickness **Price adjustment**

134	1-3/4"	Standard
Example 138	1-3/8" to 2-3/4", Shims included (Specify in 1/8" increments)	\$83.00

Accessories available, see pages 239–240.

Credentials available, see pages 16–20.

CO-100 STANDALONE
MORTISE/MORTISE DEADBOLT

1-5. Select chassis/function/reader (Note: CO Series readers are not interchangeable.)		Price
CO-100-MS-70-KP	Storeroom with Keypad Reader; manually programmed	\$1,301.00
CO-100-MS-50-KP	Office/Classroom with Keypad Reader; manually programmed	\$1,311.00
CO-100-MS-40-KP	Privacy with Keypad Reader; manually programmed	\$1,311.00
CO-100-MD-40-KP	Privacy with Mortise Deadbolt with Keypad Reader; manually programmed	\$1,436.00



CO-100-MS-70-KP

6. Select lever ¹		Price adjustment
LLL	Less interior and exterior levers	-\$89.60
Standard options	SPA (Sparta), RHO (Rhodes), ATH (Athens), TLR (Tubular), BRW (Broadway), BRK (Boardwalk), LAT (Latitude), LON (Longitude)	No charge

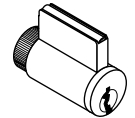
 Full Cylinder
P6, L, L-SAR, L-FA7

1. Tactile Warning use 8AT for Athens, 8RO for Rhodes, 8SP for Sparta and 8TR for Tubular. \$67.00 per lever. Applied to exterior lever only unless otherwise specified. Not available with 643e finish.

7. Select finish		Price adjustment
626	Satin Chrome	No charge
605	Bright Brass	\$166.00
606	Satin Brass	\$166.00
612	Satin Bronze	\$166.00
619	Satin Nickel	\$166.00
625	Bright Chrome	\$166.00
643e	Aged Bronze	\$166.00
626AM	Satin Chrome Antimicrobial	\$215.00

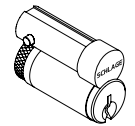
 FSIC Format
R, J, J-SAR, J-CO6,
J-CO7, J-YA6

8. Select cylinder type		Price adjustment	
		Open	Restricted
<input type="checkbox"/> ● P6	With Cylinder, Schlage - (Everest 29 S123, 6-pin KIL standard)	No charge	\$30.00
L	Less Cylinder, Schlage, Falcon, 6-pin KIL	-\$90.00	-\$90.00
<input type="checkbox"/> ● R	With Cylinder, Schlage 6-pin (Everest 29 S123 standard) FSIC	\$102.00	\$132.00
J	Less Cylinder, Schlage, 6-pin FSIC	-\$55.00	-\$55.00
<input type="checkbox"/> ● G	With Cylinder, Schlage 7-pin (Everest 29R standard) (factory master keyed only) SFIC	N/A	\$113.00
B	Less Cylinder, Schlage, Falcon, Competitive OEM's, 7-pin (SFIC)	-\$55.00	-\$55.00
L-SAR	Less Cylinder, Sargent (10L + 11L), 6-pin KIL (Only RHO, 8RO, SPA, 8SP, TLR, 8TR, ATH, 8AT lever styles)	No charge	No charge
L-CO6	Less Cylinder, Corbin, 6-pin KIL (Only RHO, 8RO, SPA, 8SP lever styles)	No charge	No charge
J-SAR	Less Cylinder, Sargent 6300, 6-pin FSIC	No charge	No charge
J-CO6	Less Cylinder, Corbin 8000, 6-pin FSIC	No charge	No charge
J-CO7	Less Cylinder, Corbin 8000-7, 7-pin FSIC, (Only RHO, 8RO, SPA, 8SP, TLR and 8TR)	No charge	No charge
J-MED	Less Cylinder, Medeco 32*0201, 6-pin FSIC (Only RHO, 8RO, SPA, 8SP lever styles)	No charge	No charge
J-YA6	Less Cylinder, Yale 1210 or Medeco 31*0100, 6-pin FSIC	No charge	No charge
J-YA7	Less Cylinder, Yale 1220, 7-pin FSIC (Only RHO, 8RO, SPA, 8SP lever styles)	No charge	No charge
L-FA7	Less Cylinder, Falcon, 7-pin, KIL (Only RHO, 8RO, SPA, 8SP lever styles)	No charge	No charge

 SFIC Format
B, G

● Master Keyed cylinders can be specified and will be shipped in lock packaging. For Master Keying System Summary form which should accompany the master keyed order, see page 296.

△ For master keying, an additional charge of \$28.30 each applies. Specify line item 50-210.

□ Control keys for installation/removal of interchangeable cores are not furnished and must be ordered separate.

For additional assistance on Master Keying as well as restricted keyways, please contact customer service.



CO-100 STANDALONE

MORTISE/MORTISE DEADBOLT

9. Select keying type **Price adjustment**

Open keyway families: KIL or FSIC²		
S123	Everest 29 S (Key in Lever or FSIC)	Standard
C123	Everest C	No charge
C/CE/E/EF/F/FG/G	Classic Obverse	No charge
Restricted keyway families: KIL or FSIC^{2,3}		
29T	Everest 29 T	\$30.00
D	Everest D	\$30.00
Classic Restricted	Quad, Numbered, Reverse	\$30.00
Restricted keyway families: SFIC⁴		
29 R	Everest 29 R	No charge
B	Everest B	No charge

2. Full Size key systems (Everest 29 S and T, Everest C and D, Obverse and Quad) are available in Primus and Primus XP key system and must be ordered separately. Lock should be ordered less cylinder and Primus cylinder should be a separate line.
3. Everest Restricted Keyways require a Letter of Authorization to be submitted with the order. See page 302 for sample Letter of Authorization.
4. Master Keyed cylinders can be specified and will be shipped in lock packaging. For Master Keying System Summary form which should accompany the master keyed order, see page 296.

10. Select handing (field reversible) **Price adjustment**

RH	Right handed	No charge
LH	Left handed	No charge
RHR	Right handed reverse	No charge
LHR	Left handed reverse	No charge

11. Select battery **Price adjustment**

4B	4AA Battery kit	Standard
----	-----------------	----------

12. Select mortise lock armor front **Price adjustment**

LLL	Less Armor Front	-\$25.00
09-663	1-1/4" Wide square corner, latch for MS	Standard
09-669	1-1/16" Wide square corner, Latch, options for MS	No charge
09-666	1-1/4" Wide square corner, latch x deadbolt for MD	Standard
09-672	1-1/16" Wide square corner, latch x deadbolt, options for MD	No charge

13. Select strike plate **Price adjustment**

LLL	Less Strike	-\$18.40
10-072	1-1/4" x 4-7/8" Square corner + box; 1-3/16" lip length	Standard
10-072xx	1-1/4" x 4-7/8" Square corner + box; specify lip length (xx) as 1" or 1-1/2"	No charge
10-072xx	1-1/4" x 4-7/8" Square corner + box; specify lip length (xx) as 1-3/4"	\$45.00
10-075 ⁵	1/2" Rabbeted	\$155.00
37-015	Strike frame reinforcer, specify 37-015	No charge

5. For 1-3/4" thick doors, use wide armor front. For over 1-3/4" thick door extended equally (EE) use 1-1/4" wide armor front.
 ⚠ Extended lead time, consult customer service.

14. Select door thickness **Price adjustment**

134	1-3/4"	Standard
Example 138	1-3/8" to 2-3/4", Shims included (Specify in 1/8" increments)	\$83.00

Accessories available, see pages 239–240.

Credentials available, see pages 16–20.

CO-100 STANDALONE
EXIT TRIM

1-3. Select chassis/function/reader (Note: CO Series readers are not interchangeable.)		Price
CO-100-993R-70-KP ¹	Exit Rim / Concealed Vertical Rod ² / Concealed Vertical Cable ² with Keypad Reader, manually programmed	\$1,507.00
CO-100-993R-40-KP ¹	Privacy with Keypad Reader; manually programmed	\$1,507.00
CO-100-993R-50-KP	Office/Classroom with Keypad Reader; manually programmed	\$1,507.00
CO-100-993S-70-KP ¹	Exit Surface Vertical Rod with Keypad Reader, manually programmed	\$1,519.00
CO-100-993M-70-KP ¹	Exit Mortise Lock with Keypad Reader, manually programmed	\$1,519.00

- See page 201 for exit device compatibility.
- Metal door only.

4. Select function		Price adjustment
70	Storeroom	Standard

5. Select lever ³		Price adjustment
LLL	Less interior and exterior levers	-\$31.00
Standard options	SPA (Sparta), RHO (Rhodes), ATH (Athens), TLR (Tubular), BRW (Broadway), BRK (Boardwalk), LAT (Latitude), LON (Longitude)	No charge

- Tactile Warning use 8AT for Athens, 8RO for Rhodes, 8SP for Sparta and 8TR for Tubular. \$67.00 per lever. Applied to exterior lever only unless otherwise specified. Not available with 643e finish.

6. Select finish		Price adjustment
626	Satin Chrome	No charge
605	Bright Brass	\$166.00
606	Satin Brass	\$166.00
612	Satin Bronze	\$166.00
619	Satin Nickel	\$166.00
625	Bright Chrome	\$166.00
643e	Aged Bronze	\$166.00
626AM	Satin Chrome Antimicrobial	\$215.00

7. Select cylinder type		Price adjustment	
		Open	Restricted
△ ● P6	With Cylinder, Schlage - (Everest 29 S123, 6-pin KIL standard)	No charge	\$30.00
L	Less Cylinder, Schlage, Falcon, 6-pin KIL	-\$90.00	-\$90.00
□ ● R	With Cylinder, Schlage 6-pin (Everest 29 S123 standard) FSIC	\$102.00	\$132.00
J	Less Cylinder, Schlage, 6-pin FSIC	-\$55.00	-\$55.00
□ ● G	With Cylinder, Schlage 7-pin (Everest 29R standard) (factory master keyed only) SFIC	N/A	\$113.00
B	Less Cylinder, Schlage, Falcon, Competitive OEM's, 7-pin (SFIC)	-\$55.00	-\$55.00
L-SAR	Less Cylinder, Sargent (10L + 11L), 6-pin KIL (Only RHO, 8RO, SPA, 8SP, TLR, 8TR, ATH, 8AT lever styles)	No charge	No charge
L-CO6	Less Cylinder, Corbin, 6-pin KIL (Only RHO, 8RO, SPA, 8SP lever styles)	No charge	No charge
J-SAR	Less Cylinder, Sargent 6300, 6-pin FSIC	No charge	No charge
J-CO6	Less Cylinder, Corbin 8000, 6-pin FSIC	No charge	No charge
J-CO7	Less Cylinder, Corbin 8000-7, 7-pin FSIC, (Only RHO, 8RO, SPA, 8SP, TLR and 8TR)	No charge	No charge
J-MED	Less Cylinder, Medeco 32*0201, 6-pin FSIC (Only RHO, 8RO, SPA, 8SP lever styles)	No charge	No charge
J-YA6	Less Cylinder, Yale 1210 or Medeco 31*0100, 6-pin FSIC	No charge	No charge
J-YA7	Less Cylinder, Yale 1220, 7-pin FSIC (Only RHO, 8RO, SPA, 8SP lever styles)	No charge	No charge
L-FA7	Less Cylinder, Falcon, 7-pin, KIL (Only RHO, 8RO, SPA, 8SP lever styles)	No charge	No charge

- Master Keyed cylinders can be specified and will be shipped in lock packaging. For Master Keying System Summary form which should accompany the master keyed order, see page 296.

△ For master keying, an additional charge of \$28.30 each applies. Specify line item 50-210.

□ Control keys for installation/removal of interchangeable cores are not furnished and must be ordered separate.

For additional assistance on Master Keying as well as restricted keyways, please contact customer service.

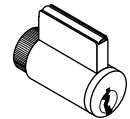
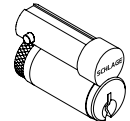
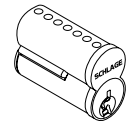

CO-100-993R-70-KP

 Full Cylinder
P6, L, L-SAR, L-FA7

 FSIC Format
R, J, J-SAR, J-CO6,
J-CO7, J-YA6

 SFIC Format
B, G



CO-100 STANDALONE EXIT TRIM

8. Select keying type		Price adjustment
Open keyway families: KIL or FSIC⁴		
S123	Everest 29 S (Key in Lever or FSIC)	Standard
C123	Everest C	No charge
C/CE/E/EF/F/FG/G	Classic Obverse	No charge
Restricted keyway families: KIL or FSIC^{4,5}		
29T	Everest 29 T	\$30.00
D	Everest D	\$30.00
Classic Restricted	Quad, Numbered, Reverse	\$30.00
Restricted keyway families: SFIC⁶		
29 R	Everest 29 R	No charge
B	Everest B	No charge

4. Full Size key systems (Everest 29 S and T, Everest C and D, Obverse and Quad) are available in Primus and Primus XP key system and must be ordered separately. Lock should be ordered less cylinder and Primus cylinder should be a separate line.
5. Everest Restricted Keyways require a Letter of Authorization to be submitted with the order. See page 302 for sample Letter of Authorization.
6. Master Keyed cylinders can be specified and will be shipped in lock packaging. For Master Keying System Summary form which should accompany the master keyed order, see page 296.

9. Select handing (field reversible)		Price adjustment
RH	Right handed	No charge
LH	Left handed	No charge
RHR	Right handed reverse	No charge
LHR	Left handed reverse	No charge

10. Select battery		Price adjustment
4B	4AA Battery kit	Standard

11. – 12. No selection required

13. Select door thickness		Price adjustment
134	1-3/4"	Standard
Example 200	1-3/8" to 2-3/4", Shims included (Specify in 1/8" increments)	\$83.00

Accessories available, see pages 239–240. Accessories include Decorative plates, SUS A-KIT, etc.

Credentials available, see pages 16–20.

CO Series Non-Functioning "Dummy" Exit trim now available. Please see pages 235–236 for details.

CO Series Exit trim

The CO-100 Exit trim comes with a universal mounting plate and is compatible with the following exit devices:

- **Von Duprin 98/99 and 98/99XP**
 - Rim, Concealed Vertical Rod (metal door only), Concealed Vertical Cable (metal door only), Surface Vertical Rod, Mortise.
- **Von Duprin 22/22F**
 - Rim, Surface Vertical Rod
- **Falcon 25** – Rim
- **Sargent 80 Series** (Narrow design and reversible rim exits not compatible) – Rim
- **Corbin Russwin 5000 Series** – Rim
- **Yale 7000** – Rim
- **Dorma 9300** – Rim
- **Precision 21** – Rim (2100 converts to 21 with Precision's BP21 Kit)



CO-200 STANDALONE

CYLINDRICAL



1-4. Select chassis/function		Price	
CO-200-CY-70	Storeroom	\$1,688.00	
CO-200-CY-50	Office/Classroom	\$1,698.00	
CO-200-CY-40	Privacy	\$1,698.00	
5. Select reader		Price adjustment	
(Note: CO Series readers are not interchangeable.)			
KP	Keypad	No charge	
MS	Magnetic stripe (Swipe)	\$139.00	
MSK	Magnetic stripe (Swipe) + keypad	\$229.00	
PR	Proximity	\$235.00	
PRK	Proximity + keypad	\$330.00	
6. Select lever ¹		Price adjustment	
LLL	Less each lever	-\$31.00	
Standard options	SPA (Sparta), RHO (Rhodes), ATH (Athens), TLR (Tubular), BRW (Broadway), BRK (Boardwalk), LAT (Latitude), LON (Longitude)	No charge	
1. Tactile Warning use 8AT for Athens, 8RO for Rhodes, 8SP for Sparta and 8TR for Tubular. \$67.00 per lever. Applied to exterior lever only unless otherwise specified. Not available with 643e finish.			
7. Select finish		Price adjustment	
626	Satin Chrome	No charge	
605	Bright Brass	\$166.00	
606	Satin Brass	\$166.00	
612 ⁴	Satin Bronze	\$166.00	
619	Satin Nickel	\$166.00	
625	Bright Chrome	\$166.00	
643e	Aged Bronze	\$166.00	
626AM	Satin Chrome Antimicrobial	\$215.00	
8. Select cylinder type		Price adjustment	
		Open	Restricted
<input type="checkbox"/> ● P6	With Cylinder, Schlage - (Everest 29 S123, 6-pin KIL standard)	No charge	\$30.00
L	Less Cylinder, Schlage, Falcon, 6-pin KIL	-\$90.00	-\$90.00
<input type="checkbox"/> ● R	With Cylinder, Schlage 6-pin (Everest 29 S123 standard) FSIC	\$102.00	\$132.00
J	Less Cylinder, Schlage, 6-pin FSIC	-\$55.00	-\$55.00
<input type="checkbox"/> ● G	With Cylinder, Schlage 7-pin (Everest 29R standard) (factory master keyed only) SFIC	N/A	\$113.00
B	Less Cylinder, Schlage, Falcon, Competitive OEM's, 7-pin (SFIC)	-\$55.00	-\$55.00
L-SAR	Less Cylinder, Sargent (10L + 11L), 6-pin KIL (Only RHO, 8RO, SPA, 8SP, TLR, 8TR, ATH, 8AT lever styles)	No charge	No charge
L-CO6	Less Cylinder, Corbin, 6-pin KIL (Only RHO, 8RO, SPA, 8SP lever styles)	No charge	No charge
J-SAR	Less Cylinder, Sargent 6300, 6-pin FSIC	No charge	No charge
J-CO6	Less Cylinder, Corbin 8000, 6-pin FSIC	No charge	No charge
J-CO7	Less Cylinder, Corbin 8000-7, 7-pin FSIC, (Only RHO, 8RO, SPA, 8SP, TLR and 8TR)	No charge	No charge
J-MED	Less Cylinder, Medeco 32*0201, 6-pin FSIC (Only RHO, 8RO, SPA, 8SP lever styles)	No charge	No charge
J-YA6	Less Cylinder, Yale 1210 or Medeco 31*0100, 6-pin FSIC	No charge	No charge
J-YA7	Less Cylinder, Yale 1220, 7-pin FSIC (Only RHO, 8RO, SPA, 8SP lever styles)	No charge	No charge
L-FA7	Less Cylinder, Falcon, 7-pin, KIL (Only RHO, 8RO, SPA, 8SP lever styles)	No charge	No charge

● Master Keyed cylinders can be specified and will be shipped in lock packaging. For Master Keying System Summary form which should accompany the master keyed order, see page 296.

△ For master keying, an additional charge of \$28.30 each applies. Specify line item 50-210.

Control keys for installation/removal of interchangeable cores are not furnished and must be ordered separate.

For additional assistance on Master Keying as well as restricted keyways, please contact customer service.



CO-200 STANDALONE

CYLINDRICAL

9. Select keying type **Price adjustment**

Open keyway families: KIL or FSIC²		
S123	Everest 29 S (Key in Lever or FSIC)	Standard
C123	Everest C	No charge
C/CE/E/EF/F/FG/G	Classic Obverse	No charge
Restricted keyway families: KIL or FSIC^{2,3}		
29T	Everest 29 T	\$30.00
D	Everest D	\$30.00
Classic Restricted	Quad, Numbered, Reverse	\$30.00
Restricted keyway families: SFIC⁴		
29 R	Everest 29 R	No charge
B	Everest B	No charge

2. Full Size key systems (Everest 29 S and T, Everest C and D, Obverse and Quad) are available in Primus and Primus XP key system and must be ordered separately. Lock should be ordered less cylinder and Primus cylinder should be a separate line.
3. Everest Restricted Keyways require a Letter of Authorization to be submitted with the order. See page 302 for sample Letter of Authorization.
4. Master Keyed cylinders can be specified and will be shipped in lock packaging. For Master Keying System Summary form which should accompany the master keyed order, see page 296.

10. Select handing (field reversible) **Price adjustment**

RH	Right handed	No charge
LH	Left handed	No charge
RHR	Right handed reverse	No charge
LHR	Left handed reverse	No charge

11. Select battery **Price adjustment**

4B	4AA Battery kit	Standard
----	-----------------	----------

12. Select backset and latch bolt **Price adjustment**

LLL	Less Latch	-\$51.00
13-247	2-3/4" Backset, deadlatch, square corner, 1-1/8" x 2-1/4"	Standard
14-049	2-3/4" Backset, deadlatch anti-friction fire door latch, square corner, 1-1/8" x 2-1/4", 3/4" throw	\$268.00
14-051	2-3/8" Backset, deadlatch, square corner, 1-1/8" x 2-1/4"	No charge
14-050	3-3/4" Backset, deadlatch, square corner, 1-1/8" x 2-1/4"	\$16.00
43-001	5" Backset extension link, Deadlatch	\$47.00
39-030 ⁵	Rabbeted latch and strike kit, 605 and 626 only	\$85.00

5. Adapts square corner latch and 2-3/4" square corner strike to 1/2" rabbeted door and frame.

13. Select strike plate **Price adjustment**

LLL	Less Strike Plate	-\$6.60
10-025	1-3/16" Lip, ANSI, no box, 1-1/14" x 4-7/8"	Standard
10-013 ⁶	1-1/8" Lip, square corner, T-strike, box, 1-1/8" - 2-3/4"	No charge
10-016	1-1/8" Lip, square corner, T-strike, deep box, fire door latch	No charge
K510-066	Box for ANSI strike (Must be specific)	No charge

6. 1-1/2" Lip available, must specify 1-1/2" Lip \$9.90.

14. Select door thickness **Price adjustment**

134	1-3/4"	Standard
Example 138	1-3/8" to 2-3/4", Shims included (Specify in 1/8" increments)	\$83.00

Accessories available, see pages 239–240. Accessories include Decorative plates, SUS A-KIT, etc.
 Credentials available, see pages 16–20.

CO-200 STANDALONE
MORTISE/MORTISE DEADBOLT

1-3. Select chassis		Price
CO-200-MS	Mortise	\$1,989.00
CO-200-MD	Mortise Deadbolt	\$2,085.00

4. Select function		Price adjustment
70	Storeroom (Not available on Mortise Deadbolt)	Standard
50	Office/Classroom (Not available on Mortise Deadbolt)	\$10.00
40 ¹	Privacy	\$10.00

1. Inside Push Button (IPB) only included with Mortise (MS) chassis. Mortise Deadbolt (MD) chassis comes with LED indicator only. \$10.00 charge does not apply to Mortise Deadbolt (MD) chassis.

5. Select reader (Note: CO Series readers are not interchangeable.)		Price adjustment
KP	Keypad	Standard
MS	Magnetic stripe (Swipe)	\$139.00
MSK	Magnetic stripe (Swipe) + keypad	\$229.00
PR	Proximity	\$235.00
PRK	Proximity + keypad	\$330.00

6. Select lever ²		Price adjustment
LLL	Less interior and exterior levers	-\$89.60
Standard options	SPA (Sparta), RHO (Rhodes), ATH (Athens), TLR (Tubular), BRW (Broadway), BRK (Boardwalk), LAT (Latitude), LON (Longitude)	No charge

2. Tactile Warning use 8AT for Athens, 8RO for Rhodes, 8SP for Sparta and 8TR for Tubular. \$67.00 per lever. Applied to exterior lever only unless otherwise specified. Not available with 643e finish.

7. Select finish		Price adjustment
626	Satin Chrome	No charge
605	Bright Brass	\$166.00
606	Satin Brass	\$166.00
612	Satin Bronze	\$166.00
619	Satin Nickel	\$166.00
625	Bright Chrome	\$166.00
643e	Aged Bronze	\$166.00
626AM	Satin Chrome Antimicrobial	\$215.00

8. Select cylinder type		Price adjustment	
		Open	Restricted
△ ● P6	With Cylinder, Schlage - (Everest 29 S123, 6-pin KIL standard)	No charge	\$30.00
L	Less Cylinder, Schlage, Falcon, 6-pin KIL	-\$90.00	-\$90.00
□ ● R	With Cylinder, Schlage 6-pin (Everest 29 S123 standard) FSIC	\$102.00	\$132.00
J	Less Cylinder, Schlage, 6-pin FSIC	-\$55.00	-\$55.00
□ ● G	With Cylinder, Schlage 7-pin (Everest 29R standard) (factory master keyed only) SFIC	N/A	\$113.00
B	Less Cylinder, Schlage, Falcon, Competitive OEM's, 7-pin (SFIC)	-\$55.00	-\$55.00
L-SAR	Less Cylinder, Sargent (10L + 11L), 6-pin KIL (Only RHO, 8RO, SPA, 8SP, TLR, 8TR, ATH, 8AT lever styles)	No charge	No charge
L-CO6	Less Cylinder, Corbin, 6-pin KIL (Only RHO, 8RO, SPA, 8SP lever styles)	No charge	No charge
J-SAR	Less Cylinder, Sargent 6300, 6-pin FSIC	No charge	No charge
J-CO6	Less Cylinder, Corbin 8000, 6-pin FSIC	No charge	No charge
J-CO7	Less Cylinder, Corbin 8000-7, 7-pin FSIC, (Only RHO, 8RO, SPA, 8SP, TLR and 8TR)	No charge	No charge
J-MED	Less Cylinder, Medeco 32*0201, 6-pin FSIC (Only RHO, 8RO, SPA, 8SP lever styles)	No charge	No charge
J-YA6	Less Cylinder, Yale 1210 or Medeco 31*0100, 6-pin FSIC	No charge	No charge
J-YA7	Less Cylinder, Yale 1220, 7-pin FSIC (Only RHO, 8RO, SPA, 8SP lever styles)	No charge	No charge
L-FA7	Less Cylinder, Falcon, 7-pin, KIL (Only RHO, 8RO, SPA, 8SP lever styles)	No charge	No charge

● Master Keyed cylinders can be specified and will be shipped in lock packaging. For Master Keying System Summary form which should accompany the master keyed order, see page 296.

△ For master keying, an additional charge of \$28.30 each applies. Specify line item 50-210.

□ Control keys for installation/removal of interchangeable cores are not furnished and must be ordered separate.

For additional assistance on Master Keying as well as restricted keyways, please contact customer service.



CO-200-MS-70-PR



CO-200-MS-70-PRK



CO-200-MS-70-MSK



CO-200-MS-70-MS



CO-200-MS-70-KP

CREDENTIALS

READERS

READER CONTROLLERS

MULTI-FAMILY

ENGAGE

AD SERIES

CO SERIES

ELECTROMAGNETIC LOCKS

POWER SUPPLIES

VON DUPRIN ACCESS CONTROL

SYSTEM ACC

MISC



CO-200 STANDALONE

MORTISE/MORTISE DEADBOLT

9. Select keying type **Price adjustment****Open keyway families: KIL or FSIC³**

S123	Everest 29 S (Key in Lever or FSIC)	Standard
C123	Everest C	No charge
C/CE/E/EF/F/FG/G	Classic Obverse	No charge

Restricted keyway families: KIL or FSIC^{3,4}

29T	Everest 29 T	\$30.00
D	Everest D	\$30.00
Classic Restricted	Quad, Numbered, Reverse	\$30.00

Restricted keyway families: SFIC⁵

29 R	Everest 29 R	No charge
B	Everest B	No charge

3. Full size key systems (Everest 29 S and T, Everest C and D, Obverse and Quad) are available in Primus and Primus XP key system and must be ordered separately. Lock should be ordered less cylinder and Primus cylinder should be a separate line.
4. Everest restricted keyways require a Letter of Authorization to be submitted with the order. See page 302 for sample Letter of Authorization.
5. Master keyed cylinders can be specified and will be shipped in lock packaging. For Master Keying System Summary form which should accompany the master keyed order, see page 296.

10. Select handing (field reversible) **Price adjustment**

RH	Right handed	No charge
LH	Left handed	No charge
RHR	Right handed reverse	No charge
LHR	Left handed reverse	No charge

11. Select battery **Price adjustment**

4B	4AA Battery kit	Standard
----	-----------------	----------

12. Select mortise lock armor front **Price adjustment**

LLL	Less Armor Front	-\$25.00
09-663	1-1/4" Wide square corner, latch for MS	Standard
09-669	1-1/16" Wide square corner, latch, options for MS	No charge
09-666	1-1/4" Wide square corner, latch x deadbolt for MD	Standard
09-672	1-1/16" Wide square corner, latch x deadbolt, options for MD	No charge

13. Select strike plate **Price adjustment**

LLL	Less Strike	-\$18.40
10-072	1-1/4" x 4-7/8" Square corner + box; 1-3/16" lip length	Standard
10-072xx	1-1/4" x 4-7/8" Square corner + box; specify lip length (xx) as 1" or 1-1/2"	No charge
10-072xx	1-1/4" x 4-7/8" Square corner + box; specify lip length (xx) as 1-3/4"	\$45.00
10-075 ⁶	1/2" Rabbeted	\$155.00
37-015	Strike frame reinforcer, specify 37-015	No charge

6. For 1-3/4" thick doors, use wide armor front. For over 1-3/4" thick door extended equally (EE) use 1-1/4" wide armor front.
- ⁶ Extended lead time, consult customer service.

14. Select door thickness **Price adjustment**

134	1-3/4"	Standard
Example 138	1-3/8" to 2-3/4", Shims included (Specify in 1/8" increments)	\$83.00

Accessories available, see pages 239–240. Accessories include Decorative plates, SUS A-KIT, etc.
 Credentials available, see pages 16–20.

CO-200 STANDALONE
EXIT TRIM

1-3. Select chassis/exit trim type		(Note: See page 201 for exit device compatibility.)	Price
CO-200-993R	Exit Rim / Concealed Vertical Rod (Metal Door) / Concealed Vertical Cable (Metal Door)		\$2,236.00
CO-200-993S	Exit Surface Vertical Rod		\$2,274.00
CO-200-993M	Exit Mortise Lock		\$2,274.00

4. Select function		Price adjustment
70	Storeroom	Standard

5. Select reader		(Note: CO Series readers are not interchangeable.)	Price adjustment
KP	Keypad		No charge
MS	Magnetic stripe (Swipe)		\$139.00
MSK	Magnetic stripe (Swipe) + keypad		\$229.00
PR	Proximity		\$235.00
PRK	Proximity + keypad		\$330.00

6. Select lever ¹		Price adjustment
LLL	Less interior and exterior levers	-\$31.00
Standard options	SPA (Sparta), RHO (Rhodes), ATH (Athens), TLR (Tubular), BRW (Broadway), BRK (Boardwalk), LAT (Latitude), LON (Longitude)	No charge

1. Tactile Warning use 8AT for Athens, 8RO for Rhodes, 8SP for Sparta and 8TR for Tubular. \$67.00 per lever. Applied to exterior lever only unless otherwise specified. Not available with 643e finish.

6. Select finish		Price adjustment
626	Satin Chrome	No charge
605	Bright Brass	\$166.00
606	Satin Brass	\$166.00
612	Satin Bronze	\$166.00
619	Satin Nickel	\$166.00
625	Bright Chrome	\$166.00
643e	Aged Bronze	\$166.00
626AM	Satin Chrome Antimicrobial	\$215.00

7. Select cylinder type		Price adjustment	
		Open	Restricted
<input checked="" type="checkbox"/> ● P6	With Cylinder, Schlage - (Everest 29 S123, 6-pin KIL standard)	No charge	\$30.00
<input type="checkbox"/> L	Less Cylinder, Schlage, Falcon, 6-pin KIL	-\$90.00	-\$90.00
<input checked="" type="checkbox"/> ● R	With Cylinder, Schlage 6-pin (Everest 29 S123 standard) FSIC	\$102.00	\$132.00
<input type="checkbox"/> J	Less Cylinder, Schlage, 6-pin FSIC	-\$55.00	-\$55.00
<input checked="" type="checkbox"/> ● G	With Cylinder, Schlage 7-pin (Everest 29R standard) (factory master keyed only) SFIC	N/A	\$113.00
<input type="checkbox"/> B	Less Cylinder, Schlage, Falcon, Competitive OEM's, 7-pin (SFIC)	-\$55.00	-\$55.00
<input type="checkbox"/> L-SAR	Less Cylinder, Sargent (10L + 11L), 6-pin KIL (Only RHO, 8RO, SPA, 8SP, TLR, 8TR, ATH, 8AT lever styles)	No charge	No charge
<input type="checkbox"/> L-CO6	Less Cylinder, Corbin, 6-pin KIL (Only RHO, 8RO, SPA, 8SP lever styles)	No charge	No charge
<input type="checkbox"/> J-SAR	Less Cylinder, Sargent 6300, 6-pin FSIC	No charge	No charge
<input type="checkbox"/> J-CO6	Less Cylinder, Corbin 8000, 6-pin FSIC	No charge	No charge
<input type="checkbox"/> J-CO7	Less Cylinder, Corbin 8000-7, 7-pin FSIC, (Only RHO, 8RO, SPA, 8SP, TLR and 8TR)	No charge	No charge
<input type="checkbox"/> J-MED	Less Cylinder, Medeco 32*0201, 6-pin FSIC (Only RHO, 8RO, SPA, 8SP lever styles)	No charge	No charge
<input type="checkbox"/> J-YA6	Less Cylinder, Yale 1210 or Medeco 31*0100, 6-pin FSIC	No charge	No charge
<input type="checkbox"/> J-YA7	Less Cylinder, Yale 1220, 7-pin FSIC (Only RHO, 8RO, SPA, 8SP lever styles)	No charge	No charge
<input type="checkbox"/> L-FA7	Less Cylinder, Falcon, 7-pin, KIL (Only RHO, 8RO, SPA, 8SP lever styles)	No charge	No charge

● Master Keyed cylinders can be specified and will be shipped in lock packaging. For Master Keying System Summary form which should accompany the master keyed order, see page 296.

△ For master keying, an additional charge of \$28.30 each applies. Specify line item 50-210.

□ Control keys for installation/removal of interchangeable cores are not furnished and must be ordered separate.

For additional assistance on Master Keying as well as restricted keyways, please contact customer service.



CO-200-993R-70-MSK



CO-200-993R-70-MS



CO-200-993R-70-KP



CO-200-993R-70-PR



CO-200-993R-70-PRK

CREDENTIALS

READERS

READER CONTROLLERS

MULTI-FAMILY

ENGAGE

AD SERIES

CO SERIES

ELECTROMAGNETIC LOCKS

POWER SUPPLIES

VON DUPRIN ACCESS CONTROL

SYSTEM ACC

MISC



CO-200 STANDALONE EXIT TRIM

9. Select keying type		Price adjustment
Open keyway families: KIL or FSIC³		
S123	Everest 29 S (Key in Lever or FSIC)	Standard
C123	Everest C	No charge
C/CE/E/EF/F/FG/G	Classic Obverse	No charge
Restricted keyway families: KIL or FSIC^{3,4}		
29T	Everest 29 T	\$30.00
D	Everest D	\$30.00
Classic Restricted	Quad, Numbered, Reverse	\$30.00
Restricted keyway families: SFIC⁵		
29 R	Everest 29 R	No charge
B	Everest B	No charge

- Full Size key systems (Everest 29 S and T, Everest C and D, Obverse and Quad) are available in Primus and Primus XP key system and must be ordered separately. Lock should be ordered less cylinder and Primus cylinder should be a separate line.
- Everest Restricted Keyways require a Letter of Authorization to be submitted with the order. See page 302 for sample Letter of Authorization.
- Master Keyed cylinders can be specified and will be shipped in lock packaging. For Master Keying System Summary form which should accompany the master keyed order, see page 296.

10. Select handing (field reversible)		Price adjustment
RHR	Right handed reverse	No charge
LHR	Left handed reverse	No charge

11. Select battery		Price adjustment
4B	4AA Battery kit	Standard

12. – 13. No selection required

14. Select door thickness		Price adjustment
134	1-3/4"	Standard
Example 200	1-3/4" to 2-3/4", (Specify in 1/8" increments)	\$83.00

Accessories available, see pages 239–240. Accessories include Decorative plates, SUS A-KIT, etc.

Credentials available, see pages 16–20.

CO Series Non-Functioning "Dummy" Exit trim now available. Please see pages 235–236 for details.

CO Series Exit trim

The CO-100 Exit trim comes with a universal mounting plate and is compatible with the following exit devices:

- **Von Duprin 98/99 and 98/99XP**
 - Rim, Concealed Vertical Rod (metal door only), Concealed Vertical Cable (metal door only), Surface Vertical Rod, Mortise.
- **Von Duprin 22/22F**
 - Rim, Surface Vertical Rod
- **Falcon 25** – Rim
- **Sargent 80 Series** (Narrow design and reversible rim exits not compatible) – Rim
- **Corbin Russwin 5000 Series** – Rim
- **Yale 7000** – Rim
- **Dorma 9300** – Rim
- **Precision 21** – Rim (2100 converts to 21 with Precision's BP21 Kit)

CO-220 STANDALONE
CYLINDRICAL

1-4. Select chassis/function
Price

CO-220-CY-75	Classroom Security	\$2,237.00
--------------	--------------------	------------

Price includes (1) pre-paired Remote Lockdown Fob, p/n 24744856, shipped with lock.
Additional fobs available under [CO Series Accessories](#).

5. Select reader

(Note: CO Series readers are not interchangeable.)

Price adjustment

KP	Keypad	No charge
MS	Magnetic stripe (Swipe)	\$139.00
MSK	Magnetic stripe (Swipe) + keypad	\$229.00
PR	Proximity	\$235.00
PRK	Proximity + keypad	\$330.00



CO-220-CY-75-PRK



CO-220-CY-75-PR

6. Select lever¹
Price adjustment

LLL	Less each lever	-\$31.00
Standard options	SPA (Sparta), RHO (Rhodes), ATH (Athens), TLR (Tubular), BRW (Broadway), BRK (Boardwalk), LAT (Latitude), LON (Longitude)	No charge

1. Tactile Warning use 8AT for Athens, 8RO for Rhodes, 8SP for Sparta and 8TR for Tubular. \$67.00 per lever. Applied to exterior lever only unless otherwise specified. Not available with 643e finish.

7. Select finish
Price adjustment

626	Satin Chrome	No charge
605	Bright Brass	\$166.00
606	Satin Brass	\$166.00
612 ⁴	Satin Bronze	\$166.00
619	Satin Nickel	\$166.00
625	Bright Chrome	\$166.00
643e	Aged Bronze	\$166.00
626AM	Satin Chrome Antimicrobial	\$215.00



CO-220-CY-75-MSK



CO-220-CY-75-MS



CO-220-CY-75-KP

8. Select cylinder type
Price adjustment
Open Restricted

<input type="checkbox"/> ● P6	With Cylinder, Schlage - (Everest 29 S123, 6-pin KIL standard)	No charge	\$30.00
L	Less Cylinder, Schlage, Falcon, 6-pin KIL	-\$90.00	-\$90.00
<input type="checkbox"/> ● R	With Cylinder, Schlage 6-pin (Everest 29 S123 standard) FSIC	\$102.00	\$132.00
J	Less Cylinder, Schlage, 6-pin FSIC	-\$55.00	-\$55.00
<input type="checkbox"/> ● G	With Cylinder, Schlage 7-pin (Everest 29R standard) (factory master keyed only) SFIC	N/A	\$113.00
B	Less Cylinder, Schlage, Falcon, Competitive OEM's, 7-pin (SFIC)	-\$55.00	-\$55.00
L-SAR	Less Cylinder, Sargent (10L + 11L), 6-pin KIL (Only RHO, 8RO, SPA, 8SP, TLR, 8TR, ATH, 8AT lever styles)	No charge	No charge
L-CO6	Less Cylinder, Corbin, 6-pin KIL (Only RHO, 8RO, SPA, 8SP lever styles)	No charge	No charge
J-SAR	Less Cylinder, Sargent 6300, 6-pin FSIC	No charge	No charge
J-CO6	Less Cylinder, Corbin 8000, 6-pin FSIC	No charge	No charge
J-CO7	Less Cylinder, Corbin 8000-7, 7-pin FSIC, (Only RHO, 8RO, SPA, 8SP, TLR and 8TR)	No charge	No charge
J-MED	Less Cylinder, Medeco 32*0201, 6-pin FSIC (Only RHO, 8RO, SPA, 8SP lever styles)	No charge	No charge
J-YA6	Less Cylinder, Yale 1210 or Medeco 31*0100, 6-pin FSIC	No charge	No charge
J-YA7	Less Cylinder, Yale 1220, 7-pin FSIC (Only RHO, 8RO, SPA, 8SP lever styles)	No charge	No charge
L-FA7	Less Cylinder, Falcon, 7-pin, KIL (Only RHO, 8RO, SPA, 8SP lever styles)	No charge	No charge

● Master Keyed cylinders can be specified and will be shipped in lock packaging. For Master Keying System Summary form which should accompany the master keyed order, see page 296.

△ For master keying, an additional charge of \$28.30 each applies. Specify line item 50-210.

Control keys for installation/removal of interchangeable cores are not furnished and must be ordered separate.

For additional assistance on Master Keying as well as restricted keyways, please contact customer service.



CO-220 STANDALONE CYLINDRICAL

9. Select keying type **Price adjustment**

Open keyway families: KIL or FSIC ²		
S123	Everest 29 S (Key in Lever or FSIC)	Standard
C123	Everest C	No charge
C/CE/E/EF/F/FG/G	Classic Obverse	No charge
Restricted keyway families: KIL or FSIC ^{2,3}		
29T	Everest 29 T	\$30.00
D	Everest D	\$30.00
Classic Restricted	Quad, Numbered, Reverse	\$30.00
Restricted keyway families: SFIC ⁴		
29 R	Everest 29 R	No charge
B	Everest B	No charge

2. Full Size key systems (Everest 29 S and T, Everest C and D, Obverse and Quad) are available in Primus and Primus XP key system and must be ordered separately. Lock should be ordered less cylinder and Primus cylinder should be a separate line.
3. Everest Restricted Keyways require a Letter of Authorization to be submitted with the order. See page 302 for sample Letter of Authorization.
4. Master Keyed cylinders can be specified and will be shipped in lock packaging. For Master Keying System Summary form which should accompany the master keyed order, see page 296.

10. Select handing (field reversible) **Price adjustment**

RH	Right handed	No charge
LH	Left handed	No charge
RHR	Right handed reverse	No charge
LHR	Left handed reverse	No charge

11. Select battery **Price adjustment**

4B	4AA Battery kit	Standard
----	-----------------	----------

12. Select backset and latch bolt **Price adjustment**

LLL	Less Latch	-\$51.00
13-247	2-3/4" Backset, deadlatch, square corner, 1-1/8" x 2-1/4"	Standard
14-049	2-3/4" Backset, deadlatch anti-friction fire door latch, square corner, 1-1/8" x 2-1/4", 3/4" throw	\$268.00
14-051	2-3/8" Backset, deadlatch, square corner, 1-1/8" x 2-1/4"	No charge
14-050	3-3/4" Backset, deadlatch, square corner, 1-1/8" x 2-1/4"	\$16.00
43-001	5" Backset extension link, Deadlatch	\$47.00
39-030 ⁵	Rabbeted latch and strike kit, 605 and 626 only	\$85.00

5. Adapts square corner latch and 2-3/4" square corner strike to 1/2" rabbeted door and frame.

13. Select strike plate **Price adjustment**

LLL	Less Strike Plate	-\$6.60
10-025	1-3/16" Lip, ANSI, no box, 1-1/14" x 4-7/8"	Standard
10-013 ⁶	1-1/8" Lip, square corner, T-strike, box, 1-1/8" - 2-3/4"	No charge
10-016	1-1/8" Lip, square corner, T-strike, deep box, fire door latch	No charge
K510-066	Box for ANSI strike (Must be specific)	No charge

6. 1-1/2" Lip available, must specify 1-1/2" Lip \$9.90.

14. Select door thickness **Price adjustment**

134	1-3/4"	Standard
Example 138	1-3/8" to 2-3/4", shims included (specify in 1/8" increments)	\$83.00

Accessories available, see pages 239–240. Accessories include Decorative plates, SUS A-KIT, etc.
 Credentials available, see pages 16–20.

CO-220 STANDALONE MORTISE

1-4. Select chassis/function

		Price
CO-220-MS-75	Classroom Security	\$2,546.00

Price includes (1) pre-paired Remote Lockdown Fob, p/n 24744856, shipped with lock.
Additional fobs available under [CO Series Accessories](#).

5. Select reader

(Note: CO Series readers are not interchangeable.)		Price adjustment
KP	Keypad	Standard
MS	Magnetic stripe (Swipe)	\$139.00
MSK	Magnetic stripe (Swipe) + keypad	\$229.00
PR	Proximity	\$235.00
PRK	Proximity + keypad	\$330.00

6. Select lever¹

		Price adjustment
LLL	Less interior and exterior levers	-\$89.60
Standard options	SPA (Sparta), RHO (Rhodes), ATH (Athens), TLR (Tubular), BRW (Broadway), BRK (Boardwalk), LAT (Latitude), LON (Longitude)	No charge

1. Tactile Warning use 8AT for Athens, 8RO for Rhodes, 8SP for Sparta and 8TR for Tubular. \$67.00 per lever. Applied to exterior lever only unless otherwise specified. Not available with 643e finish.

7. Select finish

		Price adjustment
626	Satin Chrome	No charge
605	Bright Brass	\$166.00
606	Satin Brass	\$166.00
612	Satin Bronze	\$166.00
619	Satin Nickel	\$166.00
625	Bright Chrome	\$166.00
643e	Aged Bronze	\$166.00
626AM	Satin Chrome Antimicrobial	\$215.00

8. Select cylinder type

		Price adjustment	
		Open	Restricted
<input type="checkbox"/> ● P6	With Cylinder, Schlage - (Everest 29 S123, 6-pin KIL standard)	No charge	\$30.00
<input type="checkbox"/> L	Less Cylinder, Schlage, Falcon, 6-pin KIL	-\$90.00	-\$90.00
<input type="checkbox"/> ● R	With Cylinder, Schlage 6-pin (Everest 29 S123 standard) FSIC	\$102.00	\$132.00
<input type="checkbox"/> J	Less Cylinder, Schlage, 6-pin FSIC	-\$55.00	-\$55.00
<input type="checkbox"/> ● G	With Cylinder, Schlage 7-pin (Everest 29R standard) (factory master keyed only) SFIC	N/A	\$113.00
<input type="checkbox"/> B	Less Cylinder, Schlage, Falcon, Competitive OEM's, 7-pin (SFIC)	-\$55.00	-\$55.00
<input type="checkbox"/> L-SAR	Less Cylinder, Sargent (10L + 11L), 6-pin KIL (Only RHO, 8RO, SPA, 8SP, TLR, 8TR, ATH, 8AT lever styles)	No charge	No charge
<input type="checkbox"/> L-CO6	Less Cylinder, Corbin, 6-pin KIL (Only RHO, 8RO, SPA, 8SP lever styles)	No charge	No charge
<input type="checkbox"/> J-SAR	Less Cylinder, Sargent 6300, 6-pin FSIC	No charge	No charge
<input type="checkbox"/> J-CO6	Less Cylinder, Corbin 8000, 6-pin FSIC	No charge	No charge
<input type="checkbox"/> J-CO7	Less Cylinder, Corbin 8000-7, 7-pin FSIC, (Only RHO, 8RO, SPA, 8SP, TLR and 8TR)	No charge	No charge
<input type="checkbox"/> J-MED	Less Cylinder, Medeco 32*0201, 6-pin FSIC (Only RHO, 8RO, SPA, 8SP lever styles)	No charge	No charge
<input type="checkbox"/> J-YA6	Less Cylinder, Yale 1210 or Medeco 31*0100, 6-pin FSIC	No charge	No charge
<input type="checkbox"/> J-YA7	Less Cylinder, Yale 1220, 7-pin FSIC (Only RHO, 8RO, SPA, 8SP lever styles)	No charge	No charge
<input type="checkbox"/> L-FA7	Less Cylinder, Falcon, 7-pin, KIL (Only RHO, 8RO, SPA, 8SP lever styles)	No charge	No charge

● Master Keyed cylinders can be specified and will be shipped in lock packaging. For Master Keying System Summary form which should accompany the master keyed order, see page 296.

△ For master keying, an additional charge of \$28.30 each applies. Specify line item 50-210.

□ Control keys for installation/removal of interchangeable cores are not furnished and must be ordered separate.

For additional assistance on Master Keying as well as restricted keyways, please contact customer service.



CO-220-MS-75-PR



CO-220-MS-75-PRK



CO-220-MS-75-MSK



CO-220-MS-75-MS



CO-220-MS-75-KP

CREDENTIALS

READERS

READER CONTROLLERS

MULTI-FAMILY

ENGAGE

AD SERIES

CO SERIES

ELECTROMAGNETIC LOCKS

POWER SUPPLIES

VON DUPRIN ACCESS CONTROL

SYSTEM ACC

MISC



CO-220 STANDALONE MORTISE

9. Select keying type **Price adjustment**

Open keyway families: KIL or FSIC ²		
S123	Everest 29 S (Key in Lever or FSIC)	Standard
C123	Everest C	No charge
C/CE/E/EF/F/FG/G	Classic Obverse	No charge
Restricted keyway families: KIL or FSIC ^{2,3}		
29T	Everest 29 T	\$30.00
D	Everest D	\$30.00
Classic Restricted	Quad, Numbered, Reverse	\$30.00
Restricted keyway families: SFIC ⁴		
29 R	Everest 29 R	No charge
B	Everest B	No charge

- Full size key systems (Everest 29 S and T, Everest C and D, Obverse and Quad) are available in Primus and Primus XP key system and must be ordered separately. Lock should be ordered less cylinder and Primus cylinder should be a separate line.
- Everest restricted keyways require a Letter of Authorization to be submitted with the order. See page 302 for sample Letter of Authorization.
- Master keyed cylinders can be specified and will be shipped in lock packaging. For Master Keying System Summary form which should accompany the master keyed order, see page 296.

10. Select handing (field reversible) **Price adjustment**

RH	Right handed	No charge
LH	Left handed	No charge
RHR	Right handed reverse	No charge
LHR	Left handed reverse	No charge

11. Select battery **Price adjustment**

4B	4AA Battery kit	Standard
----	-----------------	----------

12. Select mortise lock armor front **Price adjustment**

LLL	Less Armor Front	-\$25.00
09-663	1-1/4" Wide square corner, latch for MS	Standard
09-669	1-1/16" Wide square corner, latch, options for MS	No charge
09-666	1-1/4" Wide square corner, latch x deadbolt for MD	Standard
09-672	1-1/16" Wide square corner, latch x deadbolt, options for MD	No charge

13. Select strike plate **Price adjustment**

LLL	Less Strike	-\$18.40
10-072	1-1/4" x 4-7/8" Square corner + box; 1-3/16" lip length	Standard
10-072xx	1-1/4" x 4-7/8" Square corner + box; specify lip length (xx) as 1" or 1-1/2"	No charge
10-072xx	1-1/4" x 4-7/8" Square corner + box; specify lip length (xx) as 1-3/4"	\$45.00
10-075 ⁵	1/2" Rabbeted	\$155.00
37-015	Strike frame reinforcer, specify 37-015	No charge

- For 1-3/4" thick doors, use wide armor front. For over 1-3/4" thick door extended equally (EE) use 1-1/4" wide armor front.
- Extended lead time, consult customer service.

14. Select door thickness **Price adjustment**

134	1-3/4"	Standard
Example 138	1-3/8" to 2-3/4", Shims included (Specify in 1/8" increments)	\$83.00

Accessories available, see pages 239–240. Accessories include Decorative plates, SUS A-KIT, etc.
 Credentials available, see pages 16–20.

CO-220 STANDALONE
EXIT TRIM

1-3. Select chassis/exit trim type		(Note: See page 201 for exit device compatibility.)	Price
CO-220-993R	Exit Rim / Concealed Vertical Rod (Metal Door) / Concealed Vertical Cable (Metal Door)		\$2,803.00
CO-220-993M	Exit Mortise Lock		\$2,845.00

4. Select function		Price adjustment
75	Classroom/Security	Standard

5. Select reader		(Note: CO Series readers are not interchangeable.)	Price adjustment
KP	Keypad		No charge
MS	Magnetic stripe (Swipe)		\$139.00
MSK	Magnetic stripe (Swipe) + keypad		\$229.00
PR	Proximity		\$235.00
PRK	Proximity + keypad		\$330.00

6. Select lever ¹		Price adjustment
LLL	Less interior and exterior levers	-\$31.00
Standard options	SPA (Sparta), RHO (Rhodes), ATH (Athens), TLR (Tubular), BRW (Broadway), BRK (Boardwalk), LAT (Latitude), LON (Longitude)	No charge

1. Tactile Warning use 8AT for Athens, 8RO for Rhodes, 8SP for Sparta and 8TR for Tubular. \$67.00 per lever. Applied to exterior lever only unless otherwise specified. Not available with 643e finish.

6. Select finish		Price adjustment
626	Satin Chrome	No charge
605	Bright Brass	\$166.00
606	Satin Brass	\$166.00
612	Satin Bronze	\$166.00
619	Satin Nickel	\$166.00
625	Bright Chrome	\$166.00
643e	Aged Bronze	\$166.00
626AM	Satin Chrome Antimicrobial	\$215.00

7. Select cylinder type		Price adjustment	
		Open	Restricted
<input type="checkbox"/> ● P6	With Cylinder, Schlage - (Everest 29 S123, 6-pin KIL standard)	No charge	\$30.00
<input type="checkbox"/> L	Less Cylinder, Schlage, Falcon, 6-pin KIL	-\$90.00	-\$90.00
<input type="checkbox"/> ● R	With Cylinder, Schlage 6-pin (Everest 29 S123 standard) FSIC	\$102.00	\$132.00
<input type="checkbox"/> J	Less Cylinder, Schlage, 6-pin FSIC	-\$55.00	-\$55.00
<input type="checkbox"/> ● G	With Cylinder, Schlage 7-pin (Everest 29R standard) (factory master keyed only) SFIC	N/A	\$113.00
<input type="checkbox"/> B	Less Cylinder, Schlage, Falcon, Competitive OEM's, 7-pin (SFIC)	-\$55.00	-\$55.00
<input type="checkbox"/> L-SAR	Less Cylinder, Sargent (10L + 11L), 6-pin KIL (Only RHO, 8RO, SPA, 8SP, TLR, 8TR, ATH, 8AT lever styles)	No charge	No charge
<input type="checkbox"/> L-CO6	Less Cylinder, Corbin, 6-pin KIL (Only RHO, 8RO, SPA, 8SP lever styles)	No charge	No charge
<input type="checkbox"/> J-SAR	Less Cylinder, Sargent 6300, 6-pin FSIC	No charge	No charge
<input type="checkbox"/> J-CO6	Less Cylinder, Corbin 8000, 6-pin FSIC	No charge	No charge
<input type="checkbox"/> J-CO7	Less Cylinder, Corbin 8000-7, 7-pin FSIC, (Only RHO, 8RO, SPA, 8SP, TLR and 8TR)	No charge	No charge
<input type="checkbox"/> J-MED	Less Cylinder, Medeco 32*0201, 6-pin FSIC (Only RHO, 8RO, SPA, 8SP lever styles)	No charge	No charge
<input type="checkbox"/> J-YA6	Less Cylinder, Yale 1210 or Medeco 31*0100, 6-pin FSIC	No charge	No charge
<input type="checkbox"/> J-YA7	Less Cylinder, Yale 1220, 7-pin FSIC (Only RHO, 8RO, SPA, 8SP lever styles)	No charge	No charge
<input type="checkbox"/> L-FA7	Less Cylinder, Falcon, 7-pin, KIL (Only RHO, 8RO, SPA, 8SP lever styles)	No charge	No charge

● Master Keyed cylinders can be specified and will be shipped in lock packaging. For Master Keying System Summary form which should accompany the master keyed order, see page 296.

△ For master keying, an additional charge of \$28.30 each applies. Specify line item 50-210.

□ Control keys for installation/removal of interchangeable cores are not furnished and must be ordered separate.

For additional assistance on Master Keying as well as restricted keyways, please contact customer service.



CO-220-993R-75-MSK



CO-220-993R-75-MS



CO-220-993R-75-KP



CO-220-993R-75-PR



CO-220-993R-75-PRK

CREDENTIALS

READERS

READER CONTROLLERS

MULTI-FAMILY

ENGAGE

AD SERIES

CO SERIES

ELECTROMAGNETIC LOCKS

POWER SUPPLIES

VON DUPRIN ACCESS CONTROL

SYSTEM ACC

MISC



CO-220 STANDALONE EXIT TRIM

9. Select keying type **Price adjustment**

Open keyway families: KIL or FSIC ²		
S123	Everest 29 S (Key in Lever or FSIC)	Standard
C123	Everest C	No charge
C/CE/E/EF/F/FG/G	Classic Obverse	No charge
Restricted keyway families: KIL or FSIC ^{2,3}		
29T	Everest 29 T	\$30.00
D	Everest D	\$30.00
Classic Restricted	Quad, Numbered, Reverse	\$30.00
Restricted keyway families: SFIC ⁴		
29 R	Everest 29 R	No charge
B	Everest B	No charge

- Full Size key systems (Everest 29 S and T, Everest C and D, Obverse and Quad) are available in Primus and Primus XP key system and must be ordered separately. Lock should be ordered less cylinder and Primus cylinder should be a separate line.
- Everest Restricted Keyways require a Letter of Authorization to be submitted with the order. See page 302 for sample Letter of Authorization.
- Master Keyed cylinders can be specified and will be shipped in lock packaging. For Master Keying System Summary form which should accompany the master keyed order, see page 296.

10. Select handing (field reversible) **Price adjustment**

RHR	Right handed reverse	No charge
LHR	Left handed reverse	No charge

11. Select battery **Price adjustment**

4B	4AA Battery kit	Standard
----	-----------------	----------

12. – 13. No selection required**14. Select door thickness** **Price adjustment**

134	1-3/4"	Standard
Example 200	1-3/4" to 2-3/4", (Specify in 1/8" increments)	\$83.00

Accessories available, see pages 239–240. Accessories include Decorative plates, SUS A-KIT, etc.

Credentials available, see pages 16–20.

CO Series Non-Functioning "Dummy" Exit trim now available. Please see pages 235–236 for details.

CO Series Exit trim

The CO-220 Exit trim comes with a universal mounting plate and is compatible with the following exit devices:

- **Von Duprin 98/99 and 98/99XP**
 - Rim, Concealed Vertical Rod (metal door only), Concealed Vertical Cable (metal door only), Mortise
- **Von Duprin 22/22F**
 - Rim, Surface Vertical Rod
- **Falcon 25** – Rim
- **Sargent 80 Series** (Narrow design and reversible rim exits not compatible) – Rim
- **Corbin Russwin 5000 Series** – Rim
- **Yale 7000** – Rim
- **Dorma 9300** – Rim
- **Precision 21** – Rim (2100 converts to 21 with Precision's BP21 Kit)

CO-250 STANDALONE

CYLINDRICAL

1-4. Select chassis/function

CO-250-CY-70	Storeroom	\$1,906.00
CO-250-CY-50	Office/Classroom	\$1,916.00
CO-250-CY-40	Privacy	\$1,916.00

5. Select reader

(Note: CO Series readers are not interchangeable.)

Price adjustment

MS	Magnetic stripe (Swipe)	No charge
MSK	Magnetic stripe (Swipe) + keypad	\$229.00

6. Select lever¹
Price adjustment

LLL	Less each lever	-\$31.00
Standard options	SPA (Sparta), RHO (Rhodes), ATH (Athens), TLR (Tubular), BRW (Broadway), BRK (Boardwalk), LAT (Latitude), LON (Longitude)	No charge

1. Tactile Warning use 8AT for Athens, 8RO for Rhodes, 8SP for Sparta and 8TR for Tubular. \$67.00 per lever. Applied to exterior lever only unless otherwise specified. Not available with 643e finish.

7. Select finish
Price adjustment

626	Satin Chrome	No charge
605	Bright Brass	\$166.00
606	Satin Brass	\$166.00
612 ⁴	Satin Bronze	\$166.00
619	Satin Nickel	\$166.00
625	Bright Chrome	\$166.00
643e	Aged Bronze	\$166.00
626AM	Satin Chrome Antimicrobial	\$215.00

8. Select cylinder type
Price adjustment
Open Restricted

△ ● P6	With Cylinder, Schlage - (Everest 29 S123, 6-pin KIL standard)	No charge	\$30.00
L	Less Cylinder, Schlage, Falcon, 6-pin KIL	-\$90.00	-\$90.00
□ ● R	With Cylinder, Schlage 6-pin (Everest 29 S123 standard) FSIC	\$102.00	\$132.00
J	Less Cylinder, Schlage, 6-pin FSIC	-\$55.00	-\$55.00
□ ● G	With Cylinder, Schlage 7-pin (Everest 29R standard) (factory master keyed only) SFIC	N/A	\$113.00
B	Less Cylinder, Schlage, Falcon, Competitive OEM's, 7-pin (SFIC)	-\$55.00	-\$55.00
L-SAR	Less Cylinder, Sargent (10L + 11L), 6-pin KIL (Only RHO, 8RO, SPA, 8SP lever styles)	No charge	No charge
L-CO6	Less Cylinder, Corbin, 6-pin KIL (Only RHO, 8RO, SPA, 8SP lever styles)	No charge	No charge
J-SAR	Less Cylinder, Sargent 6300, 6-pin FSIC	No charge	No charge
J-CO6	Less Cylinder, Corbin 8000, 6-pin FSIC	No charge	No charge
J-CO7	Less Cylinder, Corbin 8000-7, 7-pin FSIC, (Only RHO, 8RO, SPA, 8SP, TLR and 8TR)	No charge	No charge
J-MED	Less Cylinder, Medeco 32*0201, 6-pin FSIC (Only RHO, 8RO, SPA, 8SP lever styles)	No charge	No charge
J-YA6	Less Cylinder, Yale 1210 or Medeco 31*0100, 6-pin FSIC	No charge	No charge
J-YA7	Less Cylinder, Yale 1220, 7-pin FSIC (Only RHO, 8RO, SPA, 8SP lever styles)	No charge	No charge
L-FA7	Less Cylinder, Falcon, 7-pin, KIL (Only RHO, 8RO, SPA, 8SP lever styles)	No charge	No charge

● Master Keyed cylinders can be specified and will be shipped in lock packaging. For Master Keying System Summary form which should accompany the master keyed order, see page 296.

△ For master keying, an additional charge of \$28.30 each applies. Specify line item 50-210.

□ Control keys for installation/removal of interchangeable cores are not furnished and must be ordered separate.

For additional assistance on Master Keying as well as restricted keyways, please contact customer service.



CO-250-CY-70-MS

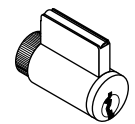
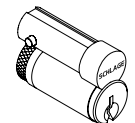

CO-250-CY-70-MSK

 Full Cylinder
 P6, L, L-SAR, L-FA7

 FSIC Format
 R, J, J-SAR, J-CO6,
 J-CO7, J-YA6

 SFIC Format
 B, G



CO-250 STANDALONE

CYLINDRICAL

9. Select keying type **Price adjustment**

Open keyway families: KIL or FSIC ²		
S123	Everest 29 S (Key in Lever or FSIC)	Standard
C123	Everest C	No charge
C/CE/E/EF/F/FG/G	Classic Obverse	No charge
Restricted keyway families: KIL or FSIC ^{2,3}		
29T	Everest 29 T	\$30.00
D	Everest D	\$30.00
Classic Restricted	Quad, Numbered, Reverse	\$30.00
Restricted keyway families: SFIC ⁴		
29 R	Everest 29 R	No charge
B	Everest B	No charge

2. Full Size key systems (Everest 29 S and T, Everest C and D, Obverse and Quad) are available in Primus and Primus XP key system and must be ordered separately. Lock should be ordered less cylinder and Primus cylinder should be a separate line.
3. Everest Restricted Keyways require a Letter of Authorization to be submitted with the order. See page 302 for sample Letter of Authorization.
4. Master Keyed cylinders can be specified and will be shipped in lock packaging. For Master Keying System Summary form which should accompany the master keyed order, see page 296.

10. Select handing (field reversible) **Price adjustment**

RH	Right handed	No charge
LH	Left handed	No charge
RHR	Right handed reverse	No charge
LHR	Left handed reverse	No charge

11. Select battery **Price adjustment**

4B	4AA Battery kit	Standard
----	-----------------	----------

12. Select backset and latch bolt **Price adjustment**

LLL	Less Latch	-\$51.00
13-247	2-3/4" Backset, deadlatch, square corner, 1-1/8" x 2-1/4"	Standard
14-049	2-3/4" Backset, deadlatch anti-friction fire door latch, square corner, 1-1/8" x 2-1/4", 3/4" throw	\$268.00
14-051	2-3/8" Backset, deadlatch, square corner, 1-1/8" x 2-1/4"	No charge
14-050	3-3/4" Backset, deadlatch, square corner, 1-1/8" x 2-1/4"	\$16.00
43-001	5" Backset extension link, deadlatch	\$47.00
39-030 ⁵	Rabbeted latch and strike kit, 605 and 626 only	\$85.00

5. Adapts square corner latch and 2-3/4" square corner strike to 1/2" rabbeted door and frame.

13. Select strike plate **Price adjustment**

LLL	Less Strike Plate	-\$6.60
10-025	1-3/16" Lip, ANSI, no box, 1-1/14" x 4-7/8"	Standard
10-013 ⁶	1-1/8" Lip, square corner, T-strike, box, 1-1/8" – 2-3/4"	No charge
10-016	1-1/8" Lip, square corner, T-strike, deep box, fire door latch	No charge
K510-066	Box for ANSI strike (Must be specific)	No charge

6. 1-1/2" Lip available, must specify 1-1/2" Lip \$9.90.

14. Select door thickness **Price adjustment**

134	1-3/4"	Standard
Example 138	1-3/8" to 2-3/4", Shims included (Specify in 1/8" increments)	\$83.00

Accessories including decorative plates, SUS A-KIT, etc. available, see pages 239–240.
 Credentials available, see pages 16–20.

CO-250 STANDALONE
MORTISE/MORTISE DEADBOLT

1-3. Select chassis/function

CO-250-MS	Mortise	\$2,257.00
CO-250-MD	Mortise Deadbolt	\$2,353.00

4. Select function
Price adjustment

70	Storeroom (Not available on Mortise Deadbolt)	Standard
50	Office/Classroom (Not available on Mortise Deadbolt)	\$10.00
40 ¹	Privacy	\$10.00

1. Inside Push Button (IPB) only included with Mortise (MS) chassis. Mortise Deadbolt (MD) chassis comes with LED indicator only. \$10.00 charge does not apply to Mortise Deadbolt (MD) chassis.

5. Select reader

(Note: CO Series readers are not interchangeable.)

Price adjustment

MS	Magnetic stripe (Swipe)	No charge
MSK	Magnetic stripe (Swipe) + keypad	\$229.00

6. Select lever²
Price adjustment

LLL	Less interior and exterior levers	-\$89.60
Standard options	SPA (Sparta), RHO (Rhodes), ATH (Athens), TLR (Tubular), BRW (Broadway), BRK (Boardwalk), LAT (Latitude), LON (Longitude)	No charge

2. Tactile Warning use 8AT for Athens, 8RO for Rhodes, 8SP for Sparta and 8TR for Tubular. \$67.00 per lever. Applied to exterior lever only unless otherwise specified. Not available with 643e finish.

7. Select finish
Price adjustment

626	Satin Chrome	No charge
605	Bright Brass	\$166.00
606	Satin Brass	\$166.00
612	Satin Bronze	\$166.00
619	Satin Nickel	\$166.00
625	Bright Chrome	\$166.00
643e	Aged Bronze	\$166.00
626AM	Satin Chrome Antimicrobial	\$215.00

8. Select cylinder type
Price adjustment
Open Restricted

<input checked="" type="checkbox"/> ● P6	With Cylinder, Schlage - (Everest 29 S123, 6-pin KIL standard)	No charge	\$30.00
L	Less Cylinder, Schlage, Falcon, 6-pin KIL	-\$90.00	-\$90.00
<input type="checkbox"/> ● R	With Cylinder, Schlage 6-pin (Everest 29 S123 standard) FSIC	\$102.00	\$132.00
J	Less Cylinder, Schlage, 6-pin FSIC	-\$55.00	-\$55.00
<input type="checkbox"/> ● G	With Cylinder, Schlage 7-pin (Everest 29R standard) (factory master keyed only) SFIC	N/A	\$113.00
B	Less Cylinder, Schlage, Falcon, Competitive OEM's, 7-pin (SFIC)	-\$55.00	-\$55.00
L-SAR	Less Cylinder, Sargent (10L + 11L), 6-pin KIL (Only RHO, 8RO, SPA, 8SP, TLR, 8TR, ATH, 8AT lever styles)	No charge	No charge
L-CO6	Less Cylinder, Corbin, 6-pin KIL (Only RHO, 8RO, SPA, 8SP lever styles)	No charge	No charge
J-SAR	Less Cylinder, Sargent 6300, 6-pin FSIC	No charge	No charge
J-CO6	Less Cylinder, Corbin 8000, 6-pin FSIC	No charge	No charge
J-CO7	Less Cylinder, Corbin 8000-7, 7-pin FSIC, (Only RHO, 8RO, SPA, 8SP, TLR and 8TR)	No charge	No charge
J-MED	Less Cylinder, Medeco 32*0201, 6-pin FSIC (Only RHO, 8RO, SPA, 8SP lever styles)	No charge	No charge
J-YA6	Less Cylinder, Yale 1210 or Medeco 31*0100, 6-pin FSIC	No charge	No charge
J-YA7	Less Cylinder, Yale 1220, 7-pin FSIC (Only RHO, 8RO, SPA, 8SP lever styles)	No charge	No charge
L-FA7	Less Cylinder, Falcon, 7-pin, KIL (Only RHO, 8RO, SPA, 8SP lever styles)	No charge	No charge

- Master Keyed cylinders can be specified and will be shipped in lock packaging. For Master Keying System Summary form which should accompany the master keyed order, see page 296.

△ For master keying, an additional charge of \$28.30 each applies. Specify line item 50-210.

Control keys for installation/removal of interchangeable cores are not furnished and must be ordered separate.

For additional assistance on Master Keying as well as restricted keyways, please contact customer service.



CO-250-MS-70-MSK

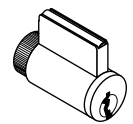
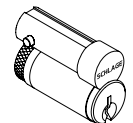

CO-250-MS-70-MS

 Full Cylinder
P6, L, L-SAR, L-FA7

 FSIC Format
R, J, J-SAR, J-CO6,
J-CO7, J-YA6

 SFIC Format
B, G



CO-250 STANDALONE MORTISE/MORTISE DEADBOLT

9. Select keying type **Price adjustment**

Open keyway families: KIL or FSIC ³		
S123	Everest 29 S (Key in Lever or FSIC)	Standard
C123	Everest C	No charge
C/CE/E/EF/F/FG/G	Classic Obverse	No charge
Restricted keyway families: KIL or FSIC ^{3,4}		
29T	Everest 29 T	\$30.00
D	Everest D	\$30.00
Classic Restricted	Quad, Numbered, Reverse	\$30.00
Restricted keyway families: SFIC ⁵		
29 R	Everest 29 R	No charge
B	Everest B	No charge

3. Full size key systems (Everest 29 S and T, Everest C and D, Obverse and Quad) are available in Primus and Primus XP key system and must be ordered separately. Lock should be ordered less cylinder and Primus cylinder should be a separate line.
4. Everest restricted keyways require a Letter of Authorization to be submitted with the order. See page 302 for sample Letter of Authorization.
5. Master keyed cylinders can be specified and will be shipped in lock packaging. For Master Keying System Summary form which should accompany the master keyed order, see page 296.

10. Select handing (field reversible) **Price adjustment**

RH	Right handed	No charge
LH	Left handed	No charge
RHR	Right handed reverse	No charge
LHR	Left handed reverse	No charge

11. Select battery **Price adjustment**

4B	4AA Battery kit	Standard
----	-----------------	----------

12. Select mortise lock armor front **Price adjustment**

LLL	Less Armor Front	-\$25.00
09-663	1-1/4" Wide square corner, latch for MS	Standard
09-669	1-1/16" Wide square corner, latch, options for MS	No charge
09-666	1-1/4" Wide square corner, latch x deadbolt for MD	Standard
09-672	1-1/16" Wide square corner, latch x deadbolt, options for MD	No charge

13. Select strike plate **Price adjustment**

LLL	Less Strike	-\$18.40
10-072	1-1/4" x 4-7/8" Square corner + box; 1-3/16" lip length	Standard
10-072xx	1-1/4" x 4-7/8" Square corner + box; specify lip length (xx) as 1" or 1-1/2"	No charge
10-072xx	1-1/4" x 4-7/8" Square corner + box; specify lip length (xx) as 1-3/4"	\$45.00
10-075 ⁵	1/2" Rabbeted	\$155.00
37-015	Strike frame reinforcer, specify 37-015	No charge

6. For 1-3/4" thick doors, use wide armor front. For over 1-3/4" thick door extended equally (EE) use 1-1/4" wide armor front.
 ⚠ Extended lead time, consult customer service.

14. Select door thickness **Price adjustment**

134	1-3/4"	Standard
Example 138	1-3/8" to 2-3/4", Shims included (Specify in 1/8" increments)	\$83.00

Accessories available, see pages 239–240. Accessories include Decorative plates, SUS A-KIT, etc.
 Credentials available, see pages 16–20.

CO-250 STANDALONE

EXIT TRIM



1-3. Select chassis/exit trim type		(Note: See page 201 for exit device compatibility.)	Price
CO-250-993R	Exit Rim / Concealed Vertical Rod (Metal Door) / Concealed Vertical Cable (Metal Door)		\$2,473.00
CO-250-993S	Exit Surface Vertical Rod		\$2,512.00
CO-250-993M	Exit Mortise Lock		\$2,512.00



CO-250-993R-70-MS

4. Select function		Price adjustment
70	Storeroom	Standard

5. Select reader		(Note: CO Series readers are not interchangeable.)	Price adjustment
MS	Magnetic stripe (Swipe)		No charge
MSK	Magnetic stripe (Swipe) + keypad		\$229.00



CO-250-993R-70-MSK

6. Select lever ¹		Price adjustment
LLL	Less interior and exterior levers	-\$31.00
Standard options	SPA (Sparta), RHO (Rhodes), ATH (Athens), TLR (Tubular), BRW (Broadway), BRK (Boardwalk), LAT (Latitude), LON (Longitude)	No charge

1. Tactile Warning use 8AT for Athens, 8RO for Rhodes, 8SP for Sparta and 8TR for Tubular. \$67.00 per lever. Applied to exterior lever only unless otherwise specified. Not available with 643e finish.

6. Select finish		Price adjustment
626	Satin Chrome	No charge
605	Bright Brass	\$166.00
606	Satin Brass	\$166.00
612	Satin Bronze	\$166.00
619	Satin Nickel	\$166.00
625	Bright Chrome	\$166.00
643e	Aged Bronze	\$166.00
626AM	Satin Chrome Antimicrobial	\$215.00

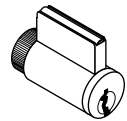
 Full Cylinder
P6, L, L-SAR, L-FA7

7. Select cylinder type		Price adjustment	
		Open	Restricted
△ ● P6	With Cylinder, Schlage - (Everest 29 S123, 6-pin KIL standard)	No charge	\$30.00
L	Less Cylinder, Schlage, Falcon, 6-pin KIL	-\$90.00	-\$90.00
□ ● R	With Cylinder, Schlage 6-pin (Everest 29 S123 standard) FSIC	\$102.00	\$132.00
J	Less Cylinder, Schlage, 6-pin FSIC	-\$55.00	-\$55.00
□ ● G	With Cylinder, Schlage 7-pin (Everest 29R standard) (factory master keyed only) SFIC	N/A	\$113.00
B	Less Cylinder, Schlage, Falcon, Competitive OEM's, 7-pin (SFIC)	-\$55.00	-\$55.00
L-SAR	Less Cylinder, Sargent (10L + 11L), 6-pin KIL (Only RHO, 8RO, SPA, 8SP, TLR, 8TR, ATH, 8AT lever styles)	No charge	No charge
L-CO6	Less Cylinder, Corbin, 6-pin KIL (Only RHO, 8RO, SPA, 8SP lever styles)	No charge	No charge
J-SAR	Less Cylinder, Sargent 6300, 6-pin FSIC	No charge	No charge
J-CO6	Less Cylinder, Corbin 8000, 6-pin FSIC	No charge	No charge
J-CO7	Less Cylinder, Corbin 8000-7, 7-pin FSIC, (Only RHO, 8RO, SPA, 8SP, TLR and 8TR)	No charge	No charge
J-MED	Less Cylinder, Medeco 32*0201, 6-pin FSIC (Only RHO, 8RO, SPA, 8SP lever styles)	No charge	No charge
J-YA6	Less Cylinder, Yale 1210 or Medeco 31*0100, 6-pin FSIC	No charge	No charge
J-YA7	Less Cylinder, Yale 1220, 7-pin FSIC (Only RHO, 8RO, SPA, 8SP lever styles)	No charge	No charge
L-FA7	Less Cylinder, Falcon, 7-pin, KIL (Only RHO, 8RO, SPA, 8SP lever styles)	No charge	No charge

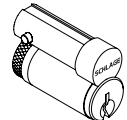
 FSIC Format
R, J, J-SAR, J-CO6,
J-CO7, J-YA6

 SFIC Format
B, G

● Master Keyed cylinders can be specified and will be shipped in lock packaging. For Master Keying System Summary form which should accompany the master keyed order, see page 296.

△ For master keying, an additional charge of \$28.30 each applies. Specify line item 50-210.

□ Control keys for installation/removal of interchangeable cores are not furnished and must be ordered separate.

For additional assistance on Master Keying as well as restricted keyways, please contact customer service.



CO-250 STANDALONE EXIT TRIM

9. Select keying type		Price adjustment
Open keyway families: KIL or FSIC²		
S123	Everest 29 S (Key in Lever or FSIC)	Standard
C123	Everest C	No charge
C/CE/E/EF/F/FG/G	Classic Obverse	No charge
Restricted keyway families: KIL or FSIC^{2,3}		
29T	Everest 29 T	\$30.00
D	Everest D	\$30.00
Classic Restricted	Quad, Numbered, Reverse	\$30.00
Restricted keyway families: SFIC⁴		
29 R	Everest 29 R	No charge
B	Everest B	No charge

2. Full Size key systems (Everest 29 S and T, Everest C and D, Obverse and Quad) are available in Primus and Primus XP key system and must be ordered separately. Lock should be ordered less cylinder and Primus cylinder should be a separate line.
3. Everest Restricted Keyways require a Letter of Authorization to be submitted with the order. See page 302 for sample Letter of Authorization.
4. Master Keyed cylinders can be specified and will be shipped in lock packaging. For Master Keying System Summary form which should accompany the master keyed order, see page 296.

10. Select handing (field reversible)		Price adjustment
RHR	Right handed reverse	No charge
LHR	Left handed reverse	No charge

11. Select battery		Price adjustment
4B	4AA Battery kit	Standard

12. – 13. No selection required

14. Select door thickness		Price adjustment
134	1-3/4"	Standard
Example 200	1-3/4" to 2-3/4", (Specify in 1/8" increments)	\$83.00

Accessories available, see pages 239–240. Accessories include Decorative plates, SUS A-KIT, etc.

Credentials available, see pages 16–20.

CO Series Non-Functioning "Dummy" Exit trim now available. Please see pages 235–236 for details.

CO Series Exit trim

The CO Series Exit trim comes with a universal mounting plate and is compatible with the following exit devices:

- **Von Duprin 98/99 and 98/99XP**
 - Rim, Concealed Vertical Rod (metal door only), Concealed Vertical Cable (metal door only), Surface Vertical Rod, Mortise
- **Von Duprin 22/22F**
 - Rim, Surface Vertical Rod
- **Falcon 25** – Rim
- **Sargent 80 Series** (Narrow design and reversible rim exits not compatible) – Rim
- **Corbin Russwin 5000 Series** – Rim
- **Yale 7000** – Rim
- **Dorma 9300** – Rim
- **Precision 21** – Rim (2100 converts to 21 with Precision's BP21 Kit)

CO-993DT

NON-FUNCTIONING DUMMY EXIT TRIM



1-3. Select chassis/exit trim type	(Note: See page 201 for exit device compatibility.)	Price
CO-993DT	Dummy Trim with Dummy Reader Cover and CO-100/200/250 Interior Escutcheon for Exit Rim / Concealed Vertical Rod ¹ / Concealed Vertical Cable ¹ / Surface Vertical Rod / Mortise Lock	\$1,120.00

1. Metal door only.

4. Select lever ²		Price adjustment
LLL	Less interior and exterior levers	-\$31.00
SPA	Sparta	No charge
RHO	Rhodes	No charge
ATH	Athens	No charge
TLR	Tubular	No charge
BRW	Broadway	No charge
BRK	Boardwalk	No charge
LAT	Latitude	No charge
LON	Longitude	No charge

2. Tactile Warning use 8AT for Athens, 8RO for Rhodes, 8SP for Sparta and 8TR for Tubular. \$67.00 per lever. Applied to exterior lever only unless otherwise specified. Not available with 643e finish.

5. Select finish		Price adjustment
626	Satin Chrome	No charge
605	Bright Brass	\$166.00
606	Satin Brass	\$166.00
612	Satin Bronze	\$166.00
619	Satin Nickel	\$166.00
625	Bright Chrome	\$166.00
643e	Aged Bronze	\$166.00
626AM	Satin Chrome Antimicrobial	\$215.00

6. Select cylinder type		Price adjustment	
		Open	Restricted
△ ● P6	With Cylinder, Schlage - (Everest 29 S123, 6-pin KIL standard)	No charge	\$30.00
L	Less Cylinder, Schlage, Falcon, 6-pin KIL	-\$90.00	-\$90.00
□ ● R	With Cylinder, Schlage 6-pin (Everest 29 S123 standard) FSIC	\$102.00	\$132.00
J	Less Cylinder, Schlage, 6-pin FSIC	-\$55.00	-\$55.00
□ ● G	With Cylinder, Schlage 7-pin (Everest 29R standard) (factory master keyed only) SFIC	N/A	\$113.00
B	Less Cylinder, Schlage, Falcon, Competitive OEM's, 7-pin (SFIC)	-\$55.00	-\$55.00
L-SAR	Less Cylinder, Sargent (10L + 11L), 6-pin KIL (Only RHO, 8RO, SPA, 8SP, TLR, 8TR, ATH, 8AT lever styles)	No charge	No charge
L-CO6	Less Cylinder, Corbin, 6-pin KIL (Only RHO, 8RO, SPA, 8SP lever styles)	No charge	No charge
J-SAR	Less Cylinder, Sargent 6300, 6-pin FSIC	No charge	No charge
J-CO6	Less Cylinder, Corbin 8000, 6-pin FSIC	No charge	No charge
J-CO7	Less Cylinder, Corbin 8000-7, 7-pin FSIC, (Only RHO, 8RO, SPA, 8SP, TLR and 8TR)	No charge	No charge
J-MED	Less Cylinder, Medeco 32*0201, 6-pin FSIC (Only RHO, 8RO, SPA, 8SP lever styles)	No charge	No charge
J-YA6	Less Cylinder, Yale 1210 or Medeco 31*0100, 6-pin FSIC	No charge	No charge
J-YA7	Less Cylinder, Yale 1220, 7-pin FSIC (Only RHO, 8RO, SPA, 8SP lever styles)	No charge	No charge
L-FA7	Less Cylinder, Falcon, 7-pin, KIL (Only RHO, 8RO, SPA, 8SP lever styles)	No charge	No charge

● Master Keyed cylinders can be specified and will be shipped in lock packaging. For Master Keying System Summary form which should accompany the master keyed order, see page 296.

△ For master keying, an additional charge of \$28.30 each applies. Specify line item 50-210.

□ Control keys for installation/removal of interchangeable cores are not furnished and must be ordered separate.

For additional assistance on Master Keying as well as restricted keyways, please contact customer service.

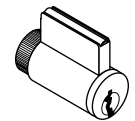
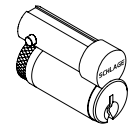

CO-993DT

 Full Cylinder
P6, L, L-SAR, L-FA7

 FSIC Format
R, J, J-SAR, J-CO6,
J-CO7, J-YA6

 SFIC Format
B, G



CO-993DT

NON-FUNCTIONING DUMMY TRIM FOR EXIT

7. Select keying type		Price adjustment
Open keyway families: KIL or FSIC³		
S123	Everest 29 S (Key in Lever or FSIC)	Standard
C123	Everest C	No charge
C/CE/E/EF/F/FG/G	Classic Obverse	No charge
Restricted keyway families: KIL or FSIC^{3,4}		
29T	Everest 29 T	\$30.00
D	Everest D	\$30.00
Classic Restricted	Quad, Numbered, Reverse	\$30.00
Restricted keyway families: SFIC⁵		
29 R	Everest 29 R	No charge
B	Everest B	No charge

3. Full Size key systems (Everest 29 S and T, Everest C and D, Obverse and Quad) are available in Primus and Primus XP key system and must be ordered separately. Lock should be ordered less cylinder and Primus cylinder should be a separate line.
4. Everest Restricted Keyways require a Letter of Authorization to be submitted with the order. See page 302 for sample Letter of Authorization.
5. Master Keyed cylinders can be specified and will be shipped in lock packaging. For Master Keying System Summary form which should accompany the master keyed order, see page 296.

8. Select handing (field reversible)		Price adjustment
RHR	Right handed reverse	No charge
LHR	Left handed reverse	No charge

9. – 10. No selection required

11. Select door thickness		Price adjustment
134	1-3/4"	Standard
Example 200	1-3/4" to 2-3/4", (Specify in 1/8" increments)	\$83.00

Accessories available, see pages 239–240. Accessories include Decorative plates, SUS A-KIT, etc.
 Credentials available, see pages 16–20.

CO Series Exit trim

The CO Series Exit trim comes with a universal mounting plate and is compatible with the following exit devices:

- **Von Duprin 98/99 and 98/99XP**
 - Rim, Concealed Vertical Rod (metal door only), Concealed Vertical Cable (metal door only), Mortise, Surface Vertical Rod (CO-100, CO-200 and CO-250 only)
- **Von Duprin 22/22F**
 - Rim, Surface Vertical Rod
- **Falcon 25** – Rim
- **Sargent 80 Series** (Narrow design and reversible rim exits not compatible) – Rim
- **Corbin Russwin 5000 Series** – Rim
- **Yale 7000** – Rim
- **Dorma 9300** – Rim
- **Precision 21** – Rim (2100 converts to 21 with Precision's BP21 Kit)

CT5000

The CT5000 is an indoor, offline single opening controller. It is flexible and works with various card reader technologies. With the correct power supply, the CT5000 controller works with various types of locking hardware, including electric strikes, electro-magnetic locks, or EL exit devices.

If networked functionality is required in the future, the CT5000 can be upgraded to a WRI-400 by upgrading the firmware and adding one incremental piece of hardware. This provides greater adaptability in the field.

Perimeter Door Application

The CT5000 can be used for perimeter door applications with an automatic operator, electric strike and card reader

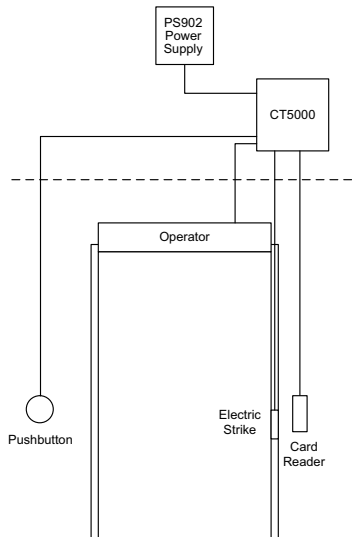

Narrow Stile Application

For narrow stile applications the CT5000 can be used with an electric strike and card reader

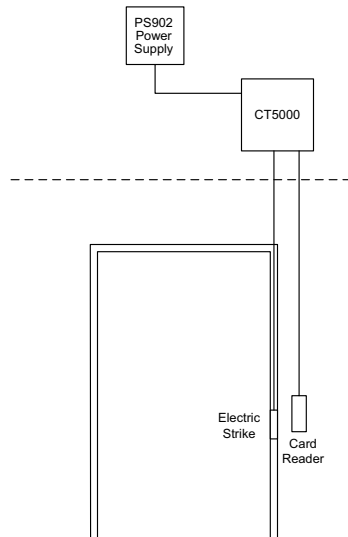

Panic Device Application

The CT5000 and a card reader along with the Von Duprin 914 Power Supply can control two EL exit devices for double door applications

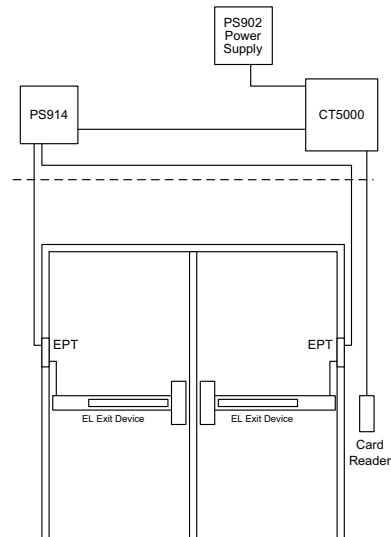

Note: All hardware shown above including exit devices, electric strikes, auto operators, power supplies, push buttons, etc. are sold separately.

Certifications

- UL 294
- Canada UL
- FCC Part 15
- Canada RSS – 210
- RoHS



CT5000 OFFLINE CONTROLLER

FEATURES

Features

- Supports up to 5000 users and audits
- Comes standard with 15 foot USB remote cable connector
- Programmed using Schlage Handheld Device (HHD) via USB connection or with SUS A-KIT and Schlage Utility Software Android™ app
- Power is hardwired
- Three form C relay outputs (for strike, auxiliary, and alarm)
- Supports Request-to-Exit (remote release) and Door Position Switch input.
- Card functions supported: normal, toggle, freeze, pass through, construction, lock down, and all card plus PIN applications
- Multiple reader technologies and positions on both sides of the gate/ door
- Internal LED visual indicators (Including low battery and state of the relay)
- Compatible with Schlage Express

Credential compatibility

- Magnetic stripe: field configurable track 1, 2, or 3
- Compatible with Schlage, Xceed ID™, AWID®, HID®, GE/CASI ProxLite®
- 125 kHz Proximity cards: 26a, 34x, 35x, 37x bit formats (reader dependant)
- 13.56 MHz Smart card: 26a,34x, 35x, 37x, 40x, 48x bit format (reader dependant)
- Can read card serial number of Mifare DESfire (reader dependant)

The following readers are UL294 listed for use with the CT5000:

- Essex Electronics model KTP-162
- Mercury Security models MR-5 and MR-20
- Schlage (previously XceedID) models PR10, SM10, MT11, MT15, MTK15

CT5000 OFFLINE CONTROLLER		
Product ID	Product Description	Price
CT5000	Offline controller (15 ft. USB cable standard)	\$1,264.00
23745565	125 ft. USB cable for CT5000 (optional)	\$174.90
PS-902	2 Amp power supply (required)	See page 271
SUS A-KIT	Schlage utility software programming cable (required)	See page 175

PARTS AND ACCESSORIES

ANDROID™ CABLE (For use with SUS Android App)			
Product description	Product specification	Specify	Price
USB & 2-PIN Android cable	Used to connect Android device to USB and 2-PIN locks and accessories	47282796 SUS A-KIT	See page 175

HANDHELD DEVICE ACCESSORIES (Legacy Product Support)			
Product description	Product specification	Specify	Price
Serial cable	Used to connect current model HHD (BM170) directly to legacy serial products without the need of a CIP	HH-2PIN SERIAL	\$218.00
Serial cable ¹	Used to connect previous model HHD (BM150) with CIP to program serial products	HH-SERIAL	\$195.00
Null converter	Used to connect Handheld Device to WA Series PIM, using HH-SERIAL serial cable (compatible to current and previous model HHDs)	PIMWA-CV	\$40.00
Computer interface module (CIP) ¹	Used to program serial products using HH-SERIAL serial cable	P512112	\$507.00
CIP with iButton reader ¹	Used to program serial products using HH-SERIAL serial cable	P101203	\$535.00

1. Not compatible to current HHD (BM170)

READER MODULE ACCESSORIES		
Product description	Specify	Price
Magnetic stripe cleaning cards	510310	See page 243

BATTERY HOLDER AND COVER KIT (Select by Chassis Type)		Available finishes									
		605	606	612	613	619	622	625	626	643e	626AM
Chassis type	Description	Specify		Price							
		Part number	Finish								
Cylindrical	Battery holder kit (Includes 4AA battery holder with cable, 4AA battery strap, (2) battery strap screws, 4AA battery cover, cover screw, Torx® cover screw)	4B-CM (23599202)	.[Finish]	See page 256							
Mortise	Battery holder kit (Includes 4AA battery holder with cable, 4AA battery strap, (2) battery strap screws, 4AA battery cover, cover screw, Torx cover screw)	4B-CM (23599202)	.[Finish]								
Exit	Battery holder kit (Includes 4AA battery holder with cable, 4AA battery strap, (2) battery strap screws, 4AA battery cover, cover screw, Torx cover screw)	4B-E (23599285)	.[Finish]								

SHIM PLATES		
Description	Specify	Price
Interior shim plate	23599368	See page 256
Exterior shim plate	23458599	
Note: Device is 0.063" thick.		

INSTALLATION TOOLS		
Product description	Specify	Price
Universal clamp ²	40-286	\$662.00
CO Series Mortise lock installation template	40-289	\$1,541.00
Universal Mortise door position switch (DPS) installation template	40-291	\$215.00
CO Series Cylindrical lock installation template	40-290	\$1,541.00
Universal Cylindrical door position switch (DPS) installation template	40-292	\$217.00

2. The universal clamp above is necessary when using the remaining products to ensure hole placement accuracy. The "Universal" (Clamp and DPS) products are for use in all CO, AD and LE product installations.

PARTS AND ACCESSORIES

DECORATIVE PLATE (Select by Size)		Available finishes									
		605 ³	606	612	613	619	622	625	626	643e ³	626AM
		▪ N/A N/A N/A N/A N/A N/A N/A ▪ ▪ N/A									
Size	Description	Specify		Price							
		Part number	Finish								
1.5" x 3.25" x .105"	Decorative plate (with screws) - (Exit trim)	23631823	.[Finish]	See page 255							
1.7" x 3.5" x .075"	Decorative plate (with screws)	23760267	.[Finish]								
3.2" x 3.5" x .075"	Decorative plate (with screws)	23760283	.[Finish]								
6.0" x 3.5" x .075"	Decorative plate (with screws)	23760317	.[Finish]								
6.6" x 3.5" x .075"	Decorative plate (with screws)	23760325	.[Finish]								
8.0" x 3.5" x .075"	Decorative plate (with screws)	23760309	.[Finish]								
8.0" x 3.5" x .075"	Decorative plate (with screws and welded standoff)	23760291	.[Finish]								
10.5" x 3.5" x .075"	Decorative plate (no screws necessary) - (under lock) ⁴	23760259	.[Finish]								
12.0" x 3.5" x .075"	Decorative plate (no screws necessary) - (under lock) ⁴	23760275	.[Finish]								

3. 626 Satin Chrome finish standard. Please consult Customer Care for 605 Bright Brass or 643E Aged Bronze.
4. Please consider overall Door Thickness when ordering.
5. Single Decorative plate. Interior and Exterior Decorative plates may be required.
6. Decorative plates may have multiple applications. Please see AD Series Retrofit Template Overlay guide at www.schlage.com/support for more information.

CO-200 STANDALONE ACCESSORIES			
Express level software package (Note: Refer to Software Levels Data sheet for features and details)			
Product description	Product specification	Specify	Price
Express offline lock software	Recommended for offline locks of fewer than 1000 users and/or 100 access points. Reporting of last 1000 events capability will retrieve audit trails. Must be installed on a computer that meets the minimum requirements (refer to software data sheet)	SXPR-SFT-1	\$711.00
Express level software package accessories			
Product description	Product specification	Specify	Price
Express computer interface module	Used to program legacy CM/CL/KC products, using HH-SERIAL serial cable	P512112	\$507.00
Express computer interface module (with iButton)	Used to connect PC/laptop to access device	P101203	\$535.00
Express female to female serial cable	Used to connect P101203 Computer Interface Module to PC/laptop	P394548	\$100.00
Express male DB9 to USB 6" cable adapter	Used to connect a USB Port device to a Serial Port device	SDB9USBCBL	\$157.00
Express magnetic stripe enrollment reader	-	CRM2	\$1,054.00
Express proximity enrollment reader	-	CRP2	\$850.00
Express Installation and training			
Product description	Product specification	Specify	Price
Express installation and training	Includes software installation and training. Provided by Allegion Security and Safety Consultant remotely from factory. (No discounts apply)	SCH-EXP-INST	\$649.00

CO-220 CLASSROOM LOCKDOWN ACCESSORIES			
Product description	Product specification	Specify	Price
Remote lockdown fob	Can be paired with up to ten locks	24744856	\$210.00

CO-250 STANDALONE ACCESSORIES			
Product description	Product specification	Specify	Price
Campus lock magnetic stripe encoder	ISO compatible high/low coercivity with female/male serial cable.	CL-ENCODER-2	\$6,788.00

STANDALONE LOCKS PARTS

Contents

Reader module with exterior escutcheon	242
Keypad membrane	243
Magnetic swipe cleaning cards	243
Interior escutcheons	243
Interior baseplate gasket	243
Exterior escutcheon	244
Exterior gasket kit.....	244
Interior baseplate subassembly.....	244
Exit device mounting hardware kit	244
Exterior spring cage.....	245
Tailpiece.....	246
Cylinders.....	248
Latches	249
Levers.....	249
Interior rose	253
Deadbolt thumb turn assembly	253
Lock retrator.....	253
Strikes	254
Mortise armor front.....	255
Decorative plates.....	255
Door thickness kit.....	256
Battery holder and cover kit	256
Shim plates	256
Miscellaneous.....	257

Finish codes and descriptions

BHMA code	Description
605	Bright brass
606	Satin brass
612	Satin bronze
619	Satin nickel
625	Bright chromium plated
626	Satin chrome
626AM	Satin stainless steel, antimicrobial
643e	Aged bronze

Customer service

- Order status
- Credit returns of non-defective products
- General sales questions

USA Allegion_Orders@allegion.com
 CAN Canada.CustomerService@allegion.com

Technical support

- Technical questions/issues
- Returns of defective products
- Repairs

USA Electronic_Lock_TechProdSupport@allegion.com
 CAN Canada.TechServices@allegion.com

PARTS AND ACCESSORIES

READER MODULE (WITH EXTERIOR ESCUTCHEON) (Select by Chassis, Class, Reader Technology)		Available finishes									
		605	606	612	613	619	622	625	626	643e	626AM
		▪	▪	▪	N/A	▪	N/A	▪	▪	▪	▪
Cylindrical		Specify									
Description	Part number	Function	Finish	Cylinder type	Price						
CO-100, Keypad only reader module	EXT-CO-100-CY-xx-KP	.[Function]	.[Finish]	.[Cylinder]	\$687.00						
CO-200, Keypad only reader module	EXT-CO-200-CY-xx-KP	.[Function]	.[Finish]	.[Cylinder]	\$1,013.00						
CO-200, Magnetic stripe (Swipe) reader module - (Track 1, 2, or 3)	EXT-CO-200-CY-xx-MS	.[Function]	.[Finish]	.[Cylinder]	\$1,198.00						
CO-200, Magnetic stripe (Swipe) with keypad reader module - (Track 1, 2, or 3)	EXT-CO-200-CY-xx-MSK	.[Function]	.[Finish]	.[Cylinder]	\$1,315.00						
CO-200, Proximity reader module - (125 kHz Proximity)	EXT-CO-200-CY-xx-PR	.[Function]	.[Finish]	.[Cylinder]	\$1,315.00						
CO-200, Proximity with keypad reader module - (125 kHz Proximity)	EXT-CO-200-CY-xx-PRK	.[Function]	.[Finish]	.[Cylinder]	\$1,438.00						
CO-250, Magnetic stripe (Swipe) reader module - (Track 1, 2, or 3)	EXT-CO-250-CY-xx-MS	.[Function]	.[Finish]	.[Cylinder]	\$1,198.00						
CO-250, Magnetic stripe (Swipe) with keypad reader module - (Track 1, 2, or 3)	EXT-CO-250-CY-xx-MSK	.[Function]	.[Finish]	.[Cylinder]	\$1,315.00						
Mortise											
CO-100, Keypad only reader module	EXT-CO-100-MS-xx-KP	.[Function]	.[Finish]	.[Cylinder]	\$743.00						
CO-200, Keypad only reader module	EXT-CO-200-MS-xx-KP	.[Function]	.[Finish]	.[Cylinder]	\$1,074.00						
CO-200, Magnetic stripe (Swipe) reader module - (Track 1, 2, or 3)	EXT-CO-200-MS-xx-MS	.[Function]	.[Finish]	.[Cylinder]	\$1,254.00						
CO-200, Magnetic stripe (Swipe) with keypad reader module - (Track 1, 2, or 3)	EXT-CO-200-MS-xx-MSK	.[Function]	.[Finish]	.[Cylinder]	\$1,373.00						
CO-200, Proximity reader module - (125 kHz Proximity)	EXT-CO-200-MS-xx-PR	.[Function]	.[Finish]	.[Cylinder]	\$1,373.00						
CO-200, Proximity with keypad reader module - (125 kHz Proximity)	EXT-CO-200-MS-xx-PRK	.[Function]	.[Finish]	.[Cylinder]	\$1,489.00						
CO-250, Magnetic stripe (Swipe) reader module - (Track 1, 2, or 3)	EXT-CO-250-MS-xx-MS	.[Function]	.[Finish]	.[Cylinder]	\$1,254.00						
CO-250, Magnetic stripe (Swipe) with keypad reader module - (Track 1, 2, or 3)	EXT-CO-250-MS-xx-MSK	.[Function]	.[Finish]	.[Cylinder]	\$1,373.00						
Mortise Deadbolt											
CO-200, Keypad only reader module	EXT-CO-200-MD-40-KP	.[Function]	.[Finish]	.[Cylinder]	\$1,074.00						
CO-200, Magnetic stripe (Swipe) reader module - (Track 1, 2, or 3)	EXT-CO-200-MD-40-MS	.[Function]	.[Finish]	.[Cylinder]	\$1,254.00						
CO-200, Magnetic stripe (Swipe) with keypad reader module - (Track 1, 2, or 3)	EXT-CO-200-MD-40-MSK	.[Function]	.[Finish]	.[Cylinder]	\$1,373.00						
CO-200, Proximity reader module - (125 kHz Proximity)	EXT-CO-200-MD-40-PR	.[Function]	.[Finish]	.[Cylinder]	\$1,373.00						
CO-200, Proximity with keypad reader module - (125 kHz Proximity)	EXT-CO-200-MD-40-PRK	.[Function]	.[Finish]	.[Cylinder]	\$1,489.00						
CO-250, Magnetic stripe (Swipe) reader module - (Track 1, 2, or 3)	EXT-CO-250-MD-40-MS	.[Function]	.[Finish]	.[Cylinder]	\$1,254.00						
CO-250, Magnetic stripe (Swipe) with keypad reader module - (Track 1, 2, or 3)	EXT-CO-250-MD-40-MSK	.[Function]	.[Finish]	.[Cylinder]	\$1,373.00						
Exit											
CO-100, Keypad only reader module	EXT-CO-100-993-xx-KP	.[Function]	.[Finish]	.[Cylinder]	\$687.00						
CO-200, Keypad only reader module	EXT-CO-200-993-xx-KP	.[Function]	.[Finish]	.[Cylinder]	\$1,013.00						
CO-200, Magnetic stripe (Swipe) reader module - (Track 1, 2, or 3)	EXT-CO-200-993-xx-MS	.[Function]	.[Finish]	.[Cylinder]	\$1,198.00						
CO-200, Magnetic stripe (Swipe) with keypad reader module - (Track 1, 2, or 3)	EXT-CO-200-993-xx-MSK	.[Function]	.[Finish]	.[Cylinder]	\$1,315.00						
CO-200, Proximity reader module - (125 kHz Proximity)	EXT-CO-200-993-xx-PR	.[Function]	.[Finish]	.[Cylinder]	\$1,315.00						
CO-200, Proximity with keypad reader module - (125 kHz Proximity)	EXT-CO-200-993-xx-PRK	.[Function]	.[Finish]	.[Cylinder]	\$1,438.00						
CO-250, Magnetic stripe (Swipe) reader module - (Track 1, 2, or 3)	EXT-CO-250-993-xx-MS	.[Function]	.[Finish]	.[Cylinder]	\$1,198.00						
CO-250, Magnetic stripe (Swipe) with keypad reader module - (Track 1, 2, or 3)	EXT-CO-250-993-xx-MSK	.[Function]	.[Finish]	.[Cylinder]	\$1,315.00						

PARTS AND ACCESSORIES

KEYPAD MEMBRANE		
Description	Specify	Price
Keypad membrane	44487247	\$57.00

MAGNETIC SWIPE CLEANING CARDS		
Description	Specify	Price
Magnetic stripe cleaning cards	510310	\$57.20

INTERIOR ESCUTCHEON (Select by Chassis Type, Function)		Available finishes									
		605	606	612	613	619	622	625	626	643e	626AM
Chassis type	Description	Specify		Price							
		Part number	Finish								
		▪	▪	▪	N/A	▪	N/A	▪	▪	▪	▪
Cylindrical	Interior escutcheon, non-privacy	23599327	[Finish]	\$194.70							
Cylindrical	Interior escutcheon, privacy	23599335	[Finish]	\$237.90							
Mortise	Interior escutcheon, non-privacy	23599327	[Finish]	\$194.70							
Mortise	Interior escutcheon, privacy	23599335	[Finish]	\$237.90							
Mortise Deadbolt	Interior escutcheon, non-privacy	23599343	[Finish]	\$219.20							
Mortise Deadbolt	Interior escutcheon, privacy	23599350	[Finish]	\$237.90							
Exit	Interior escutcheon, non-privacy (with (4) screws)	46929279	[Finish]	\$84.00							

INTERIOR BASEPLATE GASKET			
Chassis type	Description	Specify	Price
Exit	Interior baseplate gasket	46928982	\$50.00

USB COVER PLUG, 10-PIECE BULK PACK		
Description	Specify	Price
USB Cover Plug (10-Piece Bulk Pack)	46928719	\$37.00
USB Cover Plug, Exit (10-Piece Bulk Pack)	47258550	\$37.00
Cable, USB, AD/CO, Exit	47253409	\$36.90

PARTS AND ACCESSORIES

EXTERIOR ESCUTCHEON (Select by Chassis Type, Class, Reader Type)		Available finishes									
		605	606	612	613	619	622	625	626	643e	626AM
		▪	▪	▪	N/A	▪	N/A	▪	▪	▪	▪
Chassis type	Description	Specify				Part number		Finish	Price		
Cylindrical	Exterior escutcheon, CO-100, KP (with 6 screws)	47260707				.[Finish]		\$334.00			
	Exterior escutcheon, CO-200, KP (with 6 screws)	47260709				.[Finish]		\$296.00			
	Exterior escutcheon, CO-200/250, PR/PRK/MS/MSK (with 6 screws, O-ring)	47260705				.[Finish]		\$184.00			
Mortise	Exterior escutcheon, CO-100, KP (with 6 screws)	47260707				.[Finish]		\$334.00			
	Exterior escutcheon, CO-200, KP (with 6 screws)	47260709				.[Finish]		\$296.00			
	Exterior escutcheon, CO-200/250, PR/PRK/MS/MSK (with 6 screws, O-ring)	47260705				.[Finish]		\$184.00			
Exit	Exterior escutcheon, CO-100, KP (with 6 screws)	47260708				.[Finish]		\$184.00			
	Exterior escutcheon, CO-200, KP (with 6 screws)	47260710				.[Finish]		\$296.00			
	Exterior escutcheon, CO-200/250, PR/PRK/MS/MSK (with 6 screws, O-ring)	47260706				.[Finish]		\$184.00			

EXTERIOR GASKET KIT (Select by Chassis Type)			
Chassis type	Description	Specify	Price
Cylindrical	Exterior gasket kit (Includes exterior baseplate gasket, spindle cover seal, reader O-ring)	47260740	\$74.00
Mortise	Exterior gasket kit (Includes exterior baseplate gasket, spindle cover seal, reader O-ring)	47260740	\$74.00
Exit	Exterior gasket kit (Includes exterior baseplate gasket, spindle cover seal, reader O-ring)	47260741	\$74.00

INTERIOR BASEPLATE SUBASSEMBLY (SELECT BY CHASSIS TYPE)			
Chassis type	Description	Specify	Price
Exit	Interior baseplate subassembly	23599251	\$47.60

INTERIOR BASEPLATE SPACER FOR SVR			
Chassis type	Description	Specify	Price
Exit	Interior baseplate spacer for SVR (with baseplate mounting screws, surface mount screws)	46929238	\$69.10

INTERIOR MOUNTING PLATE			
Chassis type	Description	Specify	Price
Exit	Interior mounting plate (with screws)	23599244	\$59.50

INTERIOR SPRING CAGE			
Chassis type	Description	Specify	Price
Cylindrical	Interior spring cage (with screws)	47260717	\$71.00
Mortise	Interior spring cage (with screws)	47260717	\$71.00

EXIT DEVICE MOUNTING HARDWARE KIT		Available finishes										
		605	606	612	613	619	622	625	626	643e	626AM	
		▪	▪	▪	N/A	▪	N/A	▪	▪	▪	▪	
Chassis type	Description	Specify				Part number		Device type	Finish	Door thickness	Price	
Exit	Exit device mounting hardware kit (upper mounting bolts, lower mounting sex-bolts, reader mounting bolts, finish washers, screws)	47260744				.[993R, 993S or 993M]		.[Finish]		.[]		\$124.00

PARTS AND ACCESSORIES

EXTERIOR SPRING CAGE (WITH SCREWS) (Select by Chassis Type, Cylinder OEM, Cylinder Type, Cylinder Detail)			
Cylindrical			
Description	New part number	Original part number	Price
Schlage, KIL, P6/L	47258543	46928552	\$104.00
Schlage, FSIC, R/J		46928552	
Schlage, SFIC, G/B		46928560	
Falcon, KIL, L-FA7 (7-pin)		23845969	
Corbin Russwin, FSIC, J-CO6 (6-pin)		46928586	
Corbin Russwin, FSIC, J-CO7 (7-pin)		23990674	
Sargent, KIL, L-SAR (6-pin)		46928578	
Sargent, FSIC, J-SAR (6-pin)		46928586	
Medeco, FSIC, J-MED (6-pin)		24281735	
Yale, FSIC, J-YA6 (6-pin)	46928644		
Yale, FSIC, J-YA7 (7-pin)	24281768		
Mortise			
Schlage, KIL, P6/L	47258543	46928602	\$104.00
Schlage, FSIC, R/J		46928610	
Schlage, SFIC, G/B		46928560	
Falcon, KIL, L-FA7 (7-pin)		23845977	
Corbin Russwin, FSIC, J-CO6 (6-pin)		46928636	
Corbin Russwin, FSIC, J-CO7 (7-pin)		23988033	
Sargent, KIL, L-SAR (6-pin)		46928628	
Sargent, FSIC, J-SAR (6-pin)		46928636	
Medeco, FSIC, J-MED (6-pin)		24281735	
Yale, FSIC, J-YA6 (6-pin)	46928644		
Yale, FSIC, J-YA7 (7-pin)	24281768		
Exit			
Schlage, KIL, P6/L (Steel Levers)	47258545	46928651	\$252.00
Schlage, FSIC, R/J (Steel Levers)		46928553	
Schlage, SFIC, G/B (Steel Levers)		46928669	
Falcon, KIL, L-FA7 (7-pin) (Steel Levers) - (Except ATH, 8AT Lever Style)		23779838	
Corbin Russwin, FSIC, J-CO6 (6-pin) (Steel Levers)		46928693	
Corbin Russwin, FSIC, J-CO7 (7-pin) (Steel Levers) - (Except ATH, 8AT Lever Style)		23988017	
Sargent, KIL, L-SAR (6-pin) (Steel Levers)		46928677	
Sargent, FSIC, J-SAR (6-pin) (Steel Levers)		46928685	
Medeco, FSIC, J-MED (6-pin)		24289902	
Yale, FSIC, J-YA6 (6-pin) (Steel Levers)	46928701		
Yale, FSIC, J-YA7 (7-pin)	24289928		

EXTERIOR SPRING CAGE AND TAILPIECE KIT (FOR SCHLAGE), 10-PIECE BULK PACK (Select by Chassis, Cylinder OEM, Cylinder Type, Cylinder Detail)			
Cylindrical			
Description	New part number	Original part number	Price
Schlage, KIL, P6/L	47259238	23593270	\$1,026.00
Schlage, FSIC, R/J	47259239	23593288	\$1,027.00
Schlage, SFIC, G/B	47259240	23593304	\$1,026.00
Mortise			
Schlage, KIL, P6/L	47259238	23593346	\$1,026.00
Schlage, FSIC, R/J	47259239	23593353	\$1,027.00
Schlage, SFIC, G/B	47259240	23593304	\$1,026.00
Exit			
Schlage, KIL, P6/L	47259249	23593271	\$1,026.00
Schlage, FSIC, R/J	47259250	23593272	\$3,415.00
Schlage, SFIC, G/B	47259248	23593437	\$1,833.00
		23593510	

CREDENTIALS
 READERS
 READER CONTROLLERS
 MULTI-FAMILY
 ENGAGE
 AD SERIES
 CO SERIES
 ELECTROMAGNETIC LOCKS
 POWER SUPPLIES
 VON DUPRIN ACCESS CONTROL
 SYSTEM ACC
 MISC

PARTS AND ACCESSORIES

EXTERIOR SPRING CAGE AND TAILPIECE KIT (FOR NON-SCHLAGE), SINGLE PIECE (Select by Chassis Type, Cylinder OEM, Cylinder Type, Cylinder Detail)

Cylindrical			
Description	New part number	Original part number	Price
Falcon, KIL, L-FA7 (7-pin)	47259244	23845985	\$124.00
Corbin Russwin, FSIC, J-CO6 (6-pin)	47259242	23593320	\$538.00
Corbin Russwin, FSIC, J-CO7 (7-pin)		23990666	
Sargent, KIL, L-SAR (6-pin)	47259241	23593312	\$502.00
Sargent, FSIC, J-SAR (6-pin)	47259242	23593320	\$538.00
Medeco, FSIC, J-MED (6-pin)	47259245	24281792	\$566.00
Yale, FSIC, J-YA6 (6-pin)	47259243	23593395	\$566.00
Yale, FSIC, J-YA7 (7-pin)	47259246	24281826	\$497.00
Mortise			
Falcon, KIL, L-FA7 (7-pin)	47259244	23845923	\$124.00
Corbin Russwin, FSIC, J-CO6 (6-pin)	47259242	23593387	\$538.00
Corbin Russwin, FSIC, J-CO7 (7-pin)		23988041	
Sargent, KIL, L-SAR (6-pin)	47259241	23593379	\$502.00
Sargent, FSIC, J-SAR (6-pin)	47259242	23593387	\$538.00
Medeco, FSIC, J-MED (6-pin)	47259245	24281792	\$566.00
Yale, FSIC, J-YA6 (6-pin)	47259243	23593395	\$566.00
Yale, FSIC, J-YA7 (7-pin)	47259246	24281826	\$497.00
Exit			
Falcon, KIL, L-FA7 (7-pin)	47259254	23810872	\$130.00
Corbin Russwin, FSIC, J-CO6 (6-pin)	47259252	23593274	\$538.00
Corbin Russwin, FSIC, J-CO7 (7-pin) - (Except ATH, 8AT Lever Styles)		23988025	
Sargent, KIL, L-SAR (6-pin)	47259251	23593273	\$502.00
Sargent, FSIC, J-SAR (6-pin)	47259252	23593274	\$538.00
Medeco, FSIC, J-MED (6-pin)	47259255	24289936	\$547.00
Yale, FSIC, J-YA6 (6-pin)	47259253	23593275	\$547.00
Yale, FSIC, J-YA7 (7-pin)	47259257	24289944	\$467.00

TAILPIECE (FOR CYLINDER) (Select by Chassis Type, Cylinder OEM, Cylinder Type, Cylinder Detail)

Cylindrical			
Description	New part number	Original part number	Price
Schlage, KIL, P6/L - (Everest/Primus/Modular Cylinders) ¹	47258186	C604-243	\$3.10
Schlage, KIL, P6/L - (Classic Cylinders) ¹		C603-524	
Schlage, FSIC, J,R,T	23446339	23446339	\$7.30
Falcon, KIL, L-FA7 (7-pin)	47258182	23779820	\$35.90
Universal, SFIC, B/BDC	47258187	46929456	\$21.90
Corbin Russwin, FSIC, J-CO6 (6-pin)	47258180	23433634	\$55.10
Corbin Russwin, FSIC, J-CO7 (7-pin)		23854516	
Sargent, KIL, L-SAR (6-pin) - (Compatible with 10L and 11L)	47258179	23433626	\$8.40
Sargent, FSIC, J-SAR (6-pin)	47258180	23433634	\$55.10
Medeco, FSIC, J-MED (6-pin)	47258183	23810898	\$129.30
Yale, FSIC, J-YA6 (6-pin) - (Compatible with Medeco 31)	47258181	23760366	\$70.60
Yale, FSIC, J-YA7 (7-pin)	47258184	23929722	\$47.60
Universal, SFIC, G/H	23446347	23446347	\$17.50
Corbin Russwin, KIL L-CO6	47258185	-	\$21.70
Mortise			
Schlage, KIL, P6/L - (Everest/Primus/Modular Cylinders) ¹	47258186	23538077	\$3.10
Schlage, KIL, P6/L - (Classic Cylinders) ¹		23538085	
Schlage, FSIC, J,R,T	23446339	23446339	\$7.30
Falcon, KIL, L-FA7 (7-pin)	47258182	23779820	\$35.90
Universal, SFIC, B/BDC	47258187	46929456	\$21.90

1. This part is shared with Schlage mechanical and defaults to the Schlage mechanical discount.

PARTS AND ACCESSORIES

EXTERIOR SPRING CAGE AND TAILPIECE KIT (FOR NON-SCHLAGE), SINGLE PIECE (Select by Chassis Type, Cylinder OEM, Cylinder Type, Cylinder Detail)			
Mortise (continued)			
Description	New part number	Original part number	Price
Corbin Russwin, FSIC, J-CO6 (6-pin)	47258180	23443435	\$55.10
Corbin Russwin, FSIC, J-CO7 (7-pin)		23854516	
Sargent, KIL, L-SAR (6-pin) - (Compatible with 10L and 11L)	47258179	23443427	\$8.40
Sargent, FSIC, J-SAR (6-pin)	47258180	23443435	\$55.10
Medeco, FSIC, J-MED (6-pin)	47258183	23810898	\$129.30
Yale, FSIC, J-YA6 (6-pin) - (Compatible with Medeco 31)	47258181	23760366	\$70.60
Yale, FSIC, J-YA7 (7-pin)	47258184	23929722	\$47.60
Universal, SFIC, G/H	23446347	23446347	\$17.50
Corbin Russwin, KIL L-CO6	47258185	-	\$21.70
Exit			
Schlage, KIL, P6/L - (Everest/Primus/Modular Cylinders) ¹	47258186	23538077	\$3.10
Schlage, KIL, P6/L - (Classic Cylinders) ¹		23538085	
Schlage, FSIC, J,R,T	23446339	23446339	\$7.30
Falcon, KIL, L-FA7 (7-pin)	47258182	23779820	\$35.90
Universal, SFIC, B/BDC	47258187	46929456	\$21.90
Universal, SFIC, G/H	23446347	N523-091	\$17.50
Corbin Russwin, FSIC, J-CO6 (6-pin)	47258180	23443435	\$55.10
Corbin Russwin, FSIC, J-CO7 (7-pin)		23854516	
Sargent, KIL, L-SAR (6-pin)	47258179	23443427	\$8.40
Sargent, FSIC, J-SAR (6-pin)	47258180	23443435	\$55.10
Medeco, FSIC, J-MED (6-pin)	47258183	23810898	\$129.30
Yale, FSIC, J-YA6 (6-pin) - (Compatible with Medeco 31)	47258181	23760366	\$70.60
Yale, FSIC, J-YA7 (7-pin)	47258184	23929722	\$47.60
Universal, SFIC, G/H	23446347	23446347	\$17.50
AD/CO,, SFIC, B/BDC	47258187	09-774	\$21.90
Corbin Russwin, KIL L-CO6	47258185	-	\$21.70

1. This part is shared with Schlage mechanical and defaults to the Schlage mechanical discount.

TAILPIECE KIT (FOR EXTERIOR ESCUTCHEON INTO EXIT DEVICE)			
Exit trim			
Description	New part number	Original part number	Price
Tailpiece kit (includes tailpiece, tailpiece guide, pine tree clip)	-	46929303	\$29.50

TAILPIECE KIT, 10-PIECE BULK PACK (Select by Chassis Type, Cylinder OEM, Cylinder Type, Cylinder Detail)			
Cylindrical			
Description	New part number	Original part number	Price
Schlage, KIL, P6/L - (Classic Cylinders)	09-418	09-418	\$20.00
Schlage, KIL, P6/L - (Everest/Primus/Modular Cylinders)	09-417	09-417	\$20.00
Falcon, KIL, P6/L	23790611	23790611	\$34.00
Mortise			
Schlage, KIL, P6/L - (Classic Cylinders)	09-418	46928768	\$20.00
Schlage, KIL, P6/L - (Everest/Primus/Modular Cylinders)	09-417	46928776	\$20.00
Falcon, KIL, P6/L	23790611	-	\$34.00
Exit			
Schlage, KIL, P6/L - (Classic Cylinders)	09-418	46928768	\$20.00
Schlage, KIL, P6/L - (Everest/Primus/Modular Cylinders)	09-417	46928776	\$20.00
Falcon, KIL, P6/L	23790611	-	\$34.00

PARTS AND ACCESSORIES

CYLINDER (Select by Chassis Type, Cylinder Mechanism, Cylinder Type, Cylinder Detail)		
Cylindrical		
Description	Specify	Price
Classic, KIL, P6 - (Only ATH, 8AT Lever Styles) ¹	23-013	\$92.00
Classic, FSIC, R (Open)	23-030	\$105.00
Classic, FSIC, R (Restricted)	23-030	\$134.00
Primus, KIL, P6 - (Only ATH, 8AT Lever Styles)	20-750	\$199.00
Primus, FSIC, R	20-740	\$212.00
Primus UL, KIL, P6 - (Only ATH, 8AT Lever Styles)	20-550	\$266.00
Primus XP, KIL, P6 - (Only ATH, 8AT Lever Styles)	20-750-XP	\$199.00
Primus XP, FSIC, R	20-740-XP	\$212.00
Primus UL XP, KIL, P6 - (Only ATH, 8AT Lever Styles)	20-550-XP	\$266.00
Mortise		
Description	Specify	Price
Classic, KIL, P6 - (Except ATH, 8AT Lever Styles) (Open) ¹	23-118	\$92.00
Classic, KIL, P6 - (Except ATH, 8AT Lever Styles) (Restricted)	23-118	\$121.00
Classic, FSIC, R (Open)	23-030	\$105.00
Primus, KIL, P6 - (Except ATH, 8AT Lever Styles)	20-854	\$199.00
Primus, FSIC, R	20-740	\$212.00
Primus UL, KIL, P6 - (Except ATH, 8AT Lever Styles)	20-554	\$266.00
Primus XP, KIL, P6 - (Except ATH, 8AT Lever Styles)	20-854-XP	\$199.00
Primus XP, FSIC, R	20-740-XP	\$212.00
Primus UL XP, KIL, P6 - (Except ATH, 8AT Lever Styles)	20-554-XP	\$266.00
Exit		
Description	Specify	Price
Classic, KIL, P6 - (Except ATH, 8AT Lever Styles) (Open) ¹	23-118	\$92.00
Classic, KIL, P6 - (Except ATH, 8AT Lever Styles) (Restricted)	23-118	\$121.00
Classic, KIL, P6 - (Only ATH, 8AT Lever Styles) ¹	23-013	\$92.00
Classic, FSIC, R (Open)	23-030	\$105.00
Classic, FSIC, R (Restricted)	23-030	\$134.00
Primus, KIL, P6 - (Except ATH, 8AT Lever Styles)	20-854	\$199.00
Primus, KIL, P6 - (Only ATH, 8AT Lever Styles)	20-750	\$199.00
Primus, FSIC, R	20-740	\$212.00
Primus UL, KIL, P6 - (Except ATH, 8AT Lever Styles)	20-554	\$266.00
Primus UL, KIL, P6 - (Only ATH, 8AT Lever Styles)	20-550	\$266.00
Primus XP, KIL, P6 - (Except ATH, 8AT Lever Styles)	20-854-XP	\$199.00
Primus XP, KIL, P6 - (Only ATH, 8AT Lever Styles)	20-750-XP	\$199.00
Primus XP, FSIC, R	20-740-XP	\$212.00
Primus UL XP, KIL, P6 - (Except ATH, 8AT Lever Styles)	20-554-XP	\$266.00
Primus UL XP, KIL, P6 - (Only ATH, 8AT Lever Styles)	20-550-XP	\$266.00

This part is shared with Schlage mechanical and defaults to the Schlage mechanical discount.

PARTS AND ACCESSORIES

LATCHES				
13-247	14-049	14-051	14-050	

Available finishes	605	606	612	613	619	622	625	626	643e	626AM
	▪	▪	▪	N/A	▪	N/A	▪	▪	▪	N/A

DEADLATCHES				
Description	Backset	Specify		Price each
		Part number	Finish	
Square corner, 1-1/8" x 2-1/4"	2-3/4"	13-247	.[Finish]	\$125.00
Anti-friction fire door latch, Square corner, 1-1/8" x 2-1/4", 3/4" throw	2-3/4"	14-049	.[Finish]	\$525.00
Square corner, 1-1/8" x 2-1/4"	2-3/8"	14-051	.[Finish]	\$171.00
Square corner, 1-1/8" x 2-1/4"	3-3/4"	14-050	.[Finish]	\$156.00

INTERIOR LEVER (CLOSED)				Available finishes										
Description	Style options	New part number	Original part number	605	606	612	613	619	622	625	626	643e	626AM	
				▪	▪	▪	N/A	▪	N/A	▪	▪	▪	▪	▪
				Specify		Price								
Lever design	Finish													
Inside Lever, Closed	ATH (Athens) RHO (Rhodes) SPA (Sparta) TLR (Tubular)	03-230	03-030	.[Lever]	.[Finish]									

EXTERIOR LEVER (LESS CYLINDER)				Available finishes									
(Select by Chassis Type, Cylinder OEM, Cylinder Type, Cylinder Detail)				605	606	612	613	619	622	625	626	643e	626AM
				▪	▪	▪	N/A	▪	N/A	▪	▪	▪	▪
Cylindrical				Description	New part number	Original part number	Specify		Price				
							Lever design	Finish					
				Schlage, KIL, P6/L	03-231	03-031	.[Lever]	.[Finish]	\$196.00				
				Schlage, FSIC, R/J	03-232	03-032	.[Lever]	.[Finish]	\$196.00				
				Schlage, SFIC, G/B	03-200	03-000	.[Lever]	.[Finish]	\$263.00				
				Falcon, KIL, L-FA7 (7-pin) Standard	03-280	23779739	.RHO	.[Finish]	\$214.00				
						23779762	.SPA	.[Finish]	\$214.00				
				Falcon, KIL, L-FA7 (7-pin) Knurled		23779747	.8RO	.[Finish]	\$283.00				
						23779770	.8SP	.[Finish]	\$283.00				
				Corbin Russwin, FSIC, J-CO6 (6-pin)	03-266	03-066	.[Lever]	.[Finish]	\$361.00				
				Corbin Russwin, FSIC, J-CO7 (7-pin) Standard	03-235	23854524	.RHO	.[Finish]	\$361.00				
						23854540	.SPA	.[Finish]	\$361.00				
						23854565	.TLR	.[Finish]	\$361.00				
				Corbin Russwin, FSIC, J-CO7 (7-pin) Knurled		23854532	.8RO	.[Finish]	\$428.00				
						23854557	.8SP	.[Finish]	\$428.00				
						23854573	.8TR	.[Finish]	\$428.00				
				Sargent, KIL, L-SAR (6-pin)	03-244	03-044	.[Lever]	.[Finish]	\$361.00				
				Sargent, FSIC, J-SAR (6-pin)	03-277	03-077	.[Lever]	.[Finish]	\$361.00				
				Medeco, FSIC, J-MED (6-pin)	03-237	09-388	.[Lever]	.[Finish]	\$361.00				
				Yale, FSIC, J-YA6 (6-pin)	03-255	09-355	.[Lever]	.[Finish]	\$361.00				
				Yale, FSIC, J-YA7 (7-pin)	03-236	09-399	.[Lever]	.[Finish]	\$361.00				
				Corbin Russwin, KIL, L-CO6 (6-pin)	03-234	-	.[Lever]	.[Finish]	\$361.00				

PARTS AND ACCESSORIES

EXTERIOR LEVER (LESS CYLINDER) (Select by Chassis Type, Cylinder OEM, Cylinder Type, Cylinder Detail)			Available finishes									
			605	606	612	613	619	622	625	626	643e	626AM
			▪	▪	▪	N/A	▪	N/A	▪	▪	▪	▪
New lever options (Cylindrical)												
Description	New part number	Original part number	Specify		Price							
			Lever design	Finish								
Boardwalk - Closed	47258044	-	.BRK	.[Finish]	\$199.00							
Boardwalk - J	47258052	-	.BRK	.[Finish]	\$199.00							
Boardwalk - P6/L	47258048	-	.BRK	.[Finish]	\$199.00							
Boardwalk - BDC/B/G/H	47258040	-	.BRK	.[Finish]	\$199.00							
Broadway - Closed	47258043	-	.BRW	.[Finish]	\$199.00							
Broadway - J	47258051	-	.BRW	.[Finish]	\$199.00							
Broadway - P6/L	47258047	-	.BRW	.[Finish]	\$199.00							
Broadway - BDC/B/G/H	47258039	-	.BRW	.[Finish]	\$199.00							
Latitude - Closed	47258045	-	.LAT	.[Finish]	\$199.00							
Latitude - J	47258053	-	.LAT	.[Finish]	\$199.00							
Latitude - P6/L	47258049	-	.LAT	.[Finish]	\$199.00							
Latitude - BDC/B/G/H	47258041	-	.LAT	.[Finish]	\$199.00							
Longitude - Closed	47258046	-	.LON	.[Finish]	\$199.00							
Longitude - J	47258054	-	.LON	.[Finish]	\$199.00							
Longitude - P6/L	47258050	-	.LON	.[Finish]	\$199.00							
Longitude - BDC/B/G/H	47258042	-	.LON	.[Finish]	\$199.00							
Boardwalk (Tactile) - Closed	47260554	-	.8BK	.[Finish]	\$267.00							
Boardwalk (Tactile) - J	47260546	-	.8BK	.[Finish]	\$267.00							
Boardwalk (Tactile) - P6/L	47260550	-	.8BK	.[Finish]	\$267.00							
Boardwalk (Tactile) - BDC/B/G/H	47260538	-	.8BK	.[Finish]	\$267.00							
Broadway (Tactile) - Closed	47260553	-	.8BY	.[Finish]	\$267.00							
Broadway (Tactile) - J	47260545	-	.8BY	.[Finish]	\$267.00							
Broadway (Tactile) - P6/L	47260549	-	.8BY	.[Finish]	\$267.00							
Broadway (Tactile) - BDC/B/G/H	47260537	-	.8BY	.[Finish]	\$267.00							
Latitude (Tactile) - Closed	47260555	-	.8LT	.[Finish]	\$267.00							
Latitude (Tactile) - J	47260547	-	.8LT	.[Finish]	\$267.00							
Latitude (Tactile) - P6/L	47260551	-	.8LT	.[Finish]	\$267.00							
Latitude (Tactile) - BDC/B/G/H	47260539	-	.8LT	.[Finish]	\$267.00							
Longitude (Tactile) - Closed	47260556	-	.8LN	.[Finish]	\$267.00							
Longitude (Tactile) - J	47260548	-	.8LN	.[Finish]	\$267.00							
Longitude (Tactile) - P6/L	47260552	-	.8LN	.[Finish]	\$267.00							
Longitude (Tactile) - BDC/B/G/H	47260540	-	.8LN	.[Finish]	\$267.00							
Mortise												
Schlage, KIL, P6/L	03-231	09-331	.[Lever]	.[Finish]	\$196.00							
Schlage, FSIC, R/J	03-232	09-332	.[Lever]	.[Finish]	\$196.00							
Schlage, SFIC, G/B	03-200	03-000	.[Lever]	.[Finish]	\$263.00							
Falcon, KIL, L-FA7 (7-pin)	03-280	09-331	.[Lever]	.[Finish]	\$214.00							
Corbin Russwin, FSIC, J-CO6 (6-pin)	03-266	09-366	.[Lever]	.[Finish]	\$361.00							
Corbin Russwin, FSIC, J-CO7 (7-pin)	03-235	09-366	.[Lever]	.[Finish]	\$361.00							
Sargent, KIL, L-SAR (6-pin)	03-244	09-344	.[Lever]	.[Finish]	\$361.00							
Sargent, FSIC, J-SAR (6-pin)	03-277	09-377	.[Lever]	.[Finish]	\$361.00							
Medeco, FSIC, J-MED (6-pin)	03-237	09-388	.[Lever]	.[Finish]	\$361.00							
Yale, FSIC, J-YA6 (6-pin)	03-255	09-355	.[Lever]	.[Finish]	\$361.00							
Yale, FSIC, J-YA7 (7-pin)	03-236	09-399	.[Lever]	.[Finish]	\$361.00							
Corbin Russwin, KIL, L-CO6 (6-pin)	03-234	-	.[Lever]	.[Finish]	\$361.00							
New lever options (Mortise)												
Boardwalk - Closed	47258044	-	.BRK	.[Finish]	\$199.00							
Boardwalk - J	47258052	-	.BRK	.[Finish]	\$199.00							
Boardwalk - P6/L	47258048	-	.BRK	.[Finish]	\$199.00							
Boardwalk - BDC/B/G/H	47258040	-	.BRK	.[Finish]	\$199.00							

PARTS AND ACCESSORIES

EXTERIOR LEVER (LESS CYLINDER) (Select by Chassis Type, Cylinder OEM, Cylinder Type, Cylinder Detail)			Available finishes									
			605	606	612	613	619	622	625	626	643e	626AM
			▪	▪	▪	N/A	▪	N/A	▪	▪	▪	▪
New lever options (Mortise) (continued)												
Description	New part number	Original part number	Specify		Price							
			Lever design	Finish								
Broadway - Closed	47258043	-	.BRW	.[Finish]	\$199.00							
Broadway - J	47258051	-	.BRW	.[Finish]	\$199.00							
Broadway - P6/L	47258047	-	.BRW	.[Finish]	\$199.00							
Broadway - BDC/B/G/H	47258039	-	.BRW	.[Finish]	\$199.00							
Latitude - Closed	47258045	-	.LAT	.[Finish]	\$199.00							
Latitude - J	47258053	-	.LAT	.[Finish]	\$199.00							
Latitude - P6/L	47258049	-	.LAT	.[Finish]	\$199.00							
Latitude - BDC/B/G/H	47258041	-	.LAT	.[Finish]	\$199.00							
Longitude - Closed	47258046	-	.LON	.[Finish]	\$199.00							
Longitude - J	47258054	-	.LON	.[Finish]	\$199.00							
Longitude - P6/L	47258050	-	.LON	.[Finish]	\$199.00							
Longitude - BDC/B/G/H	47258042	-	.LON	.[Finish]	\$199.00							
Boardwalk (Tactile) - Closed	47260554	-	.8BK	.[Finish]	\$267.00							
Boardwalk (Tactile) - J	47260546	-	.8BK	.[Finish]	\$267.00							
Boardwalk (Tactile) - P6/L	47260550	-	.8BK	.[Finish]	\$267.00							
Boardwalk (Tactile) - BDC/B/G/H	47260538	-	.8BK	.[Finish]	\$267.00							
Broadway (Tactile) - Closed	47260553	-	.8BY	.[Finish]	\$267.00							
Broadway (Tactile) - J	47260545	-	.8BY	.[Finish]	\$267.00							
Broadway (Tactile) - P6/L	47260549	-	.8BY	.[Finish]	\$267.00							
Broadway (Tactile) - BDC/B/G/H	47260537	-	.8BY	.[Finish]	\$267.00							
Latitude (Tactile) - Closed	47260555	-	.8LT	.[Finish]	\$267.00							
Latitude (Tactile) - J	47260547	-	.8LT	.[Finish]	\$267.00							
Latitude (Tactile) - P6/L	47260551	-	.8LT	.[Finish]	\$267.00							
Latitude (Tactile) - BDC/B/G/H	47260539	-	.8LT	.[Finish]	\$267.00							
Longitude (Tactile) - Closed	47260556	-	.8LN	.[Finish]	\$267.00							
Longitude (Tactile) - J	47260548	-	.8LN	.[Finish]	\$267.00							
Longitude (Tactile) - P6/L	47260552	-	.8LN	.[Finish]	\$267.00							
Longitude (Tactile) - BDC/B/G/H	47260540	-	.8LN	.[Finish]	\$267.00							
Exit												
Schlage, KIL, P6/L	03-231	03-331	.[Lever]	.[Finish]	\$196.00							
Schlage, FSIC, R/J	03-232	03-332	.[Lever]	.[Finish]	\$196.00							
Schlage, SFIC, G/B	03-200	03-300	.[Lever]	.[Finish]	\$263.00							
Falcon, KIL, L-FA7 (7-pin)	03-280	03-331	.[Lever]	.[Finish]	\$214.00							
Corbin Russwin, FSIC, J-CO6 (6-pin)	03-266	03-366	.[Lever]	.[Finish]	\$361.00							
Corbin Russwin, FSIC, J-CO7 (7-pin)	03-235	03-366	.[Lever]	.[Finish]	\$361.00							
Sargent, KIL, L-SAR (6-pin)	03-244	03-344	.[Lever]	.[Finish]	\$361.00							
Sargent, FSIC, J-SAR (6-pin)	03-277	03-377	.[Lever]	.[Finish]	\$361.00							
Medeco, FSIC, J-MED (6-pin)	03-237	03-388	.[Lever]	.[Finish]	\$361.00							
Yale, FSIC, J-YA6 (6-pin)	03-255	03-355	.[Lever]	.[Finish]	\$361.00							
Yale, FSIC, J-YA7 (7-pin)	03-236	03-399	.[Lever]	.[Finish]	\$361.00							
Corbin Russwin, KIL, L-CO6 (6-pin)	03-234	-	.[Lever]	.[Finish]	\$361.00							
New lever options (Exit)												
Boardwalk - Closed	47258044	-	.BRK	.[Finish]	\$199.00							
Boardwalk - J	47258052	-	.BRK	.[Finish]	\$199.00							
Boardwalk - P6/L	47258048	-	.BRK	.[Finish]	\$199.00							
Boardwalk - BDC/B/G/H	47258040	-	.BRK	.[Finish]	\$199.00							
Broadway - Closed	47258043	-	.BRW	.[Finish]	\$199.00							
Broadway - J	47258051	-	.BRW	.[Finish]	\$199.00							
Broadway - P6/L	47258047	-	.BRW	.[Finish]	\$199.00							
Broadway - BDC/B/G/H	47258039	-	.BRW	.[Finish]	\$199.00							

CREDENTIALS
READERS
READER CONTROLLERS
MULTI-FAMILY
ENGAGE
AD SERIES
CO SERIES
ELECTROMAGNETIC LOCKS
POWER SUPPLIES
VON DUPRIN ACCESS CONTROL
SYSTEM ACC
MISC

PARTS AND ACCESSORIES

EXTERIOR LEVER (LESS CYLINDER) (Select by Chassis Type, Cylinder OEM, Cylinder Type, Cylinder Detail)			Available finishes									
			605	606	612	613	619	622	625	626	643e	626AM
			▪	▪	▪	N/A	▪	N/A	▪	▪	▪	▪
New lever options (Exit) (continued)												
Description	New part number	Original part number	Specify		Price							
			Lever design	Finish								
Latitude - Closed	47258045	-	.LAT	.[Finish]	\$199.00							
Latitude - J	47258053	-	.LAT	.[Finish]	\$199.00							
Latitude - P6/L	47258049	-	.LAT	.[Finish]	\$199.00							
Latitude - BDC/B/G/H	47258041	-	.LAT	.[Finish]	\$199.00							
Longitude - Closed	47258046	-	.LON	.[Finish]	\$199.00							
Longitude - J	47258054	-	.LON	.[Finish]	\$199.00							
Longitude - P6/L	47258050	-	.LON	.[Finish]	\$199.00							
Longitude - BDC/B/G/H	47258042	-	.LON	.[Finish]	\$199.00							
Boardwalk (Tactile) - Closed	47260554	-	.8BK	.[Finish]	\$267.00							
Boardwalk (Tactile) - J	47260546	-	.8BK	.[Finish]	\$267.00							
Boardwalk (Tactile) - P6/L	47260550	-	.8BK	.[Finish]	\$267.00							
Boardwalk (Tactile) - BDC/B/G/H	47260538	-	.8BK	.[Finish]	\$267.00							
Broadway (Tactile) - Closed	47260553	-	.8BY	.[Finish]	\$267.00							
Broadway (Tactile) - J	47260545	-	.8BY	.[Finish]	\$267.00							
Broadway (Tactile) - P6/L	47260549	-	.8BY	.[Finish]	\$267.00							
Broadway (Tactile) - BDC/B/G/H	47260537	-	.8BY	.[Finish]	\$267.00							
Latitude (Tactile) - Closed	47260555	-	.8LT	.[Finish]	\$267.00							
Latitude (Tactile) - J	47260547	-	.8LT	.[Finish]	\$267.00							
Latitude (Tactile) - P6/L	47260551	-	.8LT	.[Finish]	\$267.00							
Latitude (Tactile) - BDC/B/G/H	47260539	-	.8LT	.[Finish]	\$267.00							
Longitude (Tactile) - Closed	47260556	-	.8LN	.[Finish]	\$267.00							
Longitude (Tactile) - J	47260548	-	.8LN	.[Finish]	\$267.00							
Longitude (Tactile) - P6/L	47260552	-	.8LN	.[Finish]	\$267.00							
Longitude (Tactile) - BDC/B/G/H	47260540	-	.8LN	.[Finish]	\$267.00							

EXTERIOR LEVER (LESS CYLINDER), 10-PIECE BULK PACK (Select by Chassis Type, Cylinder OEM, Cylinder Type, Cylinder Detail)			Available finishes									
			605	606	612	613	619	622	625	626	643e	626AM
			▪	▪	▪	N/A	▪	N/A	▪	▪	▪	▪
Cylindrical												
Description	New part number	Original part number	Specify		Price							
			Lever design	Finish								
Schlage, KIL, P6/L ¹	K103-681	K103-031	.[Lever]	.[Finish]	\$1,553.00							
Schlage, FSIC, R/J ¹	K103-682	K103-032	.[Lever]	.[Finish]	\$1,849.00							
Schlage, SFIC, G/B ¹	K103-680	K103-000	.[Lever]	.[Finish]	\$1,849.00							
Falcon, KIL, L-FA7 (7-pin)	K103-689	-	.[Lever]	.[Finish]	\$2,965.00							
Sargent, KIL, L-SAR (6-pin) ¹	K103-683	K103-044	.[Lever]	.[Finish]	\$3,685.00							
Sargent, FSIC, J-SAR (6-pin) ¹	K103-685	K103-077	.[Lever]	.[Finish]	\$3,646.00							
Medeco, FSIC, J-MED (6-pin) ¹	K103-687	K109-388	.[Lever]	.[Finish]	\$3,689.00							
Yale, FSIC, J-YA6 (6-pin) ¹	K103-686	K103-055	.[Lever]	.[Finish]	\$3,689.00							
Yale, FSIC, J-YA7 (7-pin) ¹	K103-688	K109-399	.[Lever]	.[Finish]	\$3,689.00							
Corbin Russwin, FSIC, J-CO6 (6-pin) ¹	K103-684	K103-066	.[Lever]	.[Finish]	\$2,880.00							
Corbin Russwin, FSIC, J-CO7 (7-pin)	K103-690	23991086 (RHO)	.RHO	.[Finish]	\$2,965.00							
		23991094 (SPA)	.SPA	.[Finish]	\$2,965.00							
		23991102 (TLR)	.TLR	.[Finish]	\$2,860.00							
		23991110 (8RO)	.8RO	.[Finish]	\$3,653.00							
		23991128 (8SP)	.8SP	.[Finish]	\$3,653.00							
		23991136 (8TR)	.8TR	.[Finish]	\$3,653.00							

1. This part is shared with Schlage mechanical and defaults to the Schlage mechanical discount.

PARTS AND ACCESSORIES

EXTERIOR LEVER (LESS CYLINDER), 10-PIECE BULK PACK (Select by Chassis Type, Cylinder OEM, Cylinder Type, Cylinder Detail)			Available finishes									
			605	606	612	613	619	622	625	626	643e	626AM
			▪	▪	▪	N/A	▪	N/A	▪	▪	▪	▪
Mortise												
Description	New part number	Original part number	Specify		Price							
			Lever design	Finish								
Schlage, KIL, P6/L ¹	K103-681	K109-331	.[Lever]	.[Finish]	\$1,553.00							
Schlage, FSIC, R/J ¹	K103-682	K109-332	.[Lever]	.[Finish]	\$1,849.00							
Schlage, SFIC, G/B ¹	K103-680	K103-000	.[Lever]	.[Finish]	\$1,849.00							
Falcon, KIL, L-FA7 (7-pin)	K103-689	K109-331	.[Lever]	.[Finish]	\$2,965.00							
Sargent, KIL, L-SAR (6-pin) ¹	K103-683	K109-344	.[Lever]	.[Finish]	\$3,685.00							
Sargent, FSIC, J-SAR (6-pin) ¹	K103-685	K109-377	.[Lever]	.[Finish]	\$3,646.00							
Medeco, FSIC, J-MED (6-pin) ¹	K103-687	K109-388	.[Lever]	.[Finish]	\$3,689.00							
Yale, FSIC, J-YA6 (6-pin) ¹	K103-686	K109-355	.[Lever]	.[Finish]	\$3,689.00							
Yale, FSIC, J-YA7 (7-pin) ¹	K103-688	K109-399	.[Lever]	.[Finish]	\$3,689.00							
Corbin Russwin, FSIC, J-CO6 (6-pin) ¹	K103-684	K109-366	.[Lever]	.[Finish]	\$2,880.00							
Corbin Russwin, FSIC, J-CO7 (7-pin)	K103-690	K109-366	.[Lever]	.[Finish]	\$2,965.00							
Exit												
Schlage, KIL, P6/L ¹	K103-681	K103-331	.[Lever]	.[Finish]	\$1,553.00							
Schlage, FSIC, R/J ¹	K103-682	K103-332	.[Lever]	.[Finish]	\$1,849.00							
Schlage, SFIC, G/B ¹	K103-680	K103-000	.[Lever]	.[Finish]	\$1,849.00							
Falcon, KIL, L-FA7 (7-pin)	K103-689	K103-331	.[Lever]	.[Finish]	\$2,965.00							
Sargent, KIL, L-SAR (6-pin) ¹	K103-683	K103-344	.[Lever]	.[Finish]	\$3,685.00							
Sargent, FSIC, J-SAR (6-pin) ¹	K103-685	K103-377	.[Lever]	.[Finish]	\$3,646.00							
Medeco, FSIC, J-MED (6-pin)	K103-687	K103-388	.[Lever]	.[Finish]	\$3,689.00							
Yale, FSIC, J-YA6 (6-pin) ¹	K103-686	K103-355	.[Lever]	.[Finish]	\$3,689.00							
Yale, FSIC, J-YA7 (7-pin) ¹	K103-688	K103-399	.[Lever]	.[Finish]	\$3,689.00							
Corbin Russwin, FSIC, J-CO6 (6-pin)	K103-684	K103-366	.[Lever]	.[Finish]	\$2,880.00							
Corbin Russwin, FSIC, J-CO7 (7-pin)	K103-690	K103-366	.[Lever]	.[Finish]	\$2,965.00							

1. This part is shared with Schlage mechanical and defaults to the Schlage mechanical discount.

INTERIOR ROSE			Available finishes								
			605	606	612	613	619	622	625	626	643e
			▪	▪	▪	▪	N/A	▪	▪	▪	N/A
Description	Specify		Price								
	Part number	Finish									
Interior rose (626 finish)	03-042-RHO	-	\$149.00								
Interior rose (605/606/612/619/625/643e finishes)	03-042-RHO	-	\$149.00								
Interior rose (613 finish)	03-042-RHO	-	\$149.00								

DEADBOLT THUMB TURN ASSEMBLY (WITH E-CLIP)			Available finishes								
			605	606	612	613	619	622	625	626	643e
			▪	▪	▪	N/A	▪	N/A	▪	▪	▪
Description	Specify		Price								
	Part number	Finish									
Deadbolt thumb turn assembly (with E-clip)	46929113	.[Finish]	\$49.80								

LOCK RETRACTOR (Select by Chassis Type, Chassis Thickness)			
Chassis type	Description	Specify	Price
Cylindrical	Retractor	46928800	\$497.00
Mortise case	1-1/16" Narrow - (door thicknesses 1-3/8" to 1-5/8")	46928818	\$637.00
	1-1/4" Standard - (door thicknesses 1-3/4" to 2-3/4")	46928826	\$637.00
Mortise case with deadbolt	1-1/16" Narrow - (door thicknesses 1-3/8" to 1-5/8")	46928834	\$805.00
	1-1/4" Standard - (door thicknesses 1-3/4" to 2-3/4")	46928842	\$805.00

CREDENTIALS
 READERS
 READER CONTROLLERS
 MULTI-FAMILY
 ENGAGE
 AD SERIES
 CO SERIES
 ELECTROMAGNETIC LOCKS
 POWER SUPPLIES
 VON DUPRIN ACCESS CONTROL
 SYSTEM ACC
 MISC

PARTS AND ACCESSORIES

SPINDLE AND HUB KIT (Select by Chassis Type)			
Chassis type	Description	Specify	Price
Exit	Exit spindle and hub kit (Includes spindle, spindle cover, spindle hub, tailpiece, twisted tailpiece, tailpiece spring, pine tree clip, screw)	46929295	\$61.70

SPINDLE SPRING			
Description	Specify	Price	
Inside spindle spring (25 pack)	47256978	\$114.50	

HUB, 10-PIECE BULK PACK (Select by Chassis Type)			
Chassis type	Description	Specify	Price
Cylindrical	Hub (10-piece bulk pack)	23599228	\$225.80
Mortise	Hub (10-piece bulk pack)	23599228	\$225.80

STRIKE PLATE (Select by Chassis Type)							
10-025	10-013	10-016	K510-066	10-072	10-075	37-015	

Available finishes	605	606	612	613	619	622	625	626	643e	626AM
	▪	▪	▪	N/A	▪	N/A	▪	▪	▪	▪

Cylindrical					
Description	Default lip length	Specify			Price
		Part number	Finish	Lip length	
1-1/4" x 4-7/8" ANSI, no box ¹	1-3/16"	10-025-1316	.[Finish]	.LIP1-3/16	\$21.80
1-1/4" x 4-7/8" ANSI, no box ¹	1-3/8"	10-025-138	.[Finish]	.LIP1-3/8	\$62.60
1-1/4" x 4-7/8" ANSI, no box ¹	1-1/2"	10-025-112	.[Finish]	.LIP1-1/2	\$62.60
1-1/8" x 2-3/4" square corner, T-strike, box ¹	1-1/8"	10-013-118	.[Finish]	.LIP1-1/8	\$21.80
1-1/8" x 2-3/4" square corner, T-strike, box ¹	1-1/2"	10-013-112	.[Finish]	.LIP1-1/2	\$21.80
1-1/8" x 2-3/4" square corner, T-strike, deep box ^{1,2}	1-1/8"	10-016	.[Finish]	.LIP1-1/8	\$21.80
Box for ANSI strike (finish not applicable) ¹	-	K510-066	-	-	\$9.70
Mortise Deadbolt					
1-1/4" x 4-7/8" square corner, box (standard with Lip at 1-3/16", 1", 1-1/2", 1-3/4", or 2") ¹	1-3/16"	10-072-1316	.[Finish]	.LIP1-3/16	\$32.00
1-1/4" x 4-7/8" square corner, box (specify lip length [xx] as 1" or 1-1/2") ¹	1-3/16"	10-072-xx	.[Finish]	.[Lip length]	\$32.00
1-1/4" x 4-7/8" square corner, box (specify lip length [xx] as 1-3/4", 1" or 2") ¹	1-3/16"	10-072-xx	.[Finish]	.[Lip length]	\$82.00
1/2" Rabbeted ¹	-	10-075	.[Finish]	.[Lip length]	\$211.00
Strike frame reinforcer (finish not applicable)	-	37-015	-	-	\$35.90

1. This part is shared with Schlage mechanical and defaults to the Schlage mechanical discount.
 2. Use with fire door latch.

PARTS AND ACCESSORIES

MORTISE ARMOR FRONT (Select by Width, Door Thickness)				
09-663	09-666	09-669	09-672	
Available finishes				605 606 612 613 619 622 625 626 643e 626AM ▪ ▪ ▪ N/A ▪ N/A ▪ ▪ ▪ ▪
1-1/4" Wide (Standard armor size for 1-3/4" and larger door thicknesses)				
Description	Specify		Price	
	Part number	Finish		
Latch x auxiliary latch ¹	09-663	.[Finish]	\$53.00	
Latch x auxiliary latch x deadbolt ¹	09-666	.[Finish]	\$53.00	
1-1/16" Wide (armor size for doors thinner than 1-3/4", including 1-3/8" doors)				
Latch x auxiliary latch ¹	09-669	.[Finish]	\$53.00	
Latch x auxiliary latch x deadbolt ¹	09-672	.[Finish]	\$53.00	

1. This part is shared with Schlage mechanical and defaults to the Schlage mechanical discount.
2. Use with fire door latch.

DECORATIVE PLATE (Select by Size)		Available finishes												
		605 ³	606	612	613	619	622	625	626	643e ³	626AM			
		▪	▪	▪	N/A	▪	N/A	▪	▪	▪	▪	▪	▪	N/A
Size	Description	Specify		Price										
		Part number	Finish											
1.5" x 3.25" x .105"	Decorative plate (with screws) - (Exit trim)	23631823	.[Finish]	\$52.50										
1.7" x 3.5" x .075"	Decorative plate (with screws)	23760267	.[Finish]	\$38.50										
3.2" x 3.5" x .075"	Decorative plate (with screws)	23760283	.[Finish]	\$59.70										
6.0" x 3.5" x .075"	Decorative plate (with screws)	23760317	.[Finish]	\$90.80										
6.6" x 3.5" x .075"	Decorative plate (with screws)	23760325	.[Finish]	\$90.80										
8.0" x 3.5" x .075"	Decorative plate (with screws)	23760309	.[Finish]	\$92.90										
8.0" x 3.5" x .075"	Decorative plate (with screws and welded standoff)	23760291	.[Finish]	\$125.90										
10.5" x 3.5" x .075"	Decorative plate (no screws necessary) - (under lock) ⁴	23760259	.[Finish]	\$120.10										
12.0" x 3.5" x .075"	Decorative plate (no screws necessary) - (under lock) ⁴	23760275	.[Finish]	\$118.90										

3. 626 Satin Chrome finish standard. Please consult Customer Care for 605 Bright Brass or 643E Aged Bronze.
4. Please consider overall Door Thickness when ordering.
5. Single Decorative plate. Interior and Exterior Decorative plates may be required.
6. Decorative plates may have multiple applications. Please see AD Series Retrofit Template Overlay guide at www.schlage.com/support for more information.

PARTS AND ACCESSORIES

DOOR THICKNESS KIT (Select by Chassis Type, Door Thickness)			
Cylindrical			
Description	Specify		Price
	Part number	Door thickness	
1-3/8" Door thickness kit (Includes baseplate screws, reader screws, spindles, spring, pin wrench, fire plate screw, shim plates, standoffs)	23599376-138	. []	\$243.00
1-1/2" Door thickness kit (Includes baseplate screws, reader screws, spindles, spring, pin wrench, fire plate screw, shim plates, standoffs)	23599376-112	. []	\$173.00
1-5/8" Door thickness kit (Includes baseplate screws, reader screws, spindles, spring, pin wrench, fire plate screw, shim plates, standoffs)	23599376-158	. []	\$124.00
Door thickness kit (Includes baseplate screws, reader screws, spindles, spring, pin wrench, fire plate screw, shim plates, standoffs) ¹	23599376-xxx	. []	\$74.00
Mortise			
1-3/8" Door thickness kit (Includes baseplate screws, reader screws, spindles, spring, pin wrench, fire plate screw, shim plates, standoffs)	23599384-138	. []	\$243.00
1-1/2" Door thickness kit (Includes baseplate screws, reader screws, spindles, spring, pin wrench, fire plate screw, shim plates, standoffs)	23599384-112	. []	\$173.00
1-5/8" Door thickness kit (Includes baseplate screws, reader screws, spindles, spring, pin wrench, fire plate screw, shim plates, standoffs)	23599384-158	. []	\$124.00
Door thickness kit (Includes baseplate screws, reader screws, spindles, spring, pin wrench, fire plate screw, shim plates, standoffs) ¹	23599384-xxx	. []	\$74.00

1. Must specify door thickness: 1-3/4" to 2-3/4" in 1/8" increments.

BATTERY HOLDER AND COVER KIT (Select by Chassis Type, Battery Capacity)		Available finishes									
		605	606	612	613	619	622	625	626	643e	626AM
		▪	▪	▪	N/A	▪	N/A	▪	▪	▪	▪
Chassis type	Description	Specify		Price							
		Part number	Finish								
Cylindrical	4AA Battery holder and cover kit (Includes 4AA Battery holder with cable, 4AA battery strap, (2) battery strap screws, 4AA battery cover, cover screw, Torx® cover screw)	4B-CM (23599202)	. [Finish]	\$83.20							
Mortise	4AA Battery holder and cover kit (Includes 4AA Battery holder with cable, 4AA battery strap, (2) battery strap screws, 4AA battery cover, cover screw, Torx cover screw)	4B-CM (23599202)	. [Finish]	\$83.20							
Exit	4AA Battery holder and cover kit (Includes 4AA Battery holder with cable, 4AA battery strap, (2) battery strap screws, 4AA battery cover, cover screw, Torx cover screw)	4B-E (23599285)	. [Finish]	\$83.20							

INTERIOR SHIM PLATE		Available finishes									
		605	606	612	613	619	622	625	626	643e	626AM
		▪	▪	▪	N/A	▪	N/A	▪	▪	▪	▪
Description		Specify		Price							
		Part number	Finish								
Interior shim plate (with interior spring cage spacer) - (Device is 0.063" thick)		23599368	. [Finish]	\$35.80							

EXTERIOR SHIM PLATE		
Description	Specify	Price
Exterior shim plate - (Device is 0.063" thick)	23458599	\$33.40

PARTS AND ACCESSORIES

TORX® TAMPER SCREW PACK (Select by Chassis Type)			
Chassis type	Description	Specify	Price
Cylindrical	Torx tamper screw pack	23631765	\$59.70
Mortise	Torx tamper screw pack	23631781	\$59.70
Exit	Torx tamper screw pack	23631799	\$47.60

DOOR POSITION SWITCH		
Description	Specify	Price
Door Position Switch	46929121	\$46.90

BATTERY HOLDER KIT		
Description	Specify	Price
4AA Battery holder kit (Includes 4AA battery holder with cable, 4AA battery strap, battery strap screws)	46929063	\$35.90

BATTERY (Select by Battery Type)		
Description	Specify	Price
(4) AA Batteries	F206-488	\$16.00

REQUEST-TO-EXIT SWITCH KIT		
Description	Specify	Price
Von Duprin RX-LC (also called SI-LC or Von Duprin part number 050281)	RX-LC	\$482.00

Please see Falcon Price Book for Falcon AD part number 650359.

WIRELESS PARTS		
Description	Specify	Price
Terminal block kit – (Includes one power connector and ten I/O connectors) supports CT5000	47250326	\$65.90

CABLES		
Description	Specify	Price
Storeroom (70) Thru-door cable	23518392	\$27.50
Privacy (40) and Office (50) Thru-door cable	23518384	\$44.30
(Warm) Keypad, MSK, CO, KIT	47269270	\$55.80
(Warm) Keypad, core, keypad + proximity, CO, KIT	47269272	\$55.80
Inside push button, AD/CO	47269170	\$87.00
CO Battery cable (5 pack)	47267321	\$56.00



Contents

M490 Max security series 259
 M450 High security series.....260
 M420 Traffic control series261
 M490DE Delayed egress series 262
 M390RFK Retrofit lock 263
 Filler plates and angle brackets264
 Electromagnetic specialty locks 265
 M490G Gate lock 265
 320M MiniLine magnet lock 265
 GF3000 Shear lock mortise series266
 GF3000 Shear lock surface series 267
 Electromagnetic lock parts.....268

Customer service	Technical support
<ul style="list-style-type: none"> ▪ Order status ▪ Credit returns of non-defective products ▪ General sales questions <p>USA Allegion_Orders@allegion.com CAN Canada.CustomerService@allegion.com</p>	<ul style="list-style-type: none"> ▪ Technical questions/issues ▪ Returns of defective products ▪ Repairs <p>USA Electronic_Lock_TechProdSupport@allegion.com CAN Canada.TechServices@allegion.com</p>

CREDENTIALS

READERS

READER CONTROLLERS

MULTI-FAMILY

ENGAGE

AD SERIES

CO SERIES

ELECTROMAGNETIC LOCKS

POWER SUPPLIES

VON DUPRIN ACCESS CONTROL

SYSTEM ACC

MISC

M490 MAX SECURITY SERIES
with Limited Lifetime Warranty
on Magnetic Coil Assembly

Standard features

- ANSI/BHMA 156.23 Grade 1
- UL 1034 listed for burglary resistance
- UL 10C listed; cUL
- UL 294 listed for access control system units
- CSFM California State Fire Marshal listed

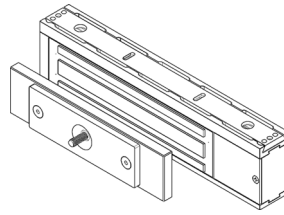

M490/M490P
Single lock

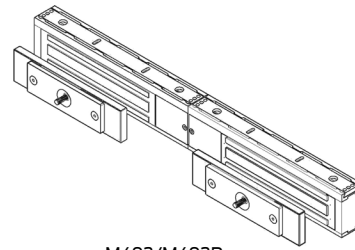

M492/M492P
Double lock - single housing

Patent # 5,133,581

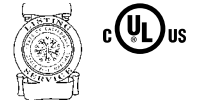

1. SELECT MODEL

	M490	M492
Electromagnetic lock	\$1,067.00	\$2,236.00
▪ Automatic voltage selection		
	M490P	M492P
Electromagnetic lock	\$1,381.00	\$2,864.00
▪ Automatic voltage selection		
▪ Magnetic Bond Sensor (MBS)		
▪ Door Position Switch (DPS)		
▪ Relocking Time Delay (RTD)		

2. SELECT OPTIONS AND ACCESSORIES

	M490/M490P		M492/M492P	
Anti-Tamper Switch (ATS), MBS indicator (LED)	450/490-ATS/LED	\$119.00	450/490-ATS/LED-2	\$240.00
▪ For M490P/M492P only				
Herculite door bracket	HDB490	\$536.00	HDB490-2	\$1,080.00
Top jamb (inswinging doors)	TJ490	\$259.00	TJ492	\$521.00
M452/M492 Connector kit	DBK450/490			\$100.00
▪ Used to convert two (2) single mag locks to a double				

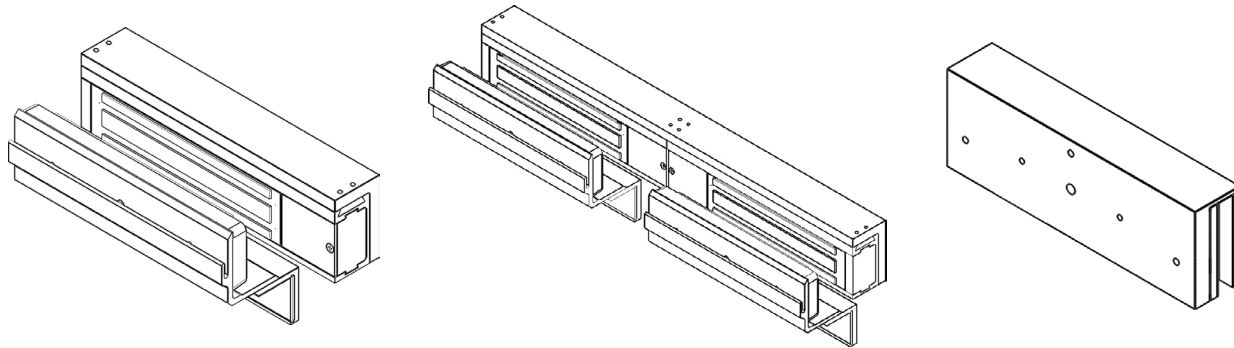

3. SELECT FILLER PLATES AND ANGLE BRACKETS - LISTED ON PAGE 264

Specifications	M490/M490P	M492/M492P
Holding force	1500 lbs	1500 lbs per door leaf
Input voltage	12/24 VDC	12/24 VDC
Current draw	.65A @ 12 VDC	1.3A @ 12 VDC
Automatic dual voltage 12/24 VDC	.35A @ 24 VDC	.7A @ 24 VDC
Height	3"	3"
Length	12-1/2"	25-1/16"
Width	1-3/4"	1-3/4"
Weight (approximate)	14 lbs	28 lbs



M450 HIGH SECURITY SERIES
with Limited Lifetime Warranty
on Magnetic Coil Assembly

Patent # 5,133,581

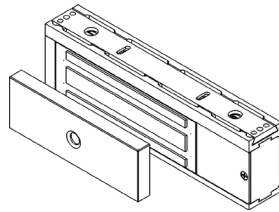
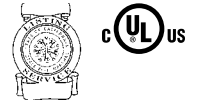

M450/M450P
Single lock

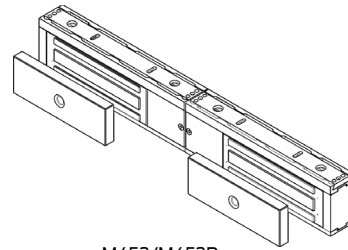

M452/M452P
Double lock with single housing

Standard features

- ANSI/BHMA 156.23 Grade 1
- UL 1034 listed for burglary resistance
- UL 10C listed; cUL
- UL 294 listed for access control system units
- CSFM California State Fire Marshal listed

1. SELECT MODEL

	M450	M452
Electromagnetic lock	\$976.00	\$2,045.00
▪ Automatic voltage selection		
	M450P	M452P
Electromagnetic lock	\$1,297.00	\$2,693.00
▪ Automatic voltage selection		
▪ Magnetic Bond Sensor (MBS)		
▪ Door Position Switch (DPS)		
▪ Relocking Time Delay (RTD)		

2. SELECT OPTIONS AND ACCESSORIES

	M450/M450P		M452/M452P	
Anti-Tamper Switch (ATS), MBS indicator (LED)	450/490-ATS/LED	\$119.00	450/490-ATS/LED-2	\$240.00
▪ For M450P/M452P only				
Herculite door bracket	HDB450	\$536.00	HDB450-2	\$1,080.00
Top jamb (inswinging doors)	TJ450	\$259.00	TJ452	\$521.00
M452/M492 Connector kit	DBK450/490			\$100.00
▪ Used to convert two (2) single mag locks to a double				

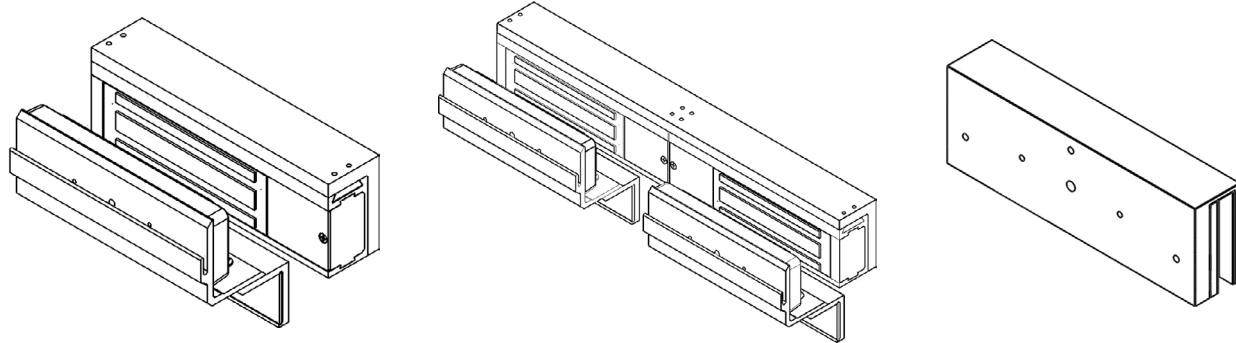

3. SELECT FILLER PLATES AND ANGLE BRACKETS - LISTED ON PAGE 264

Specifications	M450/M450P	M452/M452P
Holding force	1000 lbs	1000 lbs per door leaf
Input voltage	12/24 VDC	12/24 VDC
Current draw	.75A @ 12 VDC	1.5A @ 12 VDC
Automatic dual voltage 12/24 VDC	.38A @ 24 VDC	0.75A @ 24 VDC
Height	3"	3"
Length	10-1/4"	20-9/16"
Width	1-3/4"	1-3/4"
Weight (approximate)	10 lbs	20 lbs

CREDENTIALS
 READERS
 READER CONTROLLERS
 MULTI-FAMILY
 ENGAGE
 AD SERIES
 CO SERIES
 ELECTROMAGNETIC LOCKS
 POWER SUPPLIES
 VON DUPRIN ACCESS CONTROL
 SYSTEM ACC
 MISC

M420 TRAFFIC CONTROL SERIES
with Limited Lifetime Warranty
on Magnetic Coil Assembly

Standard features

- ANSI/BHMA 156.23 Grade 1
- UL 1034 listed for burglary resistance
- UL 10C listed; cUL
- UL 294 listed for access control system units
- CSFM California State Fire Marshal listed

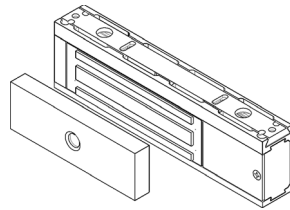

M420/M420P
Single lock

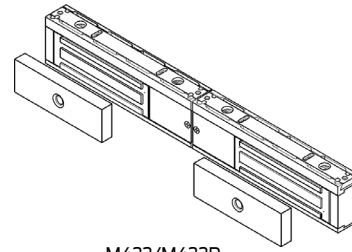

M422/M422P
Double lock with single housing

Patent # 5,133,581

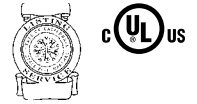

1. SELECT MODEL

	M420	M422
Electromagnetic lock	\$853.00	\$1,805.00
▪ Automatic voltage selection		
<hr/>		
	M420P	M422P
Electromagnetic lock	\$1,176.00	\$2,414.00
▪ Automatic voltage selection		
▪ Door Position Switch (DPS)		
▪ Magnetic Bond Sensor (MBS)		
▪ Relocking Time Delay (RTD)		

2. SELECT OPTIONS AND ACCESSORIES

	M420/M420P		M422/M422P	
Anti-Tamper Switch (ATS), MBS indicator (LED)	420-ATS/LED	\$119.00	420-ATS/LED-2	\$240.00
▪ For M420P/M422P only				
Herculite Door Bracket	HDB420	\$536.00	HDB420-2	\$1,146.00
Top Jamb (inswinging doors)	TJ420	\$259.00	TJ422	\$521.00
M422 Connector Kit	DBK420			\$100.00
▪ Used to convert two (2) single mag locks to a double				

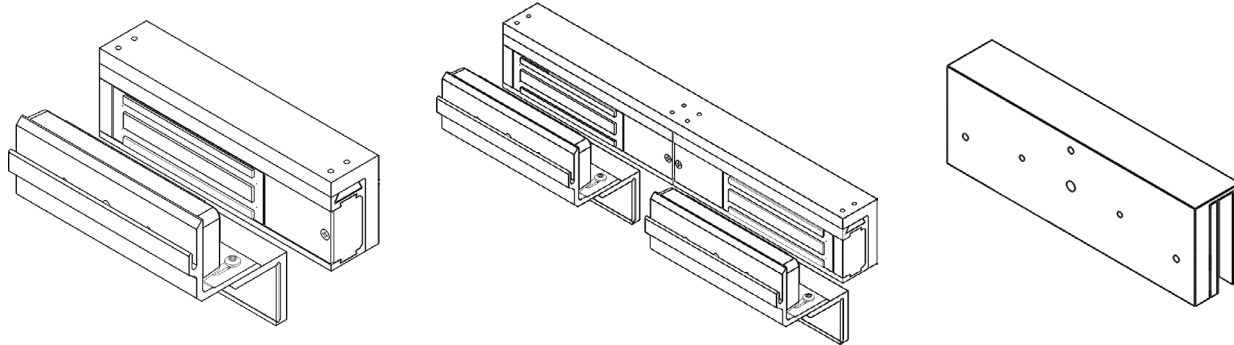

3. SELECT FILLER PLATES AND ANGLE BRACKETS - LISTED ON PAGE 264

Specifications	M420/M420P	M422/M422P
Holding force	500 lbs	500 lbs per door leaf
Input voltage	12/24 VDC	12/24 VDC
Current draw	.75A @ 12 VDC	1.5A @ 12 VDC
Automatic dual voltage 12/24 VDC	.38A @ 24 VDC	.76A @ 24 VDC
Height	2-1/2"	2-1/2"
Length	9"	18-1/16"
Width	1-3/8"	1-3/8"
Weight (approximate)	6 lbs	12 lbs

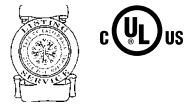

M490DE DELAYED EGRESS SERIES
with Limited Lifetime Warranty
on Magnetic Coil Assembly

Standard features

- Delayed egress with plunger switch & external switch input
- Designed to meet NFPA 101 Life Safety Code
- Automatic voltage selection
- UL294 Special locking arrangement including BOCA¹
- ANSI/BHMA 156.24
- UL 10C listed; cUL
- CSFM California State Fire Marshal listed
- Authorized release input
- On-board audible alarm
- On-board bi-color LED
- Fire alarm terminals

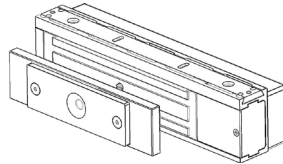

Single Lock

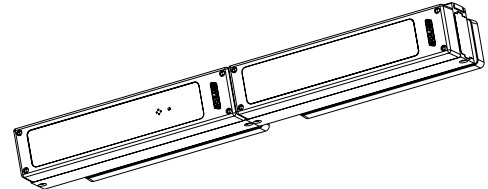

Double Lock - Separate Housing

¹ All 30 second delay requests require a letter from the local fire marshal or local jurisdiction for approval.

1. SELECT MODEL	Factory Set Delay		SINGLE LOCK		DOUBLE LOCK	
	15 sec	30 sec				
Electromagnetic delayed egress lock (DE)	▪		M490DE	\$2,295.00	M490DE-2	\$4,492.00
Delayed egress plus (DEP)	▪		M490DEP	\$3,444.00	M490DEP-2	\$6,660.00

1. Plus (P): Door Status Monitor (DSM), Magnetic Bond Sensor (MBS), Relocking Time Delay (RTD)

2. SELECT OPTIONS AND ACCESSORIES	Factory Set Delay		PART NO.	PRICE ADDER	PART NO.	PRICE ADDER
	15 sec	30 sec				
Delayed egress/Delayed egress plus (DEP)		▪	-30S	\$76.00	-30S	\$76.00
Delayed egress plus, BOCA (DEP-BC) ²	▪		BC	\$0.00	BC	\$0.00
Delayed egress plus, BOCA (DEP-BC) ²		▪	BC30S	\$76.00	BC30S	\$76.00
Herculite (glass) door bracket	-	-	HDB490	\$536.00	HDB490-2	\$1,080.00

- 2. For BOCA option please contact Customer Care. Only available on Plus (P) models.
- 3. PCB Kits (:15, :30 second) are sold separate for in-field updates. See [Parts Section](#) for M490DE, M490DEP and M490DEP BOCA kits.
- 4. All 30 second delay requests (product/ PCB kits), require a letter from the local fire marshal for approval or local jurisdiction.

3. SELECT FILLER PLATES AND ANGLE BRACKETS - LISTED ON PAGE 264

Specifications	M490DE/M490DEP	M490DE-2/M490DEP-2
Holding force	1300 lbs	1300 lbs per door leaf
Input voltage	12/24 VDC	12/24 VDC
Current draw automatic dual voltage 12/24 VDC	.75A @ 12 VDC .45A @ 24 VDC	1.25A @ 12 VDC 0.76A @ 24 VDC
Height	3"	3"
Length	12-1/2"	25-1/16"
Width	3-1/16"	3-1/16"
Weight (approximate)	16 lbs	32 lbs

M390RFK RETROFIT LOCK
with Limited Lifetime Warranty
on Magnetic Coil Assembly

Designed to retrofit Locknetics 390+ without any additional prep

Standard features

- ANSI/BHMA 156.23 Grade 1
- UL 294 listed for access control systems units
- UL 10C listed; cUL
- CSFM California State Fire Marshal listed

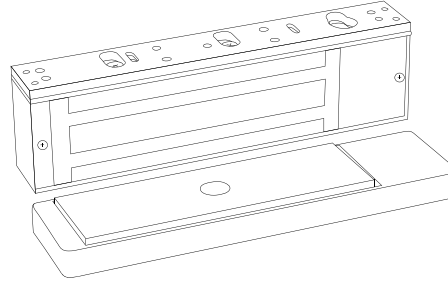

Single Lock

1. SELECT MODEL	M390RFK
Electromagnetic lock ▪ Automatic voltage selection ▪ Magnetic Bond Sensor (MBS) ▪ 628 Satin Aluminum finish ▪ Door Status Monitor (DSM)	\$1,342.00

2. SPECIFICATIONS	M390RFK
Holding force	1500 lbs
Input voltage	12/24 VDC
Current draw	.65A @ 12 VDC
Automatic dual voltage 12/24 VDC	.45A @ 24 VDC
Height	2-7/8"
Length	10-1/2"
Width	1-5/8"
Weight (approximate)	12.4 lbs

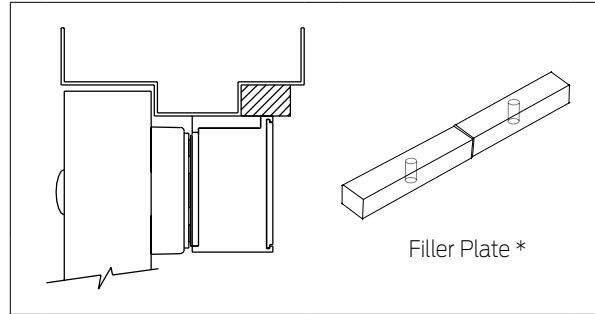
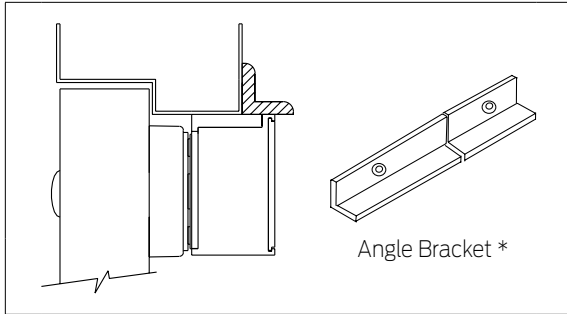
ANGLE BRACKETS
M420 (9")
M450 (10-1/4")

Width x Height	Bracket No.	Price Ea.	Bracket No.	Price Ea.
1" x 1"	4201A	\$128.00	4501A	\$128.00
1-1/2" x 1"	4202A	\$139.00	4502A	\$139.00
1-1/2" x 1-1/2"	4203A	\$146.00	4503A	\$146.00
1-1/2" x 2"	4204A	\$190.00	4504A	\$190.00
1-1/2" x 2-1/2"	4205A	\$230.00	4505A	\$230.00

Note: Overall lengths are cut to the appropriate magnet size.

ANGLE BRACKETS
M490/M490DE (12-1/2")
M490G Corrosion Resistant (11")

Width x Height	Bracket No.	Price Ea.	Bracket No.	Price Ea.
1" x 1"	4901A	\$128.00	49G1A	\$128.00
1-1/2" x 1"	4902A	\$139.00	49G2A	\$139.00
1-1/2" x 1-1/2"	4903A	\$146.00	49G3A	\$146.00
1-1/2" x 2"	4904A	\$190.00	49G4A	\$190.00
1-1/2" x 2-1/2"	4905A	\$230.00	49G5A	\$230.00

Note: Overall lengths are cut to the appropriate magnet size.

FILLER PLATES
M420 (9")
M450 (10-1/4")

Width x Height	Plate No.	Price Ea.	Plate No.	Price Ea.
1-1/4" x 1/8"	4201F	\$109.00	4501F	\$109.00
1-1/4" x 1/4"	4202F	\$109.00	4502F	\$109.00
1-1/4" x 3/8"	4203F	\$121.00	4503F	\$121.00
1-1/4" x 1/2"	4204F	\$121.00	4504F	\$121.00
1-1/4" x 5/8"	4205F	\$121.00	4505F	\$121.00
3/4" x 1/2"	4206F	\$121.00	4506F	\$121.00
3/4" x 5/8"	4207F	\$137.00	4507F	\$137.00
3/4" x 3/4"	4208F	\$137.00	4508F	\$137.00

FILLER PLATES
M490/M490DE (12-1/2")
M490G Corrosion Resistant (11")

Width x Height	Plate No.	Price Ea.	Plate No.	Price Ea.
1-1/4" x 1/8"	4901F	\$109.00	49G1F	\$109.00
1-1/4" x 1/4"	4902F	\$109.00	49G2F	\$109.00
1-1/4" x 3/8"	4903F	\$121.00	49G3F	\$121.00
1-1/4" x 1/2"	4904F	\$121.00	49G4F	\$121.00
1-1/4" x 5/8"	4905F	\$121.00	49G5F	\$121.00
3/4" x 1/2"	4906F	\$121.00	49G6F	\$121.00
3/4" x 5/8"	4907F	\$137.00	49G7F	\$137.00
3/4" x 3/4"	4908F	\$137.00	49G8F	\$137.00

When ordering 422, 452 or 492 two Angle Brackets or Filler Plates are required. Double bracket part number is no longer available convert two single brackets.



Patent # 4,957,316

M490G GATE LOCK

with Limited Lifetime Warranty on Magnetic Coil Assembly

Standard features

- Includes - universal mounting brackets - for swinging or sliding gate
- Special corrosion-resistant finish
- 1/2" EMT compression fitting
- Built in voltage spike suppression
- Door Status Monitor
- Magnetic Bond Sensor
- ANSI/BHMA 156.23. Outdoor Rated - Certified for use -31° to 151° F (-35° to 66° C)

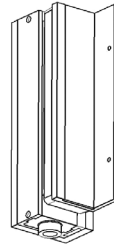

Sliding Gate

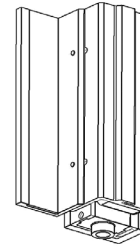

Swinging Gate

Note: Brackets for both applications included.

SPECIFICATIONS

M490G

Holding force	1500 lbs
Input voltage (standard unit)	12/24 VDC
Current draw (amps standard unit)	.65A @ 12 VDC
Dual voltage field selectable	.35A @ 24 VDC
Height	3"
Length	11"
Width	1-3/4"
Weight (approximate)	14 lbs

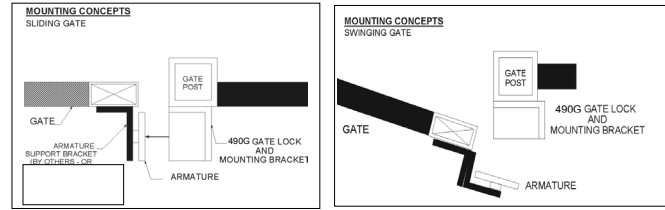

1. SELECT MODEL

M490G	Gate lock	\$1,080.00
-------	-----------	------------

320M MINILINE MAGNET LOCK

with Limited Lifetime Warranty on Magnetic Coil Assembly

Standard features

- Mortise mount for sliding doors
- Includes mounting tabs and armature mounting block
- Door Status Monitor and Magnetic Bond Sensor
- Adjustable relocking delay
- UL 10C listed; cUL
- CSFM California State Fire Marshal listed



SPECIFICATIONS

320M

Holding force	400 lbs. @ 12 VDC; 550 lbs. @ 24 VDC
Input voltage	12/24 VDC
Current draw	.23A @ 12 VDC
(Dual voltage field selectable)	.45A @ 24 VDC
Height	1-3/8"
Length	7"
Width	1-7/8"
Weight (approximate)	6 lbs

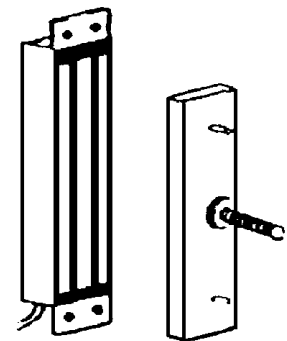

Note: For Wood Frames: Due to higher ambient operating temperatures, it is REQUIRED that the 12 VDC configuration be used.

1. SELECT MODEL

320M	Mini line	\$917.00
------	-----------	----------

CREDENTIALS
 READERS
 READER CONTROLLERS
 MULTI-FAMILY
 ENGAGE
 AD SERIES
 CO SERIES
 ELECTROMAGNETIC LOCKS
 POWER SUPPLIES
 VON DUPRIN ACCESS CONTROL
 SYSTEM ACC
 MISC



Patent # 6,611,414

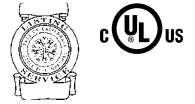

GF3000 SHEAR LOCK MORTISE SERIES with Limited Lifetime Warranty on Magnetic Coil Assembly

Standard features

- Microprocessor controlled
- Built-in Auto Relocking Switch (ARS)
- Jump 1/4" gap - no in-rush current (noticeable noise level when connecting)
- Automatic voltage selection 12 VDC or 24 VDC
- Cool temperature regulator
- Adjustable time delay: 2-30 sec. from face of magnet
- ANSI/BHMA 156.23
- UL 10C listed; cUL
- CSFM California State Fire Marshal listed

SPECIFICATIONS

Holding force	3000 lbs
Current draw	0.90A @ 12 VDC 0.45A @ 24 VDC
Lock size	9-1/2" L x 1-1/2" W x 1-1/2" H
Weight (approximate)	7 lbs
W/ mounting tabs	11-9/16" L x 1-1/2" W x 1-1/2" H
Armature	8-3/8" L x 1-3/8" W x 1/2" D
Armature bracket	10-5/8" L x 1-3/8" W x 1" D

Note: Filtered, regulated power supply recommended. See [PS900 Series Power Supplies](#).

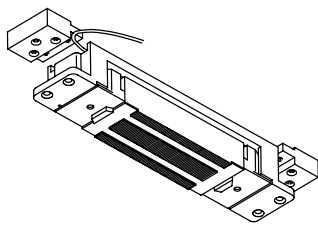

GF3000

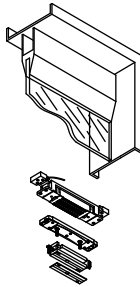

GF3000TRD

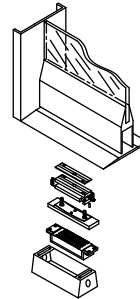

GF3000BRD

1. SELECT MODEL (NOT RECOMMENDED FOR WOOD DOORS)

GF3000	Standard unit ▪ Adjustable from top edge of door	\$1,710.00
GF3000TRD	Top rail door ▪ Mounting assembly which provides armature adjustment from latch edge of door ▪ Recommended with zero clearance condition between top of door and ceiling	\$2,349.00
GF3000BRD	Bottom rail door ▪ Mounting assembly to mortise armature into bottom rail of door ▪ Magnet is installed in floor/threshold ▪ Provides solution when no top rail is available	\$2,521.00

2. SELECT OPTIONS

DSM/MBS	Door Status Monitor/Magnetic Bond Sensor	\$419.00
---------	--	----------



GF3000 SHEAR LOCK SURFACE SERIES with Limited Lifetime Warranty on Magnetic Coil Assembly

Patent # 6,611,414

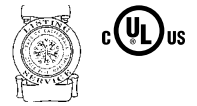

Standard features

- Microprocessor controlled
- Built-in Auto Relocking Switch (ARS)
- Jump 1/4" gap - no in-rush current (noticeable noise when connecting)
- Automatic voltage selection 12 VDC or 24 VDC
- Cool temperature regulator
- Adjustable time delay, 2-30 sec. from face of magnet
- Satin black, anodized housing (not available in special finishes)
- ANSI/BHMA 156.23
- UL 10C listed; cUL
- CSFM California State Fire Marshal listed

SPECIFICATIONS

Holding force	3000 lbs
Current draw	0.90A @ 12 VDC 0.45A @ 24 VDC
Lock housing	9-13/16" L x 1-1/4" W x 1-1/2" H
Armature housing	8-3/8" L x 1-3/8" W x 1/2" D
Weight (approximate)	9 lbs (SM, TJ suffix)

Note: Filtered, regulated power supply recommended See [900 Series Power Supplies](#).

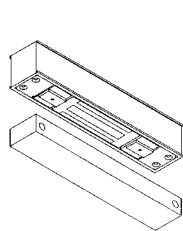

GF3000SM

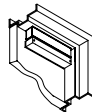

GF3000SM
(Outswinging)

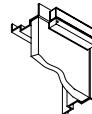

GF3000TJ
(Inswinging)

1. SELECT MODEL

GF3000SM	Standard unit (Outswinging doors) <ul style="list-style-type: none"> ▪ Adjustable from top edge of armature ▪ Finish plates available in 628 Satin Aluminum, Clear Anodized Finish 	\$2,084.00
GF3000TJ	Top jamb unit (Inswinging doors) <ul style="list-style-type: none"> ▪ Magnet mounts on inside top jamb ▪ Adjustable from top edge of armature ▪ Finish plates available in 628 Satin Aluminum, Clear Anodized Finish 	\$2,084.00

2. SELECT OPTIONS

DSM/MBS	Door Status Monitor/Magnetic Bond Sensor	\$419.00
---------	--	----------

Note: Housing available in Satin Black, Anodized (335) finish only.

CREDENTIALS
READERS
READER CONTROLLERS
MULTI-FAMILY
ENGAGE
AD SERIES
CO SERIES
ELECTROMAGNETIC LOCKS
POWER SUPPLIES
VON DUPRIN ACCESS CONTROL
SYSTEM ACC
MISC



PARTS AND ACCESSORIES

ELECTROMAGNETIC LOCK PARTS		
Description	Specify	Price
PCB Assembly basic with tape	P44488484	\$210.00
PCB Assembly plus with tape	P44488492	\$379.00
M490 Mounting plate	P23561665	\$102.00
M450 Mounting plate	P23561954	\$94.00
M420 Mounting plate	P23561962	\$85.00
M490 DEL 2 Cable assembly	P44487825	\$190.00
Sex nuts 5/16 inside thread - 1-3/4" door	P390498	\$26.00
Sex nuts 5/16 inside thread - 1-1/2" door	P390498-2	\$122.00
Sex nuts 5/16 inside thread - 2" door	P390498-5	\$169.00
Sex nuts 5/16 inside thread - 2-1/8" door	P390498-6	\$198.00
Sex nuts 5/16 inside thread - 2-1/4" door	P390498-7	\$198.00
Sex nuts 5/16 inside thread - 2-3/8" door	P390498-8	\$199.00
Sex nuts 5/16 inside thread - 2-1/2" door	P390498-9	\$200.00
Sex nuts 5/16 inside thread - 2-3/4" door	P390498-11	\$226.00
Armature TJ fastener pack	P44489342	\$25.00
Magnetic TJ fastener pack	P23566821	\$25.00
490 Armature mounting fastener pack	P44489110	\$34.00
450/420 Armature mounting fastener pack	P44489128	\$45.00
490/450 DBK - Double magnet connector kit (Screw mounting pack sold separate)	P44488377	\$122.00
420 DBK - Double magnet connector kit (Screw mounting pack sold separate)	P44488286	\$122.00
DE Cover security screw pack	P23879471	\$36.00
M450/490 Cover plate kit	P23841067	\$25.00
M420 Cover plate kit	P23841075	\$25.00
M420 Mag mounting pack	P23840283	\$25.00
M490/450 Mag mounting pack	P23840291	\$25.00
M490DE PCB Cover kit	P23840911	\$129.00
M490DE-S Cover kit	P23840929	\$117.00
M490DEP PCB Kit (:15 sec. delay)	P23840937	\$1,081.00
490G TJ Kit Assembly	P23688815	\$401.00
M490DEP PCB Kit (:30 sec. delay)	P47261542	\$1,111.00
M490DE PCB Kit (:15 sec. delay)	P23840945	\$869.00
M490DE PCB Kit (:30 sec. delay)	P47261543	\$869.00
M490DE Arm mount fast pack	P47244950	\$30.00
M490DE Cover plate assembly	P44487817	\$72.00
M490DEP BOCA PCB Kit (:15 sec. delay)	P23840952	\$469.00
M490DEP BOCA PCB Kit (:30 sec. delay)	P47261544	\$503.00
HDB Screw kit	P23841208	\$25.00
Screw pack - M400 Series filler plate - Angle bracket	P23850357	\$66.00
M490 Armature housing assembly	P23566359	\$133.00
M450 Armature housing assembly	P23561996	\$126.00
M420 Armature housing assembly	P23566888	\$123.00
M490 Armature	P23561707	\$379.00



PARTS AND ACCESSORIES

ELECTROMAGNETIC LOCK PARTS		
Description	Specify	Price
M450 Armature	P44489318	\$178.00
M420 Armature	P23562025	\$134.00
M490DEL Armature	P44487767	\$391.00
M490DE Basic remote (DE Remote only)	P44488443	\$2,196.00
M490DEP Plus Remote (DE Plus Remote only)	P44488468	\$3,214.00
GF3000 Armature mounting assembly TRD and BRD	P280037	\$284.00
GF3000BR Threshold box	P280043	\$56.00
GF3000BRD Armature assembly	P280052	\$193.00
GF3000BRD Mounting hardware pack	P280053	\$33.00
GF3000BRD Switch kit ARSM	P280055	\$54.00
GF3000 Magnet bracket	P280113	\$71.00
GF3000 Armature	P280120	\$190.00
GF3000 Armature bracket	P280124	\$60.00
GF3000 Control module	P280130-2	\$550.00
GF3000 Mounting hardware pack	P280135	\$97.00
GF3000TRD Armature assembly	P280147	\$248.00
GF3000BRD Connector assembly	P300000	\$17.00
GF3000 and TRD Connector assembly	P300001	\$360.00
GF3000 DSM Switch	P679024	\$238.00



Contents

Power supplies and option boards 271

PS902.....271

PS904271

PS906271

Option boards271

Customer service	Technical support
<ul style="list-style-type: none"> Order status Credit returns of non-defective products General sales questions <p>USA Allegion_Orders@allegion.com CAN Canada.CustomerService@allegion.com</p>	<ul style="list-style-type: none"> Technical questions/issues Returns of defective products Repairs <p>USA Electronic_Lock_TechProdSupport@allegion.com CAN Canada.TechServices@allegion.com</p>

CREDENTIALS

READERS

READER CONTROLLERS

MULTI-FAMILY

ENGAGE

AD SERIES

CO SERIES

ELECTROMAGNETIC LOCKS

POWER SUPPLIES

VON DUPRIN ACCESS CONTROL

SYSTEM ACC

MISC



1. SELECT POWER SUPPLY

Description	Specify	Price each
Base Power Supply (2A @ 12/24 VDC- field selectable) <ul style="list-style-type: none"> PS902 is able to accept a total of one optional distribution board, plus one fire alarm relay along with one battery backup board and up to two 7A/hr batteries 	PS902	\$371.00
Base Power Supply (4A @ 12/24 VDC- field selectable) <ul style="list-style-type: none"> PS904 is able to accept a total of two optional distribution boards, plus one battery backup board and up to two 7A/hr batteries 	PS904	\$702.00
Base Power Supply (6A @ 12/24 VDC- field selectable) <ul style="list-style-type: none"> PS906 is able to accept a total three optional distribution boards or two optional boards with battery backup board and two 7A/hr batteries 	PS906	\$1,087.00
"Buy America Act" compliant power supply option will be labeled as "Assembled in the U.S.A. with U.S. and foreign materials"	BAA ¹	\$57.00

- BAA compliant products must have the cover letter on page 306 included with the order. Failure to use this cover letter will result in the customer receiving non-BAA compliant product with no recourse for an RMA or refund. BAA compliant product requires a longer lead time, please contact customer service for details.
- When specifying power supply with "EL" or "QEL" Electric Latch Retraction devices, the 2RS is furnished when board option is not specified.

2. SELECT OPTIONAL DISTRIBUTION BOARD WITH OR WITHOUT FA (FIRE ALARM RELAY)

Description	Specify	Price each
Independently controlled relays	900-4R	\$250.00
Independently controlled relays with FA	900-4R-FA	\$342.00
2 Relay board output	900-2RS	\$254.00
2 Relay board output with FA	900-2RS-FA	\$346.00
4 Relay board integrated logic for controlling security interlocks, auto operators and time delays	900-4RL	\$688.00
4 Relay board integrated logic for controlling security interlocks, auto operators and time delays with FA	900-4RL-FA	\$780.00
8 fuse protected outputs	900-8F	\$92.00
8 fuse protected outputs with FA	900-8F-FA	\$184.00
8 PTC protected outputs	900-8P	\$92.00
8 PTC protected outputs with FA	900-8P-FA	\$184.00
Battery backup kit (includes two 7A/hr batteries)	900-BBK	\$359.00
Battery backup board only (sold separately)	900-BB	\$181.00
Batteries only - (two 7A/hr batteries, sold separately)	900-BAT	\$181.00

NOTE: For field installation, use model number. Example: 900-2RS.

3. SELECT OTHER POWER SUPPLY OPTIONS

Description	Specify	Price each
Fire alarm relay (EIR) module is a plug-in relay to provide an interface with fire or other emergency override systems <ul style="list-style-type: none"> PS902: May be installed directly on power supply or may be used with optional distribution boards. PS904, PS906: Must be used with optional distribution boards. If an optional board is not listed the 900-8F-FA will be provided. 	900-FA	\$92.00
Key lock cover (Not available with BAA)	900-KL	\$58.00

PS902, PS904, and PS906 power supplies require connection to AC line voltage. Installation and all electrical connections (high and low voltage) should be performed by a qualified electrical contractor.

Standard features

- UL294 Listed for Access Control
- Class 2 rated power limited output*
- Universal 120-240 VAC Input
- Regulated and filtered DC outputs
- AC input, battery and DC output LED indicators
- Plug and play connectors for optional distribution boards
- AC input status indication on outside cover
- AC monitoring
- 14" H x 12" W x 4" D enclosure

* PS906 is Class 2 when used with 900-8P option board

Contents

Power supplies 273
 PS914.....273
Delayed exit system 273
Electric power transfer 273
Von Duprin Remote Undogging (RU) and Remote Monitoring (RM) 273
Electric strikes 274
 4200 Series274
 5100 Series274
 6100 Series275
 6200 Series275
 6300 Series276
 6400 Series.....276

CREDENTIALS
 READERS
 READER CONTROLLERS
 MULTI-FAMILY
 ENGAGE
 AD SERIES
 CO SERIES
 ELECTROMAGNETIC LOCKS
 POWER SUPPLIES
 VON DUPRIN ACCESS CONTROL
 SYSTEM ACC
 MISC

Customer service	Technical support
<ul style="list-style-type: none"> Order status Credit returns of non-defective products General sales questions <p>USA Allegion_Orders@allegion.com CAN Canada.CustomerService@allegion.com</p>	<ul style="list-style-type: none"> Technical questions/issues Returns of defective products Repairs <p>USA Exits_TechProdSupport@allegion.com CAN Canada.TechServices@allegion.com</p>

For Von Duprin Access Control Products Warranty Information, please see the Von Duprin Exit Hardware and Parts book.

POWER SUPPLIES

See Von Duprin Exit Hardware and Parts price book

PS914 4A @ 12/24 VDC – field selectable

- Designed for high inrush current
- UL 294 Listed for Access Control
- Class 2 rated power limited output
- Universal 120-240 VAC input
- Regulated and filtered DC outputs
- LED indicators: AC input (visible on outside of enclosure) and DC output
- 2 connectors for optional distribution boards
- AC monitoring
- 14" H x 12" W x 4" enclosure

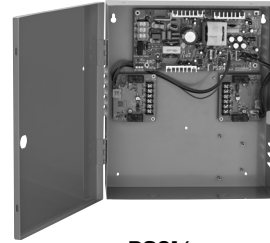

PS914

DELAYED EXIT SYSTEM

See Von Duprin Exit Hardware and Parts price book

DE5300 SERIES

- | | |
|-------------|---|
| Application | <ul style="list-style-type: none"> ▪ Designed to meet NFPA 101 "Special Locking Arrangement" applications ▪ Ideal for controlled areas ▪ Addresses life safety and security needs ▪ Commonly used on narrow stile doors where a standard narrow stile Chexit is not practical |
|-------------|---|

ELECTRIC POWER TRANSFER

See Von Duprin Exit Hardware and Parts price book

EPT

- | | |
|----------------|--|
| Application | <ul style="list-style-type: none"> ▪ Provide a means for transferring electrical power from a door frame to the edge of a swinging door ▪ Units are completely concealed when the door is in the closed position ▪ Ideally suited for applications involving abuse or heavy traffic |
| Popular models | <ul style="list-style-type: none"> ▪ EPT-2: Two 18 gauge wires; Up to 2 amps @ 24VDC, with a 16 AMP maximum surge ▪ EPT-10: Ten 24 gauge wires; Up to 1 amp @ 24VDC, with a 16 AMP maximum surge |

Additional electrified products available in the IVES price book and the LCN price book.

REMOTE UNDOGGING AND REMOTE MONITORING

Modular Retrofit Option for 98/99 and 33A/35A Series Devices

Description	Specify	Price
Remote Undogging (RU) 3' kit	47258681	\$1,397.00
Remote Undogging (RU) 4' kit	47258682	\$1,397.00
Remote Monitoring (RM) 3' kit	47258683	\$1,067.00
Remote Monitoring (RM) 4' kit	47258684	\$1,067.00

1. Access control managed via an IP or RS485 connection to the ENGAGE gateway through Allegion software alliance members, consult your access control software provider for specific scope of support.
2. ENGAGE™ gateway sold separately.
3. Compatible with 98/99 and 33A/35A series rim, SVR, CVR, CVC and 3-point devices.
4. Specify CON for Allegion Connect.

RU option:

- Enables both remote undogging and Door Status Monitoring (DPS, RX and LX)
- Not compatible with exit devices with the following options: QEL, DI/CDSI/HDSI, RX2, Schlage AD/CO Trim, SD, SS, PN, E-Strikes/Pullman Latch, CX
- Compatible device lengths: All 33A/35A and 98/99 device types – 3' (914 mm) length to 2' 9" (838 mm), 4' (1219 mm) length to 3' 3" (991 mm)

RM option:

- Enables Door Status Monitoring (DPS, RX and LX) only
- Not compatible with exit devices with the following options: DI/CDSI/HDSI, RX2, Schlage AD/CO Trim, SD, SS, PN, E-Strikes/Pullman Latch, CX
- If the door and exit device are fire rated, and the exit device type is a 98/99-F Rim manufactured prior to April 1, 2018, a new center case will be required before proceeding with the installation of the RM kit. 98/99-F Rim Center Case Kit Less Cover, part number 050026.

ELECTRIC STRIKES

Additional Electric Strikes available exclusively through Von Duprin. Please see Von Duprin price book for current list price information.

4200 SERIES

- Orderable through Schlage (ships from Security, CO) or Von Duprin (ships from Indianapolis, IN)

4200 SERIES ELECTRIC STRIKES FOR CYLINDRICAL AND DEADLATCH LOCKS										
Description	Throw	Fire rated	Hollow metal	Wood	Aluminum	Single	Mullion pair	Model	Finish	630
4211 - Shallow 1-3/8" backbox depth	1/2" – 3/4"		■		■	■		4211	.[Finish]	\$285.00
4212 - Includes latchbolt monitor. Shallow backbox.	1/2" – 5/8"		■		■	■		4212	.[Finish]	\$342.00

OPTIONS

OPTIONS (PLEASE SPECIFY)		Specify	Price each
SO12 Rectifier kit	Converts 12 VAC to 12 VDC	12 VAC	\$61.00
SO24 Rectifier kit	Converts 24 VAC to 24 VDC	24 VAC	\$61.00
Entry Buzzer	Use in fail-secure applications	EB	\$60.00
4200 Hardware kit	Includes mounting tab hardware, mounting screws, allen wrench and diode	050805	\$24.00
Faceplate, square corner		090114	\$30.00
Faceplate, round corner	Additional faceplate option, square corner is standard in the box, both in BHMA 630/US32D satin stainless steel finish	090110	\$30.00

NOTE: SO rectifier kit intended for fail secure / momentary use only. Contact product support for assistance. For additional parts list, please see Von Duprin price book.

Features

- Field selectable fail-safe/fail-secure without disassembly
- Dual voltage: 12 VDC at 200 mA / 24 VDC at 100 mA
- Compatible with all Schlage and Falcon cylindrical locks as well as cylindrical and deadlatch locks of many other manufacturers



5100 SERIES

- Orderable through Schlage (ships from Security, CO) or Von Duprin (ships from Indianapolis, IN)

5100 SERIES ELECTRIC STRIKE FOR CYLINDRICAL AND DEADLATCH LOCKS										
Description	Throw	Fire rated	Hollow metal	Wood	Aluminum	Single	Mullion pair	Model	Finish	Price
5100 - 3 faceplates included with hardware for an all-in-one boxed solution	1/2" – 5/8"		■	■	■	■		5100-3FP	.[Finish]	Please see Von Duprin price book for current list price information.

OPTIONS

OPTIONS (PLEASE SPECIFY)		Specify	Price each
SO12 Rectifier kit	Converts 12 VAC to 12 VDC	12 VAC	\$61.00
SO24 Rectifier kit	Converts 24 VAC to 24 VDC	24 VAC	\$61.00
Entry Buzzer	Use in fail-secure applications	EB	\$60.00

NOTE: SO rectifier kit intended for fail secure / momentary use only. Contact product support for assistance. For additional parts list, please see Von Duprin price book.

Features

- Adjustable keeper improves fit on tight door preps
- Field selectable fail-safe/fail-secure
- Dual voltage: 12 VDC at 380 mA / 24 VDC at 190 mA
- Compatible with Schlage and Falcon cylindrical and deadlatch locks including those of many other manufacturers
- UL 1034 burglary-resistant

ELECTRIC STRIKES

Additional Electric Strikes available exclusively through Von Duprin. Please see Von Duprin price book for current list price information.

6100 SERIES

- Orderable through Schlage (ships from Security, CO) or Von Duprin (ships from Indianapolis, IN)

6100 SERIES ELECTRIC STRIKES FOR RIM EXIT DEVICES										
Description	Throw	Fire rated	Hollow metal	Wood	Aluminum	Single	Mullion pair	Model	Finish	Price
6111 - Can use with vertical rod exit devices	3/4"	■	■	■	■	■		6111	.[Finish]	Please see Von Duprin price book for current list price information.
6112 - Designed to replace FA 310-5 with minor frame modification	3/4"	■	■	■	■	■		6112	.[Finish]	
6113 - Retrofits VD 3011, 3021	3/4"	■	■	■	■	■		6113	.[Finish]	
6114 - Surface applied for use with rim nightlatch devices	3/4"		■		■	■		6114	.[Finish]	
6121 - For rim exit devices on double doors without mullion ¹	3/4"		■	■	■		1	6121	.[Finish]	

1. For rim exit devices on double doors without mullion. For specified options and complete parts list, please see Von Duprin price book.

Features

- Furnished standard in fail secure configuration unless specified fail safe (see options)
- 24 VDC supplied standard if not specified otherwise (see options)
- Compatible with Von Duprin and Falcon rim exit devices and those of many other manufacturers
- UL10C fire rated (fail secure only)
- UL1034 burglary-resistant

6200 SERIES

- Orderable through Schlage (ships from Security, CO) or Von Duprin (ships from Indianapolis, IN)

6200 SERIES ELECTRIC STRIKES FOR MORTISE OR CYLINDRICAL LOCKS										
Description	Throw	Fire rated	Hollow metal	Wood	Aluminum	Single	Mullion pair	Model	Finish	Price
6210 - Mortise only. Includes strike pocket inserts for deadlocking triggers	3/4"	■	■		■	■		6210	.[Finish]	Please see Von Duprin price book for current list price information.
6211 - Retrofits VD 3140 or FA 712	3/4"	■	■		■	■		6211	.[Finish]	
6211AL - Retrofits FA 722	3/4"	■			■	■		6211AL	.[Finish]	
6211WF - Retrofits FA 732 with minor frame modification	3/4"	■		■		■		6211WF	.[Finish]	
6212 - Fits modified ANSI 115.2 cutout. Retrofits VD 3146.	3/4"	■	■	Retrofits only	■	■		6212	.[Finish]	
6212WF	3/4"	■		■		■		6212WF	.[Finish]	
6213 - Retrofits VD 3041, 3042, 3061 and 3062	3/4"	■	■		■	■		6213	.[Finish]	
6214 - Retrofits FA 310-2 3/4	3/4"	■	■		■	■		6214	.[Finish]	
6215 - Retrofits FA 310-2	3/4"	■	■		■	■		6215	.[Finish]	
6216 - Retrofits FA 310-3-1. For mortise with manually operated deadbolt - 1" throw	3/4"	■	■	■	■	■		6216	.[Finish]	
6221 - Retrofits VD 3071 and 3072. 4-3/4" minimum stile required	3/4"	■	■	■	■		■	6221	.[Finish]	
6222 - Retrofits FA 310-2 3/4 OB	3/4"	■	■		■		■	6222	.[Finish]	
6223 - Retrofits VD 3091 and 3092. 4-3/4" minimum stile required	3/4"	■	■	■	■		■	6223	.[Finish]	
6224 - Retrofits FA 310-2 3/4. For door thicknesses 1-3/4" or 2-1/4"	3/4"	■	■		■		■	6224	.[Finish]	
6224AL - Retrofits FA 310-2RF. For door thicknesses 1-3/4" or 2-1/4"	3/4"	■			■		■	6224AL	.[Finish]	
6225 - Retrofits FA 310-2 OB	3/4"	■	■		■		■	6225	.[Finish]	
6226 - Retrofits FA 310-2. For door thicknesses 1-3/4" or 2-1/4"	3/4"	■	■		■		■	6226	.[Finish]	

For specified options and complete parts list, please see Von Duprin price book.

Features

- Furnished standard in fail secure configuration unless specified fail safe (see Von Duprin price book for options)
- 24 VDC supplied standard if not specified otherwise (see Von Duprin price book for options)
- Compatible with mortise (without deadbolt) and cylindrical lock applications except where noted
- ANSI/BHMA 156.31 Grade 1: 6210, 6211, 6211AL, and 6211WF
- UL10C fire rated (fail secure only)
- UL1034 burglary-resistant

ELECTRIC STRIKES

Additional Electric Strikes available exclusively through Von Duprin. Please see Von Duprin price book for current list price information.

6300 SERIES

- Orderable through Schlage (ships from Security, CO) or Von Duprin (ships from Indianapolis, IN)

6400 SERIES MODULAR ELECTRIC STRIKE FOR MORTISE OR CYLINDRICAL LOCKS										
Description	Throw	Fire rated	Hollow metal	Wood	Aluminum	Single	Mullion pair	Model	Finish	Price
6300 - No cut, surface mount design	Up to 3/4"	■	■	■	■	■	■	6300	.[Finish]	Please see Von Duprin price book for current list price information.

For specified options and complete parts list, please see Von Duprin price book.

Features

- Dual voltage: 12 VDC at 500 mA / 24 VDC at 240 mA
- UL 1034, UL 294, CSFM
- Compatible with most rim exit devices
- UL 10C 3-hour fire rated (fail secure only)

6400 SERIES

- Orderable through Schlage (ships from Security, CO) or Von Duprin (ships from Indianapolis, IN)

6400 SERIES MODULAR ELECTRIC STRIKE FOR MORTISE OR CYLINDRICAL LOCKS										
Description	Throw	Fire rated	Hollow metal	Wood	Aluminum	Single	Mullion pair	Model	Finish	630
6400 - Up to 1" deadbolt throw (must be manually retracted and extended)	Up to 3/4"	■	■	■	■	■		6400	.[Finish]	\$774.00

OPTIONS

OPTIONS (PLEASE SPECIFY)		Specify	Price each
Latch monitor	Optional plug-in latch monitor can be added in the field	LM6400	\$82.00
SO12 Rectifier kit	Converts 12 VAC to 12 VDC	12 VAC	\$61.00
SO24 Rectifier kit	Converts 24 VAC to 24 VDC	24 VAC	\$61.00
Entry Buzzer	Use in fail-secure applications	EB	\$60.00

Included with strike: two plug-in voltage connectors, self-adhesive template for frame cuts, trim filler plate, mounting tabs and shims, as well as tamper-resistant screws with a security driver bit.

NOTE: SO rectifier kit intended for fail secure / momentary use only. Contact product support for assistance.

For additional parts list, please see Von Duprin price book.

Features

- Dual voltage: 12 VDC at 375 mA / 24 VDC at 190 mA
- UL 1034, UL 294, CSFM
- Modular options fit cylindrical and nearly any mortise lock
- 3-hour fire rated to UL 10C (fail secure only)
- Includes movable deadbolt keeper, plug and deadlatch ramp inserts



Contents

Consoles and monitoring stations	278
8200 Series	278
800 Series.....	278
Electronic access releasing devices.....	279
672 TouchBar	279
692 SmartBar	280
672 TouchBar/692 SmartBar Parts.....	281
600 Series Heavy duty pushbuttons.....	282
600 Series Heavy duty pushbutton parts.....	283
700 Series Entry level pushbutton	284
650 Series Heavy duty keyswitches	285
650 Series Heavy duty keyswitch parts.....	286
Specialty equipment.....	287
Door position switches.....	287
Door cords.....	287
Accessories	288
Electronic horns.....	288
Scanners/PIRs.....	288
740 Series Emergency break glass.....	288
660 Series Surface mini box	288
Electromechanical locks	289
442S Series Cabinet lock	289
PB405-PB405S PowerBolts	289

Customer service	Technical support
<ul style="list-style-type: none"> ▪ Order status ▪ Credit returns of non-defective products ▪ General sales questions <p>USA Allegion_Orders@allegion.com CAN Canada.CustomerService@allegion.com</p>	<ul style="list-style-type: none"> ▪ Technical questions/issues ▪ Returns of defective products ▪ Repairs <p>USA Electronic_Lock_TechProdSupport@allegion.com CAN Canada.TechServices@allegion.com</p>



8200 SERIES

Consoles

Features

- Slope front design, with anodized face plate and durable housing
- Each station provides maintained or momentary SPDT pushbutton switch
- Red and green indicator lamps
- Security keyswitch
- Signaling horn
- Alarm reset button
- 24 VDC operation
- UL 294 listed for access control system

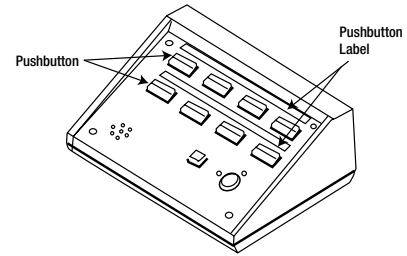

4 or 8 zone console

SELECT MODEL

1. Select model - last digit indicates # of zones and select pushbutton function by zone
2. Specify a switch for each zone; M (momentary) or A (alternate action, maintained)

	ZONE	1	2	3	4	5	6	7	8	
8204		-	-	-	-					\$2,042.00
8208		-	-	-	-	-	-	-	-	\$3,595.00

REPLACEMENT PARTS

8200MS	Momentary switch assembly	\$231.00
8200AS	Alternate Action (maintained) switch assembly	\$231.00
P810033	8 Zone PCB assembly	\$361.00
P810049	Console silence button	\$126.00
P810050	Console keyswitch	\$142.00

800 SERIES

Remote and local monitoring stations

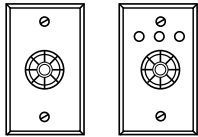

800A

801

SELECT MODEL

800A	Remote monitoring - audible sound, 70 dB @ 2ft	\$230.00
800L1	Local monitoring - one LED indicator - red, green or amber	\$116.00
800L2	Two LED indicators - red, green or amber	\$158.00
801	Local or remote monitoring station <ul style="list-style-type: none"> ▪ Requires MBS option on locking device 	\$424.00
801KS	Local or remote monitoring station with keyswitch (less cylinder) <ul style="list-style-type: none"> ▪ For Legal Release and Reset feature (requires MBS on locking device) ▪ SPDT momentary x SPDT maintained contact arrangement 	\$1,122.00



672 TOUCHBAR

Patent Issued

The 672 TouchBar is a request-to-exit device used to release electromagnetic locks. Designed for easy installation, smooth operation, and maximum durability.



Standard features

- Pushpad with "PUSH TO EXIT" signage
- 1/4" Movement to activate switch
- Heavy-duty aluminum extrusion and powder coated zinc end caps
- Double pole, double throw switch
- UL 294 listed for access control system
- Universal mounting system for aluminum, hollow metal and wood doors (Includes self-drilling, self-tapping screws for aluminum or wood door application: RIV nuts for hollow metal door applications)
- Field reversible

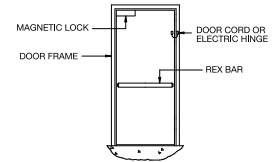

REX Bar Application



1. SELECT MODEL

672	For aluminum, hollow metal and wood doors	\$544.00
-----	---	----------

2. SELECT DOOR SIZE

36", 42" or 48"	Standard door width	Standard
-----------------	---------------------	----------

3. SELECT FINISH

628	Clear Anodized Aluminum	Standard
313	Dark Satin Bronze Anodized Aluminum	\$51.00

4. SELECT PUSHPAD

RD	Black pushpad with Red letters "PUSH TO EXIT"	Standard
GID	Black pushpad with Glow-In-The-Dark letters "PUSH TO EXIT"	No charge

5. SELECT HANDING

RHR	Right hand reverse	Standard
LHR	Left hand reverse	No charge

6. SELECT OPTION/ACCESSORY

AR	798-18, 18" x 1/2" Armored door cord (less wires) in/out swinging	\$97.00
WD	Sexnut door kit for heavy-duty wood door and hollow metal door applications (includes 4 sex bolts and screws)	\$127.00
SHK	Aluminum door mounting shim kit (Includes brackets/shims and screws)	\$127.00

See 672 TouchBar Parts on page 281.

Specifications

Mechanical

- Available in standard lengths to fit 36", 42" and 48" doors
- Can also be field cut at the installation site for custom lengths

Electrical

- Switch: DPDT contacts rated 4A @ 30 VDC
- Wiring: 6 Conductor Cable - 20 AWG (standard)

692 SMARTBAR

Patent Issued

The 692 TouchBar is a request-to-exit device with no moving parts used to release electromagnetic locks. Designed for easy installation, smooth operation and maximum durability.



Standard features

- Push pad with "PUSH TO EXIT" signage
- Touch any point on the pushpad to release locking device
- Audible alarm
- Heavy duty aluminum extrusion and powder coated zinc end caps
- Directionally opposed infrared detection circuits
- DPDT relay
- Universal mounting system for aluminum, hollow metal and wood doors (Includes self-drilling, self-tapping screws for aluminum or wood door application: RIV nuts for hollow metal door applications)
- 798-18, 18" x 1/2" Armored door cord (798-18) shipped standard
- UL 294 listed for access control system



1. SELECT MODEL

692	For aluminum, hollow metal and wood doors	\$975.00
-----	---	----------

2. SELECT DOOR SIZE

36", 42" or 48"	Standard door width	Standard
-----------------	---------------------	----------

3. SELECT FINISH

628	Clear Anodized Aluminum	Standard
313	Dark Satin Bronze Anodized Aluminum	\$51.00

4. SELECT PUSHPAD

RD	Black pushpad with RED letters "PUSH TO EXIT"	Standard
GID	Black pushpad with Glow-In-The-Dark letters "PUSH TO EXIT"	No charge

5. SELECT HANDING

RHR	Right hand reverse	Standard
LHR	Left hand reverse	No charge

6. SELECT OPTION/ACCESSORY

WD	Sexnut door kit (for heavy-duty wood door and hollow metal door applications)	\$127.00
SHK	Aluminum door mounting shim kit (Includes brackets/shims and screws)	\$127.00

See 692 SmartBar Parts on page 281.

Specifications

Mechanical

- Available in standard lengths to fit 36", 42" and 48" doors
- Can also be field cut at the installation site

Electrical

- Input voltage: 12 or 24 VDC. Maximum current draw .50A
- Contact rating: 4A @ 30 VDC
- Wiring: 8 Conductor Cable - 20 AWG - 6 ft long

PARTS AND ACCESSORIES

672 / 692 SHARED PARTS		
Description	Specify	Price
672/692 Channel end cap bracket	P972797	\$150.00
Exit insert - Red	P972792	\$142.00
Exit plate - Black	P972791	\$142.00
672/692 Mounting screw pack	P900256	\$142.00
REX SNB kit, 630 (US32D), quantity of 4	P900257-628	\$142.00
REX SNB kit, 695 (SP313)	P900257-313	\$142.00
Spacer adapter - Black	P900275-BLK	\$169.00
Spacer adapter - Gray	P900275-GRY	\$169.00
Standard pushbar - 36" - 313	P972772-313	\$243.00
Standard pushbar - 36" - 628	P972772-628	\$243.00
Standard pushbar - 42" - 313	P972773-313	\$243.00
Standard pushbar - 42" - 628	P972773-628	\$243.00
Standard pushbar - 48" - 313	P972774-313	\$243.00
Standard pushbar - 48" - 628	P972774-628	\$243.00

672 PARTS		
Description	Specify	Price
672 Cover plate - 36"- 628	P972766-628	\$184.00
672 Cover plate - 42"- 313	P972767-313	\$184.00
672 Cover plate - 42"- 628	P972767-628	\$184.00
672 Cover plate - 48"- 313	P972768-313	\$184.00
672 Cover plate - 48"- 628	P972768-628	\$184.00
672 Channel end cap - Black 672	P972784-BLK	\$151.00
672 Channel end cap	P972784-GRY	\$151.00
PCB Assembly DPDT 672	P114281	\$302.00

692 PARTS		
Description	Specify	Price
692 Beam housing assembly - Black	P692001	\$259.00
Control board assembly - 692	P114285	\$506.00
692 Cover plate - 36"- 313	P972769-313	\$184.00
692 Cover plate - 36"- 628	P972769-628	\$184.00
692 Cover plate - 42"- 313	P972770-313	\$184.00
692 Cover plate - 42"- 628	P972770-628	\$184.00
692 Cover plate - 48"- 313	P972771-313	\$184.00
692 Cover plate - 48"- 628	P972771-628	\$184.00
692 Wire harness - 6 Ft	P114287	\$193.00
End Cap PCB cable assembly - 692	P114284	\$151.00

600 SERIES

Heavy duty pushbuttons

- 3A@30 VDC, Momentary (Standard) contacts
- UL 294 listed for access control system

1. SELECT MODEL					
Model number	Cover plate	Cone	Button		Price
621AL	Stainless steel 2-3/4" x 4-1/2"	Plastic Translucent	1-1/4"	Aluminum	\$319.00
621ALEX				Alum. "Push to Exit" engraved	\$319.00
621ALRDEX				Alum. (red coated), "Push to Exit" engraved	\$319.00
621BLH				Blue handicapped symbol	\$256.00
621BK				Black	\$256.00
621GR				Green	\$256.00
621GREX				Green "Push to Exit"	\$256.00
621RD				Red	\$256.00
621RDEX				Red "Push to Exit"	\$256.00
621GID				Glow-in-the-Dark	\$256.00
621GIDEX				Glow-in-the-Dark "Push to Exit"	\$256.00
623BLH				Stainless steel 2-3/4" x 4-1/2"	Plastic Translucent
623BK	Black	\$256.00			
623GR	Green	\$256.00			
623GREX	Green "Push to Exit"	\$256.00			
623RD	Red	\$256.00			
623RDEX	Red "Push to Exit"	\$256.00			
623GID	Glow-in-the-Dark	\$256.00			
623GIDEX	Glow-in-the-Dark "Push to Exit"	\$256.00			
625BLH	Stainless steel 2-3/4" x 4-1/2"	Plastic Translucent	2-3/4"	Blue handicapped symbol	\$256.00
625BK				Black	\$256.00
625GR				Green	\$256.00
625GREX				Green "Push to Exit"	\$256.00
625RD				Red	\$256.00
625RDEX				Red "Push to Exit"	\$256.00
631AL ¹	Cast zinc	Zinc	1-1/4"	Aluminum	\$469.00
631ALEX ¹	2-3/4" x 4-1/2"			Aluminum "Push to Exit" engraved	\$470.00
631ALRDEX ¹	Extreme duty			Aluminum (red coated) "Push to Exit" engraved silver	\$470.00

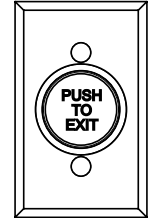

621, 623



621-NS, 623-NS

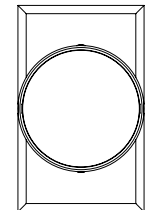

625



625-NS

1. Not available in special finishes.

2. SELECT OPTIONS		
DA	Delayed pneumatic action (3A @ 30 VDC, form Z contacts)	\$699.00
NS	Narrow stile - Stainless steel plate (1-3/4" x 4-1/2")	No charge
AA	Alternate action/maintained (3A @ 30VDC)	No charge
L2/ILL	LEDs for glow thru cone for 621 and 623 models (12-24 VDC .025A @ 28VDC)	\$103.00
DP	DPDT - Double pole, double throw (not available with DA option)	\$51.00

3. SELECT FINISH - HEAVY DUTY PLATE (HDP INCLUDED - REQUIRED FOR SPECIAL FINISH)		
630	BHMA 630 (US32D) on .035 Satin Stainless Steel	Standard
SF-613	Oil Rubbed Bronze on heavy-duty zinc	\$224.00
SF-625	Bright Chrome on heavy-duty zinc	\$224.00
SF-626	Satin Chrome on heavy-duty zinc (standard on 631 models)	\$88.00

CREDENTIALS
READERS
READER CONTROLLERS
MULTI-FAMILY
ENGAGE
AD SERIES
CO SERIES
ELECTROMAGNETIC LOCKS
POWER SUPPLIES
VON DUPRIN ACCESS CONTROL
SYSTEM ACC
MISC



PARTS AND ACCESSORIES

PCB ASSEMBLY ONLY		
Description	Specify	Price
DPDT - PC Board assembly	P620009-1	\$119.00
SPDT - PC Board assembly	P620009	\$67.00
L2/ILL - PC Board assembly	P395362	\$104.00
621 BUTTON ONLY		
Description	Specify	Price
Button 1-1/4" Metal	P620136	\$64.00
Button 1-1/4" Metal "Push to Exit"	P620026-1	\$64.00
Button 1-1/4" Blue Handicap	P620092-BL	\$45.00
Button 1-1/4" Black	P620090-BK	\$45.00
Button 1-1/4" GID	P620090-GID	\$45.00
Button 1-1/4" Green	P620090-GR	\$45.00
Button 1-1/4" Red	P620090-RD	\$45.00
Button 1-1/4" GID	P620091-GID	\$45.00
Button 1-1/4" Green	P620091-GR	\$45.00
Button 1-1/4" Red	P620091-RD	\$45.00
623 BUTTON ONLY		
Description	Specify	Price
Button 1-5/8" Blue Handicap	P620032-BL	\$45.00
Button 1-5/8" GID	P620014-GID	\$45.00
Button 1-5/8" GID "Push to Exit"	P620031-GID	\$45.00
Button 1-5/8" Green	P620014-GR	\$45.00
Button 1-5/8" Green "Push to Exit"	P620031-GR	\$45.00
Button 1-5/8" Red	P620014-RD	\$45.00
Button 1-5/8" Red "Push to Exit"	P620031-RD	\$45.00
Button 1-5/8" Black	P620014-BK	\$45.00
625 BUTTON ONLY		
Description	Specify	Price
Button 2-3/4" Black	P620029-BK	\$45.00
Button 2-3/4" Blue Handicap	P620027-BL	\$45.00
Button 2-3/4" Green	P620029-GR	\$45.00
Button 2-3/4" Green "Push to Exit"	P620028-GR	\$45.00
Button 2-3/4" Red	P620029-RD	\$45.00
Button 2-3/4" Red "Push to Exit"	P620028-RD	\$45.00
FACEPLATES ONLY		
Description	Specify	Price
Heavy duty plate - 613 Dark Satin Bronze	P620008-613	\$224.00
Heavy duty plate - 625 Bright Chrome	P620008-625	\$224.00
Heavy duty plate - 626 Satin Chrome	P620008-626	\$82.00
Heavy duty plate narrow - 613 Dark Satin Bronze	P620020-613	\$224.00
Heavy duty plate narrow - 625 Bright Chrome	P620020-625	\$224.00
Heavy duty plate narrow - 626 Satin Chrome	P620020-626	\$88.00
Plate narrow - Stainless Steel	P620088	\$87.00
Plate single gang - Stainless Steel	P620033	\$87.00

CREDENTIALS
READERS
READER CONTROLLERS
MULTI-FAMILY
ENGAGE
AD SERIES
CO SERIES
ELECTROMAGNETIC LOCKS
POWER SUPPLIES
VON DUPRIN ACCESS CONTROL
SYSTEM ACC
MISC

700 SERIES

Entry level pushbutton

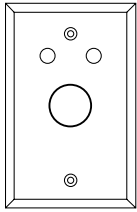

701RD-L2

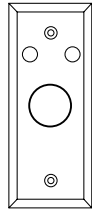

701RD-NS-L2



709BLH ILL-L2

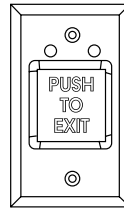

709RD EX ILL-L2

Specifications

Output contact rating:

- 701 Series 3A @ 30 VAC/VDC, momentary SPDT contacts
- 709 Series 5A @ 30 VAC/VDC, momentary SPDT contacts
- UL 294 listed for access control system

1. SELECT MODEL			
Model number	Cover plate	Button	Price
701RD	Stainless steel only 2-3/4" x 4-1/2"	Red 7/8"	\$209.00
701BK		Black 7/8"	\$209.00
701RDEX		Red 5/8" Engraved "Push to Exit"	\$209.00
701RDEXILL		Red 5/8" Illuminated "Push to Exit"	\$251.00
709RDEXILL ¹	Stainless steel only 2-3/4" x 4-1/2"	Red 2" sq Illuminated "Push to Exit"	\$243.00
709GREXILL ¹		Green 2" sq Illuminated "Push to Exit"	\$243.00
709BLHILL ¹		Blue 2" sq Illuminated handicapped symbol	\$243.00

2. SELECT OPTIONS		
L2	Two LEDs, red or green, dual voltage	\$103.00
AA ²	Alternate action	\$32.00
NS ³	Narrow stile plate	No charge

1. Must specify 12 VDC or 24 VDC when ordering 709 Series Pushbuttons.
2. Maintained for 701 Series only.
3. For 701 Series only.

PARTS		
Description	Specify	Price
701 Button 7/8" - Red	P100682	\$63.00
701 Button 7/8" - Black	P100688	\$63.00
701 Narrow Stainless Steel plate	P701629	\$50.00
701 Stainless Steel plate	P701607	\$50.00
701 Stainless Steel plate L2	P701628	\$50.00

650 SERIES
Heavy duty keyswitches

- Patented magnetic spring design
- Momentary to maintained functions
- 5A @ 30 VDC, SPDT contacts
- Standard faceplate finish 630 Stainless Steel
- UL 294 listed for access control system

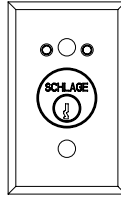

653-04-L2



653-04-L2-NS

Note: 650 Series Keyswitches operate with either a 1-1/8" or 1-1/4" cylinder having a straight type cam. 1-1/4" Cylinders require a 1/8" blocking / spacer ring (included with the CYL and CYL-KA options). Cannot be used with cylinder and/or collar greater than 1-3/8".

1. SELECT KEYSWITCH FUNCTION			
Model number	Description	Cover plate	Price
653-04	SPDT maintained single direction - Stainless Steel	2-3/4" x 4-1/2"	\$341.00
653-05	SPDT momentary single direction - Stainless Steel	2-3/4" x 4-1/2"	\$341.00
653-14	DPDT maintained single direction - Stainless Steel	2-3/4" x 4-1/2"	\$394.00
653-15	DPDT momentary single direction - Stainless Steel	2-3/4" x 4-1/2"	\$394.00
653-1414	(2) DPDT maintained bi-direction - Stainless Steel	2-3/4" x 4-1/2"	\$521.00
653-1415	DPDT maintained x DPDT momentary - Stainless Steel	2-3/4" x 4-1/2"	\$521.00
653-1515	(2) DPDT momentary bi-direction - Stainless Steel	2-3/4" x 4-1/2"	\$521.00
653-041	SPDT maintained x key remove one position - Stainless Steel	2-3/4" x 4-1/2"	\$341.00
653-0404	(2) SPDT maintained bi-direction - Stainless Steel	2-3/4" x 4-1/2"	\$394.00
653-0405	SPDT maintained x SPDT momentary - Stainless Steel	2-3/4" x 4-1/2"	\$394.00
653-141	DPDT maintained x key remove one position - Stainless Steel	2-3/4" x 4-1/2"	\$394.00
653-0505	(2) SPDT momentary bi-direction - Stainless Steel	2-3/4" x 4-1/2"	\$394.00

2. SELECT OPTIONS - (CYL OR CYL-KA MUST BE CHOSEN TO RECEIVE A CORE)		
L2	Two LEDs (red/green), dual voltage 12/24 VDC	\$103.00
NS	Narrow stile - Stainless Steel Plate (1-3/4" x 4-1/2")	No charge
ATS	Anti-Tamper Switch	\$97.00
WP	Water resistant cover fits 1-1/8" cylinder only (not available with NS or L2 or special finishes)	\$123.00
CYL	1-1/4" Schlage Everest mortise cylinder with two keys and 1/8" spacer ring	\$116.00
CYL-KA (keyed alike)	1-1/4" Schlage Everest mortise cylinder with two keys and 1/8" spacer ring	\$116.00

3. SELECT PLATE FINISH		
630	BHMA 630 (US32D) on .035 Satin Stainless Steel	Standard
SF-613	Oil Rubbed Bronze on heavy-duty zinc	\$224.00
SF-625	Bright Chrome on heavy-duty zinc	\$224.00
SF-626	Satin Chrome on heavy-duty zinc	\$88.00

4. SELECT OPTIONAL BLOCKING RING - (ONLY NECESSARY WHEN USING WITH A COMPETITIVE CYLINDER)		
36-079	Blocking ring for use without compression ring	\$20.00

5. SPECIFY BLOCKING RING SIZE - (EXAMPLE: 36-079-012)	
012	1/8" length
018	3/16" length
025	1/4" length
031	5/16" length
037	3/8" length
043	7/16" length
050	1/2" length



PARTS AND ACCESSORIES

MOUNTING HARDWARE ONLY		
Description	Specify	Price
Heavy duty mounting hardware - 613 Dark Satin Bronze	P630013-613	\$37.00
Heavy duty mounting hardware - 625 Bright Chrome	P630013-625	\$37.00
Heavy duty mounting hardware - 626 Satin Chrome	P630013	\$18.00

SINGLE GANG FACEPLATE ONLY		
Description	Specify	Price
Standard plate - Stainless Steel	P653063	\$88.00
Heavy duty plate - 613 Dark Satin Bronze	P653009-613	\$224.00
Heavy duty plate - 625 Bright Chrome	P653009-625	\$224.00
Heavy duty plate - 626 Satin Chrome	P653009-626	\$88.00
Standard plate - Stainless Steel - L2	P653064	\$88.00
Heavy duty plate - L2 - 613 Dark Satin Bronze	P653015-613	\$224.00
Heavy duty plate - L2 - 625 Bright Chrome	P653015-625	\$224.00
Heavy duty plate - L2 - 626 Satin Chrome	P653015-626	\$88.00

NARROW FACEPLATE ONLY		
Description	Specify	Price
Standard plate narrow - Stainless Steel	P653065	\$88.00
Heavy duty plate narrow - 613 Dark Satin Bronze	P653026-613	\$224.00
Heavy duty plate narrow - 625 Bright Chrome	P653026-625	\$224.00
Heavy duty plate narrow - 626 Satin Chrome	P653026-626	\$87.00
Standard plate narrow - Stainless Steel - L2	P653066	\$180.00
Heavy duty plate narrow - L2 - 613 Dark Satin Bronze	P653027-613	\$224.00
Heavy duty plate narrow - L2 - 625 Bright Chrome	P653027-625	\$224.00
Heavy duty plate narrow - L2 - 626 Satin Chrome	P653027-626	\$88.00

SWITCHES ONLY		
Description	Specify	Price
Anti-Tamper Switch and magnet	P653067	\$36.00
Switch and lead assembly	P653059	\$45.00

DOOR POSITION MONITORS AND SWITCHES

FSS1 HIGH SECURITY DOOR POSITION MONITOR - (UL 634 LEVEL 2 RATING)		
Model number	Description	Price
194555101647	FSS1 High security DPS surface mount with conduit	\$1,049.00
194555101654	FSS1 High security DPS surface mount without conduit	\$1,049.00
194555101661	FSS1 High security DPS flush mount mortised	\$1,049.00

DOOR POSITION SWITCHES		
Model number	Description	Price
674-OH	Overhead door floor mount	\$428.00

679 SERIES CONCEALED SPDT MAGNETIC SWITCH (0.3A @ 30 VDC)		
Model number	Description	Price
679-05	Wood door and frame	\$93.00
679-05HM	HM Hollow metal door and frame	\$129.00
679-05WD	WD Wood door and metal frame	\$154.00

7700 SERIES DOOR POSITION SWITCHES (0.25A @ 30 VDC)		
Model number	Description	Price
7764	Concealed / flush mount	\$311.00
7766	Surface mount	\$330.00

DOOR CORDS		
Model number	Description	Price
788-12	12" x 3/8" Armored door cord - less wires	\$101.00
788C-12	12" x 3/8" Armored door cord with 20" 4-conductor wire	\$154.00
788-18	18" x 3/8" Armored door cord - less wires	\$134.00
788C-18	18" x 3/8" Armored door cord with 26" 4-conductor wire	\$181.00
798-12	12" x 1/2" Armored door cord - less wires	\$117.00
798C-12	12" x 1/2" Armored door cord with 20" 4-conductor wire	\$154.00
798-18	18" x 1/2" Armored door cord - less wires	\$148.00
798C-18	18" x 1/2" Armored door cord with 26" 4-conductor wire	\$181.00

Notes: C Suffix = 20 AWG wires
 Classified by UL to UL 10C

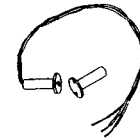

679-05 Concealed SPDT magnetic switch

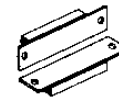

7764 Concealed door position switch

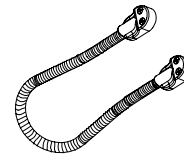

Door cord

ELECTRONIC HORNS

- Immediate, local audible warning device
- Designed for indoor application
- Surface and flush mounting kits included with all horns
- Latching units require a reset action
- Strobe units activate / deactivate based on the state of the horn
- Horn color is white
- Dual decibel settings high/low 102 and 88 with dba's

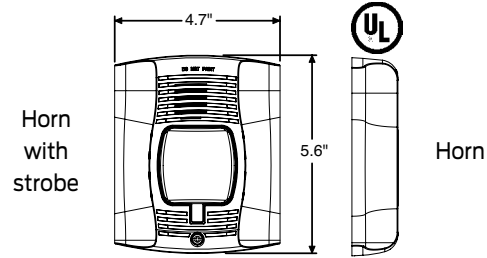

1. SELECT MODEL		
Model number	Description	Price
1910-1	12/24 VDC Horn, current draw 14 mA @ 12 VDC; 28 mA @ 24 VDC	\$697.00
1910S-1	24 VDC Horn with strobe, current draw 71mA	\$949.00
L1910-1	24 VDC Horn with latching, current draw 28mA	\$963.00
L1910S-1	24 VDC Horn with strobe and latching, current draw 71mA	\$1,258.00

SCANNERS/PIRS

- Passive infrared detector
- Surface Mounting height range is from 7 to 15 ft
- Two form "C" relay contacts rated 2A @ 30 VDC for DC resistive loads
- Relay latch time is adjustable up to 64 seconds
- UL 294 listed by manufacturer as an access control device
- Designed for indoor applications

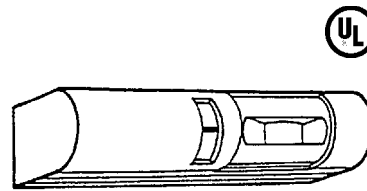

SCAN II-W

1. SELECT MODEL		
Model number	Description	Price
Scan II - B	Black	\$822.00
Scan II - W	White	\$822.00

740 SERIES EMERGENCY BREAK GLASS

Switch contact form "Z", rated 6A @ 30 VDC

Model number	Description	Price
740	Assembly only	\$587.00
741	With indicator light	\$600.00
742	With Sonalert	\$653.00

Assembly mounts in 3 gang electrical box.

P800003 is the part number for the 5 pack of glass disc replacements. List \$132.00.

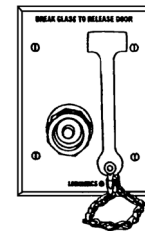

740

660 SERIES SURFACE MINI BOX

Dimensions: 2" H x 2" W x 1" D

Switch contact rating: 6A @ 120 VAC

Model number	Description	Price
660-PB	SPDT Momentary pushbutton	\$221.00
660-T4	SPDT Maintained toggle	\$217.00

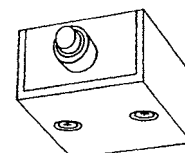

660

Recommended for concealed desk application.



442S SERIES CABINET LOCK

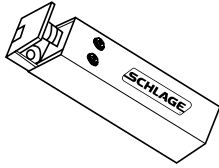

442S

SPECIFICATIONS

Overall Dimensions	3" L x 1" W x 1" D
Current Draw	0.50A @ 12 VDC; 0.25A @ 24 VDC (field selectable)

1. SELECT MODEL			
Model number	Description		Price
442S	Lock with strike - Black Lexan finish	Fail Secure	\$409.00

PB405/PB405S POWERBOLTS

Standard features

- Magnetic door status monitor
- Magnetic relocking switch



PB405/PB405S

SPECIFICATIONS

Bolt size 405/405S	.61" diameter x .67" throw
PB405 overall size	7.87" x 1.26" x 1.57", 90° locking
PB405S overall size	7.87" x 1.26" x 1.57"
Current draw	0.9A @ 12 VDC; 0.45A @ 24 VDC 12/24 VDC dual voltage, field selectable

1. SELECT MODEL		
Model number	Description	Price
PB405	Fail Safe, rectangular front	\$846.00
PB405S	Fail Secure, rectangular front	\$1,050.00
PB405-RFK	Retro fit kit	\$95.00

Fail Secure Lock – Requires power to unlock

Fail Safe Lock – Requires power to lock

Note: Electromechanical PowerBolts not recommended where life safety may be compromised, or where panic bar hardware is the only means of egress.

Mortise mount electric bolts furnished in Satin Aluminum finish.



Contents

Merchandising aids	291
Agency listings.....	292
Door and frame handing chart.....	294
System design guide	295
Master key system summary	296
Wiring diagrams.....	303
United States Wiring diagram request form.....	304
Canada Electrical drawing request form.....	305
BAA/ARRA Cover letter	306

MERCHANDISING AIDS

SCHLAGE ELECTRONICS WHITE WOOD MOUNTS									
47284859	47284860	47284861	47284862	47284867	47284868	47284869	47284870	47284871	47286238

DISPLAY MOUNTS							
Part number	Description	Dimension (inches)					
		Backset	Bore	Faceplate width	Total height	Width at base	Price
47284859	AD Mortise mount	2-3/4"	2-1/8"	1-1/4"	19-7/8"	8"	\$231.00
47284860	LE Mount	2-3/4"	1"	1-1/4"	19-7/8"	8"	\$231.00
47284861	CO Mortise mount	2-3/4"	2-1/8"	1-1/4"	19-7/8"	8"	\$231.00
47284862	4" Interconnect mount	2-3/8"	2-1/8"	1"	19-7/8"	8"	\$227.00
47284867	5.5" Interconnect mount	2-3/8"	2-1/8"	1"	19-7/8"	8"	\$227.00
47284868	CO Cylindrical mount	2-3/4"	2-1/8"	1-1/8"	19-7/8"	8"	\$231.00
47284869	AD Cylindrical mount	2-3/4"	2-1/8"	1-1/8"	19-7/8"	8"	\$231.00
47284870	NDE Mount	2-3/4"	2-1/8"	1-1/8"	19-7/8"	8"	\$231.00
47284871	Deadbolt, knob, and keypad mount	2-3/8"	2-1/8"	1"	19-7/8"	8"	\$227.00
44-115	Clear plastic mount ring	-	-	-	-	-	\$61.00
47286238	Mount carton carrying strap	-	-	-	-	-	\$29.00

Note: Price does not include lock.



Product	Listing	Standard	Agency
M420/M420P	Builders Hardware - Aux. Locks	UL 10C/UL 1034/UL 294	UL/cUL CSFM
M450/M450P	Builders Hardware - Aux. Locks	UL 10C/UL 1034/UL 294	UL/cUL CSFM
M490/M490P	Builders Hardware - Aux. Locks	UL 10C/UL 1034/UL 294	UL/cUL CSFM
M490DE	Builders Hardware - Aux. Locks	UL10C UL294 Special Locking Arrangement including BOCA	UL/cUL CSFM
M390RFK	Builders Hardware - Aux. Locks	UL 10C UL/cUL	UL/cUL CSFM
490G	Builders Hardware - Aux. Locks (outdoor rated)	-	-
320 Series (M suffix)	Builders Hardware - Aux. Locks	UL10C	UL/cUL CSFM
GF3000 (surface mount)	Builders Hardware - Aux. Locks	UL10C	UL /cUL
GF3000 (mortise mount)	Builders Hardware - Aux. Locks	UL10C	UL/cUL CSFM
PS902	Power Supply	UL294	UL/cUL FCC Part 15 and Rotts Compliant
PS904	Power Supply	UL294	UL/cUL FCC Part 15 and Rotts Compliant
PS906	Power Supply	UL294	UL/cUL FCC Part 15 and Rotts Compliant
900-2RS	Power Supply Option Board	UL294	UL/cUL
900-4R/900-4RL	Power Supply Option Board	UL294	UL/cUL
900-8P/900-8F	Power Supply Option Board	UL294	UL/cUL
900-FA/900-BB	Power Supply Option Board	UL294	UL/cUL
672 Series All models including BRG	Access Control System Units Burglary Resistant Electric Locking Mechanism Accessory	UL294 UL1034	UL UL
692 Series All models including BRG	Access Control Systems Units Burglary Resistant Electronic Locking Mechanism Accessory	UL294 UL1034	UL UL
7764 switch	Connectors and Switches Misc Fire Door Accessories	UL634 UL10B	UL - multiple listing UL - multiple listing
7766 switch	Connectors and Switches	UL634	UL - multiple listing
8200 Series	Access Control Units	UL294	UL
SCAN-II-W SCAN-II-B	Access Control System Units	UL294	UL - multiple listing

Listed electromagnetic locks

A156.23-2010 ANSI Type Numbers Licensee's Catalog

Designations

ANSI Function Number	1500 lbf Rating	1000 lbf Rating	500 lbf Rating
E18501	M490, M490P, M390RFX	M450, M450P, 70	M420, 420P, 40
E18511	M492, M492P	M452, M452P, 72	M422, M422P
E18531	M490-TJ, M490P-TJ	M450-TJ, M450P-TJ, 70-TJ	M420-TJ, M420P-TJ, 40-TJ
E18541	M490-HDB, M490P-HDB	M450-HDB, M450P-HDB, 70-HDB	M420-HDB, M420P-HDB, 40-HDB
E08501	M490G1		
E08531	M490G1		
E08561	GF3000, GF3000TJ		
E08571	280		
E08581	GF3000, 280		
E08591	GF3000, 280		
E08601	GF3000BRD		

1. Outdoor rated lock.
All of the above available in 12VDC or 24VDC.

Certified finishes

FINISH TYPE	LICENSEE'S CATALOG DESIGNATIONS
Clear Anodized Aluminum	628
Satin Black, Anodized	335

AD Series and CO Series Electronic locks

Product	Standard
AD Series and CO Series	UL294 UL10C BHMA/ANSI 156.25 Grade 1 Operation and Security <ul style="list-style-type: none"> ▪ A156.2 ▪ A156.3 ▪ A156.12 ▪ A156.13 ▪ NFPA 101 – Ch 7 ▪ NFPA 80 – Ch 6 and 7 ▪ IBC – Ch 10 ADA – Ch 4.13 FCC Part 15 Industry Canada (IC) RSS-210 Florida Building Code RoHS

Door and frame handing chart

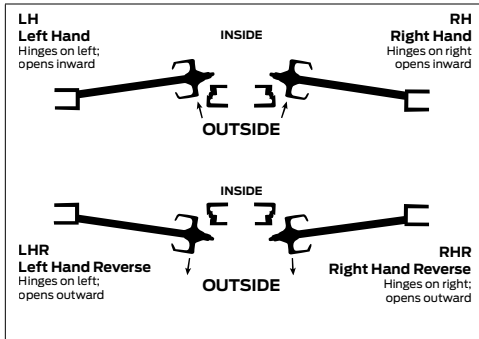

Door handing from reader side

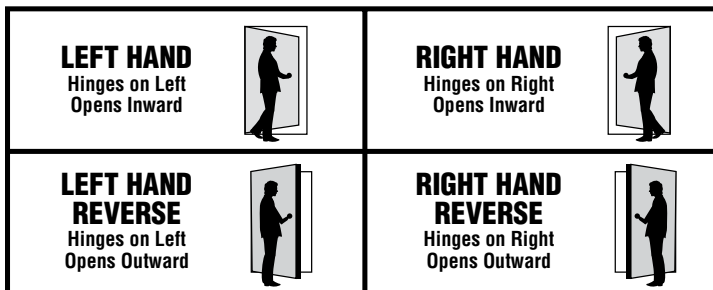

ARCHITECTURAL FINISHES CHART			
Finish description	Finish No.	BHMA No.	Government
Bright Brass	605 or 666	605E	US3
Bright Chrome	625 or 672	625E	US26
Oil-Rubbed Bronze, Anodized	690 or 313	690	US20A
Oil-Rubbed Bronze	613 or 710	613E	US10B
Satin Aluminum, Clear Anodized	628	628	US28
Satin Black, Anodized	711 or 335	711	US19
Satin Brass	606	606E	US4
Satin Bronze	612 or 668	612E	US10
Satin Chrome	626	626E	US26D
Satin Stainless Steel	630	630	US32D
Oil-Rubbed Bronze, Powder Paint	SP313	-	-
Satin Black, Powder Paint	SP335	-	-

Note: To preserve finishes, wipe clean with a soft cloth. Commercial cleaners may damage finish.

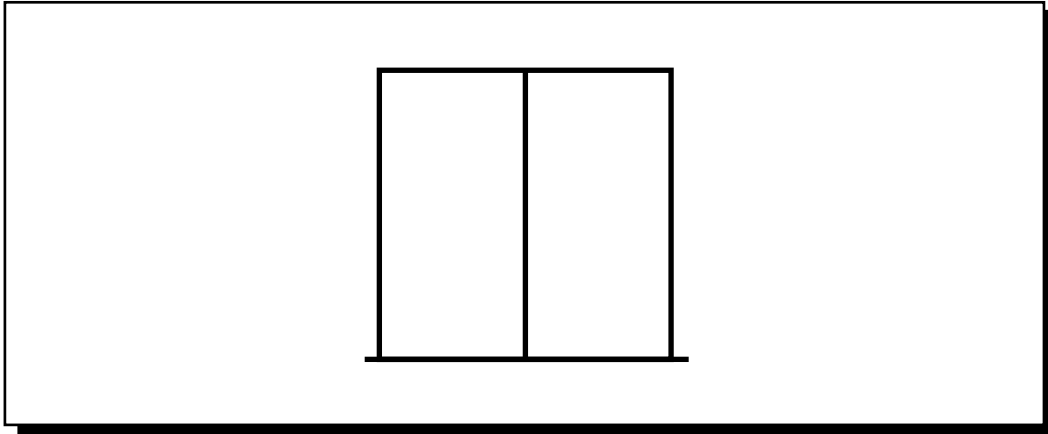

DESCRIPTION OF OPERATION _____

ELECTRIC LOCK

TYPE: VOLTAGE: CURRENT DRAW

OPTIONS

LOCK STATUS SW: DOOR STATUS SW

POWER SUPPLY

MODEL: VOLTAGE: CURRENT CAPACITY

OPTIONS

FIRE SYSTEM TIE-IN: STANDBY BATTERIES

CONTROL-ACCESS

TYPE:

CONTROL-EGRESS

TYPE:

MONITORING REQUIRED – DESCRIBE: _____

INTERLOCK REQUIRED – DESCRIBE: _____



MASTER KEY SYSTEM SUMMARY

This form must be attached to the **Master Key Order form and P.O.**
Please provide as complete and accurate as possible so we can provide what you need for your Key System.

Job Name

Address
City / State

Country

Account No.

P.O.#

For detailed instructions on how to complete this form please refer to pages 4 & 5

System Overview

New

Existing (provide info below)

Attached Dealer Specified Combinations

Registry # _____

Structure or
Factory Order # _____

1. Select System

Schlage

Classic

Classic Primus *

Everest®

B (Small Format IC, Restricted *)

C (Open)

Primus® *

D (Restricted *)

Primus® *

Everest 29™

R (Small Format IC, Restricted *)

S (Open)

Primus® *

T (Restricted *)

Primus® *

Falcon

Standard

Schlage C

Restricted *

Interchangeable Core A2

Interchangeable Core A4

Everest 29 key sections are backwards compatible to Everest keyways and have the following relationships:

R family sections > B family keyways

S family sections > C family keyways

T family sections > D family keyways

Type

5-pin 6-pin 7-pin

See compatibility chart on page 5

Keyway _____

Specified **: _____

** = The Commercial Master Key Department makes the final decision in the selection of key sections

Construction Keyed Yes No

Full Size Construction Cores ICA ICB ICC
(Schlage Only)

Small Format Construction Cores Brown Green

Construction Keyed Type

Falcon CK (BOK) Lost Ball

Schlage CK (Split) RCK (5-Pin C only)

2. Select Keys & Key Stamping

Change Keys

No. Of Keys per Symbol _____

No. Of Keys per Cylinder _____

Type

Standard Bow

Standard Bow
(Unembossed)

Access Bow

Large Bow

Key Stamp Details

Keyset Symbol

Do Not Duplicate
(DND)

With Custom Die
(Specify) _____

Non-standard Code (Specify) _____

Change Key Packaging and Shipping Instructions

Pack Keys Independently (PKI) of Lock or Cylinder ***

*** = *Furnished standard at no charge with
Split-Key construction keying*

Yes No

If PKI, ship change keys to:

Dealer

Other _____

See Primus Facesheet

3. Select Cylinder Stamping

Cylinder Stamp Details

With Industry Standard Key Symbol

Non-Standard Code (Specify)

Cylinder Stamping Location

Plug Face (N/A in Primus) - VKC

Concealed (N/A in Falcon STD) - CKC

4. Select Key Quantities

Level	Qty. Per	Master Key Symbol (s)	Total Quantity
GGM _____	_____	_____	_____
GM _____	_____	_____	_____
MK or RMK _____	_____	_____	_____
Control _____	_____	_____	_____
Emergency _____	_____	_____	_____
Others _____	_____	_____	_____

Ship Master Keys To:

Dealer
 See Primus Facesheet
 Other _____

Special Function	Qty. Per		Qty. Per
RCK (Lost Ball) ****	_____	Full Size Construction Core Keys (Schlage Only)	_____
CK (Split Key) ****	_____	Full Size Construction Core Control Keys (Schlage Only)	_____
Extractor Tools ****	_____	Small Format Construction Core Keys	_____
		Small Format Construction Core Control Keys	_____

**** = Use with Construction Keying

5. Master Key Future Expansion

List Future MK Symbols	Approx. # of Change Key Symbols Under Each Future MK
Example: MK..... <input checked="" type="checkbox"/>	BJ, BK _____ 40 each _____
GGM <input type="checkbox"/>	_____
GM <input type="checkbox"/>	_____
MK <input type="checkbox"/>	_____
MK <input type="checkbox"/>	_____
MK <input type="checkbox"/>	_____
MK <input type="checkbox"/>	_____
Others <input type="checkbox"/>	_____

6. Operating Instructions

(Unless otherwise specified, all hierarchical master keys will operate cross-keyed cylinders)

Cross Keyed Cylinder	is operated by these change keys	Cross Keyed Cylinder	is operated by these change keys
X _____	_____	X _____	_____
X _____	_____	X _____	_____
X _____	_____	X _____	_____
X _____	_____	X _____	_____

7. Instructions and Compatibility

General Information

If you do not know the registry number (R#), structure number or the original factory order number for an existing system, contact Customer Service prior to placing the order:

USA:	CANADA:
Tel. 1-877-671-7011	Tel. 1-800-900-4734
Fax 1-800-452-0663	Fax 1-800-209-4734

- Only one structure may be ordered on the same purchase order
- Classic refers to Obverse, Numbered (Paracentric), Quad, and Reverse key section families
- Classic Primus refers to Primus Obverse and Primus Quad key section families

Section 1: Select System

Full Size Construction Cores

- Schlage only

Small Format Construction Cores

- 7-pin only for Schlage
- 6- and 7-pin for Falcon

CK (Split)

- 6-pin for Schlage and Falcon
- Split key construction keying is not available for Classic Primus or Everest 29 Primus

RCK (Lost Ball)

- 5-pin (C keyway) only for Schlage
- 5-, 6-, and 7-pin for Falcon

System Selection

- Refer to the compatibility chart

Section 2: Select Keys and Key Stamping

Stamp Details

- Unless otherwise specified, industry standard key symbols are stamped on Everest 29™ and Primus® keys
- For custom die, attach RFQ approval for Schlage

Section 3: Select Cylinder Stamping

Type

- For cylinder type refer to the compatibility chart

Keyway (specify)

- Schlage Commercial's default key section for new Master Key Systems is Everest™ S145

Section 4: Key Quantities

Level

- Unless otherwise specified, the control key has the same cut as the highest-level key in the system (Except SFIC systems)

Special Function

- Construction keys are not furnished unless specified

Change Keys

- Unless otherwise specified 2 change keys are furnished per lock or cylinder

Section 5: Master Key Future Expansion

- Do not use the letters “I”, “O”, “CK”, “KA, or “KD” for any master key symbols

Section 6: Operating Instructions

- Cross keying reduces the security and expansion of key systems
- Unless otherwise specified, all hierarchical master keys will operate cross-keyed cylinders

Compatibility Chart

	5 Pin	6 Pin	7 Pin	Split Key	Block O-Key	Lost Ball	Temp Core	A2	A4	0.025	0.018
Schlage											
Classic	X	X		X		X	X				
Everest 29 S		X		X			X				
Everest 29 T		X		X			X				
Everest 29 R			X				X	X			
Classic Primus (XP)		X					X				
Everest 29 Primus (XP)		X					X				
Falcon											
Open	X	X	X		X	X					X
Restricted		X	X		X	X				X	
Schlage C		X		X							
SFIC Open		X	X				X	X	X		
SFIC Restricted		X	X				X	X	X		

QUOTE #		PRICE BOOK #	
SHIPPING INSTRUCTIONS			
REQUESTED SHIPDATE		MARK CARTONS:	
ORDER WRITTEN BY		CUSTOMER NAME AND ADDRESS:	
FOR FURTHER INFORMATION, CONTACT:			
Name:		SHIP TO:	
Phone:		ACCOUNT NO.	
Fax:		P.O. NO.	
		DATE	

Non-Master Keyed ORDER



LINE ITEM	QTY	PRODUCT	OUTSIDE		INSIDE		HAND	LATCH	STRIKE	DR THK	EXT	DIM	ADDITIONAL DETAILS Use for Key Section and Biting Information, KA Groups, Primus® No., Locksmith ID No., etc.
			DES	FIN	DES	FIN							

FORMS & EXAMPLES • **Sample Letter of Authorization For All Restricted Key Products**



DISTRICT 10

End User Letterhead - REQUIRED

District 10 Schools
555 Main Street
End User City, State 55555
(555) 555-5555

May 1, 2003

← **Date - REQUIRED**

To: Schlage Dealer
100 East Avenue
Dealer City, State 11111



Dealer Name - RECOMMENDED

Include Registry Number & Facility Code (stamped on keys) for existing key systems

RE: District 10, Jones Elementary School

← **Facility Name - REQUIRED**

Please consider this authorization to ship product for the above-referenced project.

Jones Elementary School is to be keyed using a new Everest 29 T Restricted Key System. For security reasons, we would like to have all keys for this facility shipped to a location other than the job site. Master keyed products, however, can be shipped directly to the site. This letter authorizes Schlage to ship our restricted products to the following addresses:

Master Keyed Products, Construction Keys, Locks Less Cylinders, and Locks with Construction Cores
Attn: Building Project Manager
District 10 Schools
555 Main Street
End User City, State 55555

Master Keys, Change Keys, Control Keys, and Key Blanks
Attn: Locksmith
District 10 Lockshop
1201 Fifth Avenue
End User City, State 55555



Authorized Ship-To Addresses - REQUIRED

These two addresses above serve as our only authorized shipment addresses for all orders placed for our facility. We understand that this letter will be kept on file and referenced for our future orders and that a new letter is only required to add, remove, or change authorized shipping locations.

Sincerely,

End User Representative
Facilities Manager



End User Representative Signature - REQUIRED

United States
Letter may be mailed or faxed to Schlage
Schlage Restricted Order Processing
3899 Hancock Expressway
Colorado Springs, CO 80911

Canada
Letter may be mailed or faxed to Schlage
Allegion Canada Inc.
Attn: Master Key Department
1076 Lakeshore Rd E Mississauga, ON, L5E 1E4

A library of common wiring diagrams are available at no-charge for use in single and double door applications utilizing various configurations of Allegion door hardware products. These diagrams can be accessed through our Knowledge Center tool at <http://kc.allegion.com/>

Click on Common Wiring Diagrams located under the column Top Solutions.

CUSTOM WIRING DIAGRAMS

When common wiring diagrams do not meet the needs of the job requirements, Allegion offers a service to purchase custom wiring diagrams. All custom wiring diagrams include a point-to-point with theory of operation and a riser diagram. Custom wiring diagrams fall into two categories: Standard and Complex.

- **Standard drawings:** All Allegion products with a single opening and a basic theory of operation. These drawings are quoted on a per drawing basis.
- **Complex drawings:** Generic contacts, 3rd party components, complex relay logic, timer circuit logic, any other additional advanced logic. These drawings must be processed through a quote process to determine the total NET cost of the request.

How does the Custom Wiring Diagram Request Process work?

- Custom wiring diagrams can only be ordered by and shipped to current Allegion Channel Partners.
- For United States, Wiring Diagram Request Forms can be obtained by:
 - Sending an email request to Wiring.Diagram.Request@allegion.com
 - Using the form located on page 304
- For Canada, Wiring Diagram Request Forms can be obtained by:
 - Sending an email request to Canada.TechServices@allegion.com
 - Using the form located on page 305
- For United States, email the completed request form to Wiring.Diagram.Request@allegion.com. For Canada, please email the completed request form to Canada.TechServices@allegion.com.
- Be sure and include the following information to prevent delays to the request:
 - All supporting documentation for non-Allegion products
 - Hardware list with complete part numbers
 - Detailed theory of operation for all openings
- Upon receipt, the custom wiring coordinator will review and clarify the request as needed.
- Once all clarifications are resolved, a QUOTE#, NET pricing, and lead time will be assigned and communicated to the requester within one business day.
- Drawings that fall under a Standard type will be quoted a NET \$300.00 for each drawing.
- Drawings that fall under a Complex type will receive a NET quote depending on the time required to complete the drawings at an hourly rate of \$300.00/hour.
- A purchase order with the QUOTE# must be received for the wiring diagrams to be produced.
 - For United States, send the completed PO to Wiring.Diagram.Request@allegion.com
 - For Canada, send the completed PO to Canada.TechServices@allegion.com
- Lead time is generally 2-3 weeks from time PO is received, more complex requests will have longer lead times.
- Changes to the original request after a quote approval may incur additional charges and affect lead time.
- QUOTE# is valid for 90 days.
- Custom wiring diagrams, once completed, will be emailed to the requester.



United States Wiring Diagram Request Form

Must be a Schlage Electronics, LCN, or Von Duprin Dealer

UNITED STATES ELECTRICAL DRAWING REQUEST FORM

Date:	Project Name:
Dealer/Distributor:	
Account Number:	Dealer Contact Name:
Phone:	
Provide a Primary Technical Contact:	Phone:

Provide/Attach the Following:

- All supporting documentation for all non-Allegion products
- Included hardware list with complete part numbers
- Detailed Theory of Operation for all openings

Additional information that helps expedite the project:

Door Number:
Door Size:
Door Material:
Fire Rated Opening:
Single/Pair:
Double Egress:
Interior/Exterior:
Interlocked Opening:
Basic Floor Plan/Traffic Flow:

United States

Email completed form and supporting documentation to:
Wiring.Diagram.Request@allegion.com



Canada Wiring Diagram Request Form

CANADA ELECTRICAL DRAWING REQUEST FORM

Rep./Distributor Name:

Job Name:

Contact Name:

Phone:

Fax:

P.O.#

Date:

Select Drawing Type

Riser:

Point to Point:

Both:

Door Type:

Door Number:

Fire Rated Opening:

Double Egress:

Single:

Pair:

Specify all electrical hardware:

Quantity:

Power Supply:

Maglock/Elec. Strike:

Card Reader/Keypad:

Controller/Console:

Keyswitch:

Push Button:

Auto Operator:

Actuator:

Closer/Holder:

Exit Device:

Power Transfer:

Door Contact:

Other:

Specify daytime operation:

Push Side:

Pull Side:

Specify nighttime operation:

Push Side:

Pull Side:

Provide a sketch of the door opening if positioning of hardware is pertinent:

Canada

Email completed form and supporting documentation to:
Canada.TechServices@allegion.com



BAA Order Transmittal Cover Letter



Buy America Act and American Recovery and Reinvestment Act (BAA/ARRA)

*Note that orders requiring BAA compliant products MUST include this cover letter to
be properly identified.*



* Note: BAA does not apply to Canada.

this page intentionally blank

About Allegion

Allegion (NYSE: ALLE) is a global pioneer in seamless access. We keep people and their assets safe, wherever they are, bringing together simple solutions, convenient access and advanced technology.

For more, visit www.allegion.com

KRYPTONITE ■ LCN ■  ■ STEELCRAFT ■ VON DUPRIN