

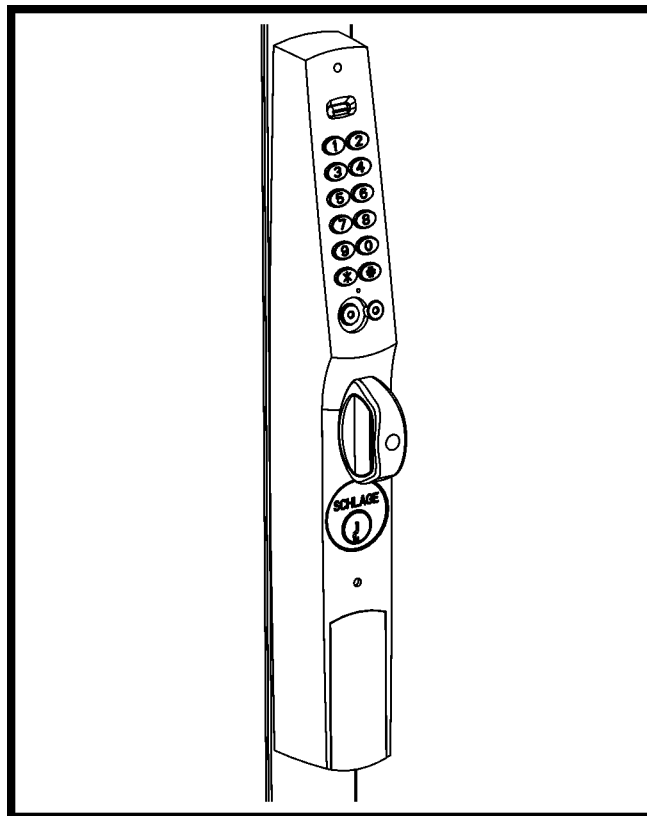

# KING COBRA/KING COBRA-2 NARROW STILE SERIES

## INSTALLATION MANUAL

KC9359/KC9359-2



**Keypad Programmable and  
SNAP Compatible Trim For  
Surface Mounted Vertical Rod  
Exit Devices on Aluminum Doors.**

# KC9359/KC9359-2 INSTALLATION INSTRUCTIONS

## Contents of the Box

### Confirming the Box Contents

The following items should be included in the box. If any of these items are missing, please contact the Technical Support Department for assistance.

#### 4 "AAA" Batteries Included

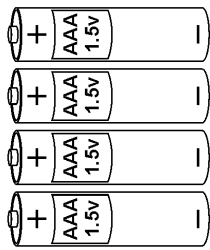

#### Optional Parts

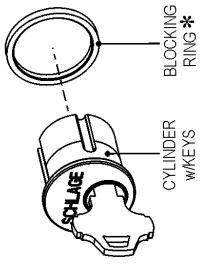

#### DOCUMENTS INCLUDED IN BOX:

- Installation Manual
- Programming Instructions

1 Full Size, Outside Door Template

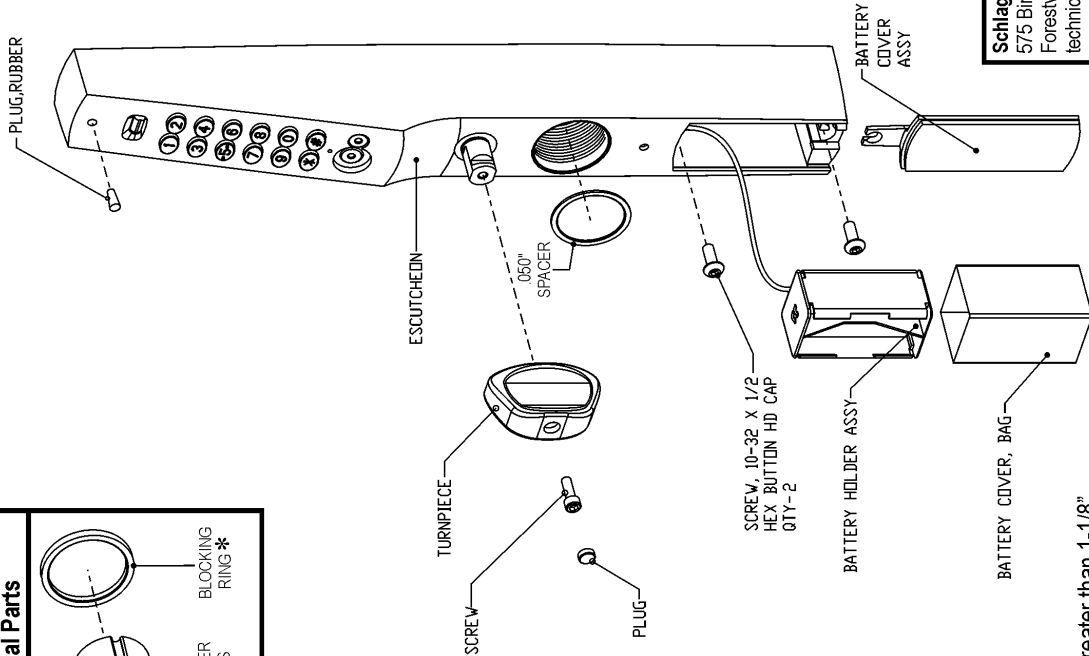
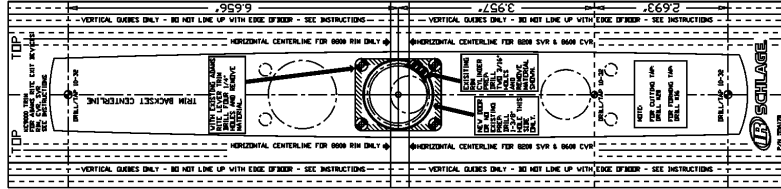

\* Blocking Ring required for cylinder length greater than 1-1/8"  
(Blocking Ring thickness = cylinder length minus 1-1/8")

Schlage Lock Company

575 Birch Street  
 Forestville, CT 06010  
 technical support: 866-322-1237  
 fax: 866-322-1233  
 web: <http://www.itsupport.net>



# KC9359/KC9359-2 INSTALLATION INSTRUCTIONS

## *Introduction / Tools and Materials Needed / Contact Info*

---

### **Introduction:**

The KC9359/KC9359-2 is designed to replace existing exterior cylinders or trim on Adams Rite® 8200 surface vertical rod exit devices mounted on aluminum doors. The trim will allow access by allowing the trim to unlock the exit device when an access code or iButton is entered and the turnpiece is turned counter-clockwise. Mechanical key override is standard. The trim is compatible with the dogging features available with the Adams Rite® exit devices.

**The KC9359/KC9359-2 is compatible with Adams Rite® surface mounted vertical rod exit devices on aluminum doors.**

### **Tools and Materials Needed:**

1. Flat head screwdriver w/straight, 1/8" wide blade
2. Small Philips head screwdriver
3. 1/16" Allen wrench
4. Long nose needle-nose pliers
5. Center punch
6. Hammer
7. Power drill
8. 19/32" drill bit
9. 1/4" drill bit
10. Jig saw w/blade
11. Drill & Tap for 10-32 threads

### **Contact Information:**

**Schlage Lock Company**  
575 Birch Street  
Forestville, CT 06010  
technical support: 866-322-1237  
fax: 866-322-1233  
web: <http://www.irsupport.net>

# KC9359/KC9359-2 INSTALLATION INSTRUCTIONS

## Door Preparation

### Door Conditions:

Installation may require the use of a cover plate (a) to cover the holes left in the door. If an existing pull (b) must be removed, Ives offers a compatible pull.

- >Schlage Cover Plate P/N: KC9000-KRP
- >Ives Pull P/N: 8190-18-xxx (xxx = finish)

Backset is determined by the Adams Rite® lock.

Horizontal centerline for Adams Rite® 8200 SVR & 8600 CVR

For factory prepped doors, use dimensions shown. Dimensions are referenced from center of 1-1/4" cylinder hole. Backset is determined by the Adams Rite® lock.

When installing new Adams Rite® locks, do not install outside cylinder (because this trim replaces it).

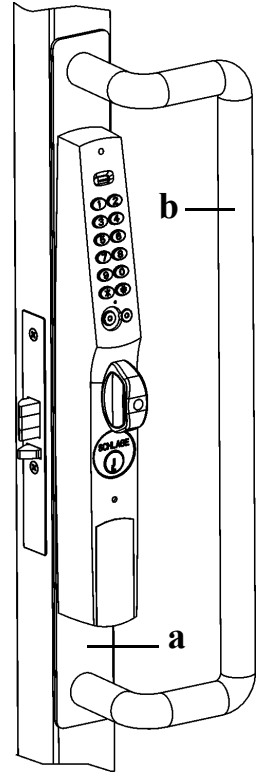
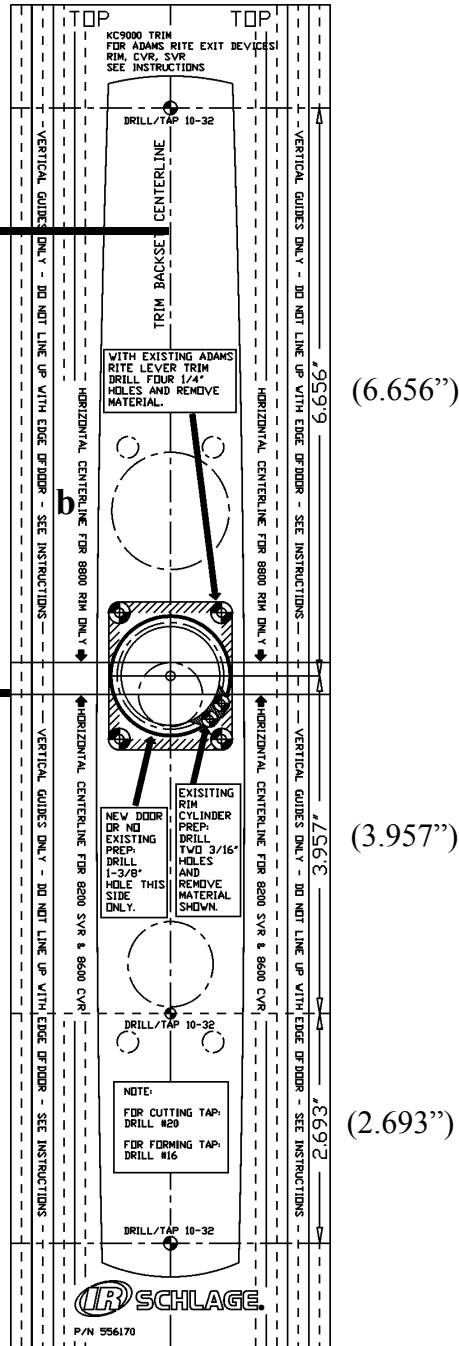

# KC9359/KC9359-2 INSTALLATION INSTRUCTIONS

## Cams, Cores, Cylinders and Blocking Rings

### Cams For Mechanical Override Cylinder:

The KC9000 trim requires the use of a clover leaf cam (a). This is a list of compatible Schlage parts. For other manufacturers, consult cross-reference charts.

- > Cam for Standard Mortise cylinder: Schlage Everest: L583-153  
Schlage Classic: L583-254
- > Cam for Interchangeable Core: Schlage IC Cam: L583-255

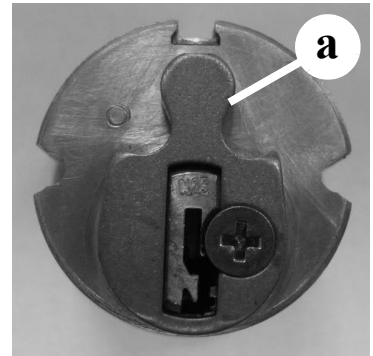

### IC Cores:

- > Small Format IC core w/ cam: Schlage: 80-108-<FINISH>  
**NOTE: This core requires the use of 1/4" blocking ring:**  
Schlage: 36-079-025-<FINISH>



- > Full Size IC core w/ cam: Schlage: 30-016-<FINISH>  
**NOTE: This core requires the use of 3/8" blocking ring:**  
Schlage: 36-079-037-<FINISH>



### Cylinders / Blocking Rings:

The KC9000 can use a 1-1/8" mortise cylinder without the use of a blocking ring. For cylinders longer than 1-1/8" a blocking ring is required. The blocking ring thickness is equal to the cylinder length, minus 1-1/8". For example, if you use a 1-1/2" cylinder you need a 3/8" blocking ring. Compression rings can be ordered from a Schlage distributor:

	Thickness:	Schlage Part Number:
No compression ring:	1/8"	36-079-012-<FINISH>
	1/4"	36-079-025-<FINISH>
	3/8"	36-079-037-<FINISH>
	1/2"	36-079-050-<FINISH>



# KC9359/KC9359-2 INSTALLATION INSTRUCTIONS

## Installing the KC9359/KC9359-2

### Installing the KC9359/KC9359-2

If your trim has a key cylinder already installed, skip to **Prep for Exit Only or New Installation: on page 12**. Otherwise, continue with **Loosen the Baseplate Screws: on this page**.

#### 1) Loosen the Baseplate Screws:

**IMPORTANT:** Do not remove any of the screws in the following step or it will be difficult to reinstall them.

- Using a small Philips head screwdriver, **loosen** screws **a** & **b** in baseplate, around key cylinder hole, one turn.

**NOTE:** Screws **a**, **b**, **c** & **d** are set at the factory.

Screws **a** & **b** are tightened and screws **c** & **d** are left loose.

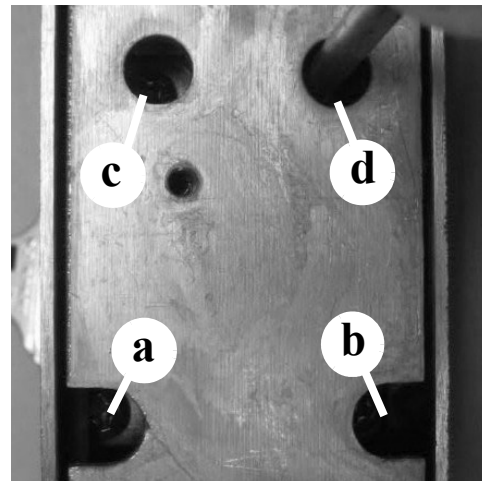

#### 2) A Key Cylinder That Is At Least 1-1/8" Long Must Be Installed:

- > The key cylinder that you install must be 1-1/8" long or longer.
- >>>> **Do not attempt to install a key cylinder that is shorter than 1-1/8"**
- > The two photos below illustrate the difference between a 1" and a 1-1/8" key cylinder.

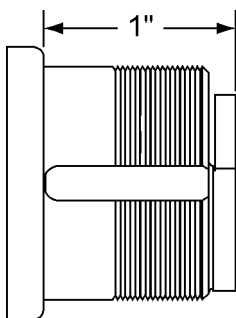

1" long key cylinder.

**DO NOT ATTEMPT TO INSTALL A 1" LONG KEY CYLINDER.**

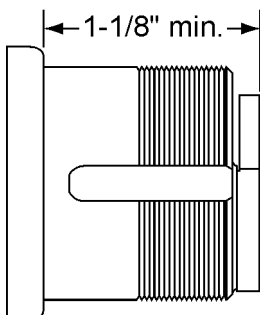

1-1/8" long key cylinder

**ONLY INSTALL A KEY CYLINDER THAT IS AT LEAST 1-1/8" LONG.**

# KC9359/KC9359-2 INSTALLATION INSTRUCTIONS

## Installing the KC9359/KC9359-2

### 3) Make Room for Key Cylinder:

Due to the diameter of the key cylinder, it is necessary to have dead latch (a) placed out of the way when installing the key cylinder. Therefore...

- Using your finger or a pair of needle-nose pliers, push dead latch towards the top end of trim as indicated by arrow in photo.

**NOTE:** As indicated by arrow in photo, you'll notice that when you push the dead latch forward, it will swing a little bit in a counterclockwise direction.

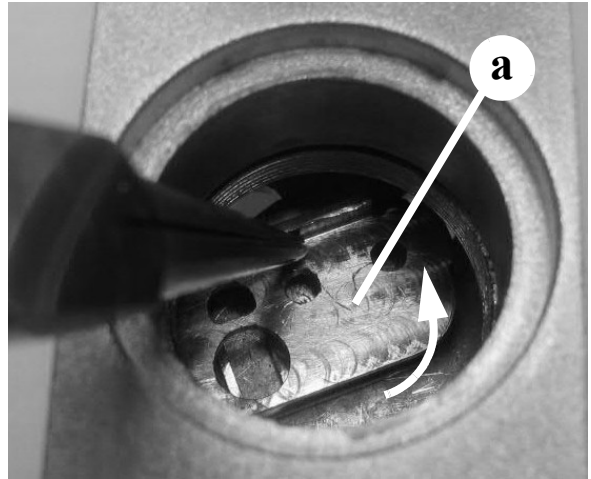

### 4) Hold Dead Latch in Place:

To insure that dead latch is placed far enough out of the way to allow key cylinder to be threaded in properly:

- Insert a finger into key cylinder hole and hold dead latch firmly in place.
- Carefully turn the trim over while keeping the dead latch in position.



### 5) Verify Placement of Dead Latch:

Two holes on dead latch (a) should be showing within the two holes (b) in baseplate.

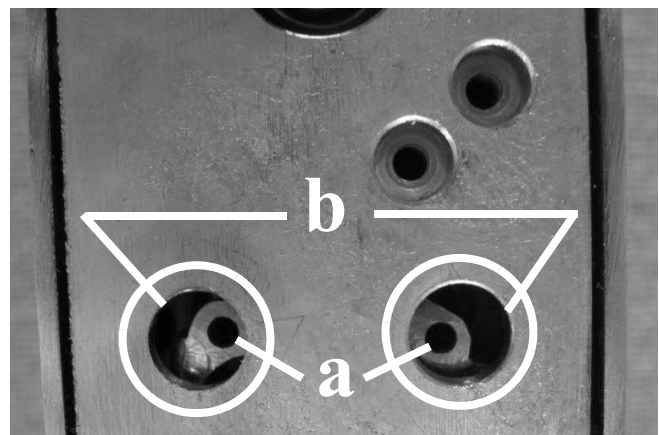

# KC9359/KC9359-2 INSTALLATION INSTRUCTIONS

## Installing the KC9359/KC9359-2

### 6) Install the Key Cylinder:

- Install .050" cylinder washer.

**IMPORTANT:** A .050" cylinder washer must be used **IN ALL CASES**, regardless of the key cylinder length.

- If you are installing a cylinder that is longer than 1-1/8", you must also install a blocking ring (see **Table 1: Blocking Rings**, on page 8).

A simple formula for determining blocking ring thickness is:

**Blocking ring thickness = length of cylinder minus 1-1/8"**

- If not already done, install cam onto cylinder. Cam must be clover leaf design (see **Table 2: Recommended Cams**, on page 8).
- Tilt top of trim down at a sharp angle.
- Screw in key cylinder until it stops. Use mechanical key as a handle for turning if necessary.



**Table 1: Blocking Rings**

Key Cylinder Length	Blocking Ring (Schlage P/N; XXX = finish)
• 1-1/4"	1/8" (36-079-012-XXX)
• 1-3/8"	1/4" (36-079-025-XXX)
• 1-1/2"	3/8" (36-079-037-XXX)
• 1-5/8"	1/2" (36-079-050-XXX)

**Table 2: Recommended Cams**

Cylinder/Core	Schlage Type	Part Number
• Standard Mortise Cyl	Everest	L583-153
• Standard Mortise Cyl	Classic	L583-254
• Interchangeable Core	IC Cam	L583-255

### 7) Align Key Cylinder:

- After screwing it all the way in, back off on key cylinder (no more than one turn) until key is at the bottom. If key cylinder has a logo (a), logo should be at the top of key cylinder.

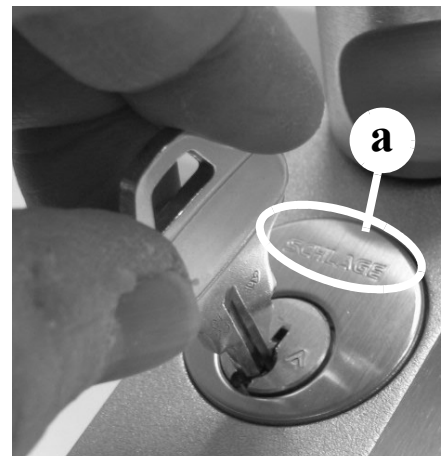



# KC9359/KC9359-2 INSTALLATION INSTRUCTIONS

## Installing the KC9359/KC9359-2

### 8) Alignment of Interchangeable Cores:

- If an IC Core is used, center the interface toward the bottom.



### 9) Tighten the Four Screws in the Baseplate:

- Tighten the four baseplate screws in the following order:
  - > Tighten **a** and **b** until snug.
  - > Tighten **c** and **d** until snug.
  - > Fully tighten **a** and **b**.
  - > Fully tighten **c** and **d**.
  - > Check all four screws to make sure that all four are completely tight.

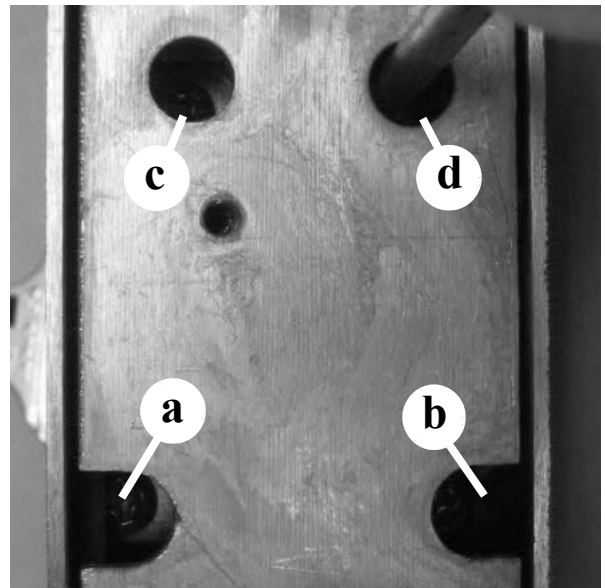

### 10) The Dead Latch's "Critical Edge:"

- For clarity purposes only, photo on the right is a view of deadlatch with escutcheon removed.
- Edge (**a**) is referred to as the dead latch's "critical edge."

**IMPORTANT:** In the next step, the "critical edge" on deadlatch will have to be lined up with hole (**b**) in baseplate. See Position the Dead Latch's Set Screw Hole: on page 10

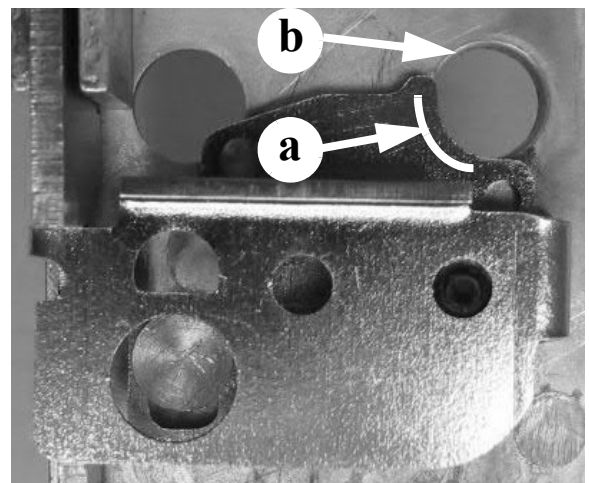

# KC9359/KC9359-2 INSTALLATION INSTRUCTIONS

## Installing the KC9359/KC9359-2

### 11) Position the Dead Latch's Set Screw Hole:

- Tilt the trim until you see the “critical edge” align with the larger hole in the baseplate as shown in photo on right. Look closely at edge of dead latch’s “critical edge” (a) when doing this.

**IMPORTANT:** *When the dead latch’s “critical edge” is correctly aligned, the dead latch’s set screw hole will likewise be correctly aligned.*

Photos A, B and C below illustrate examples of an incorrectly aligned critical edge. Photo D is an example of a correctly aligned critical edge.

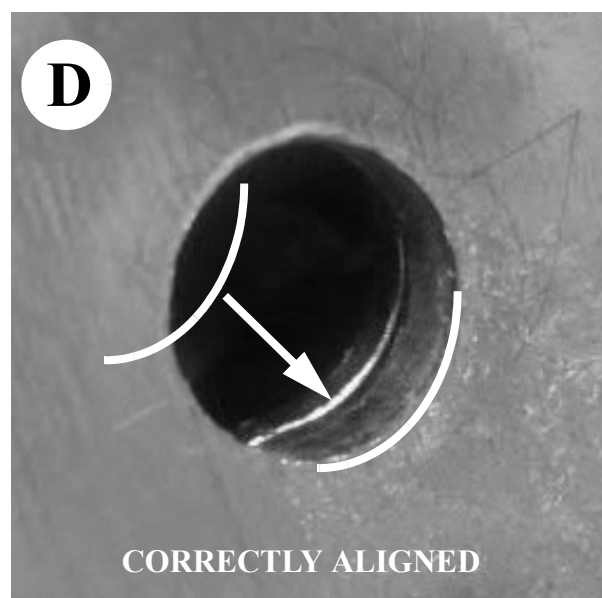
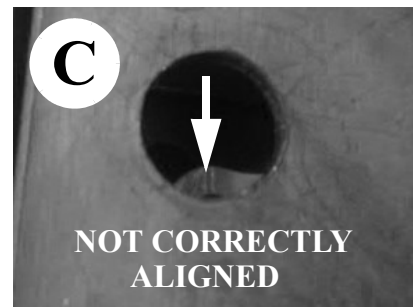
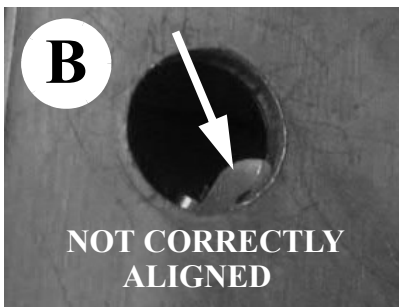
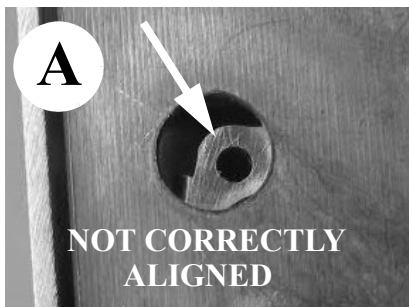
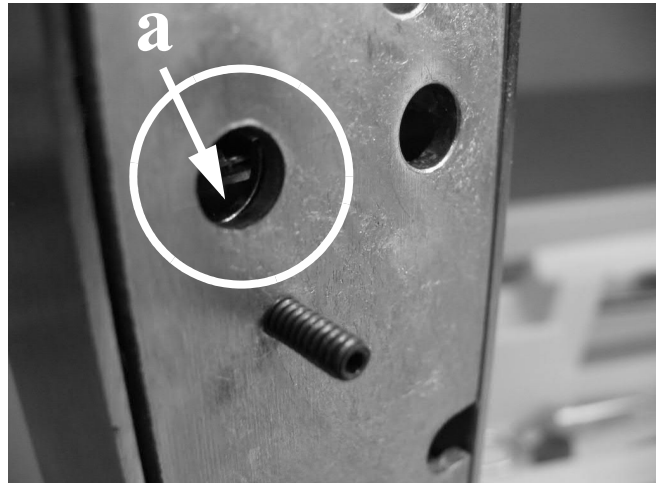

# KC9359/KC9359-2 INSTALLATION INSTRUCTIONS

## Installing the KC9359/KC9359-2

### 12) Partially Tighten the Set Screw:

- Using a 1/16" Allen wrench, partially turn in the set screw until outer end of set screw is about flush with surface of baseplate.



### 13) Fully Tighten the Set Screw:

- Finish turning in the set screw until it hits the stop.

**IMPORTANT:** At this time, outer end of set screw should be a little bit below the surface of the baseplate, as shown in photo A. If you have turned in set screw as far as it will go and it is protruding beyond the surface of baseplate, as shown in photo B, the most probable cause is that dead latch was not positioned properly (see Position the Dead Latch's Set Screw Hole: on page 10).

If you have turned the set screw in as far as it will go and it is protruding from the surface of the baseplate, do the following:

- Turn set screw back out so that about 1/4" is protruding from surface of baseplate.
- Reposition critical edge on dead latch according to the instructions on page 10).
- Turn set screw in until it **just hits the stop**.

**IMPORTANT:** Do not overtighten set screw because the baseplate may start to bow outward resulting in a gap between trim and door when trim is mounted.

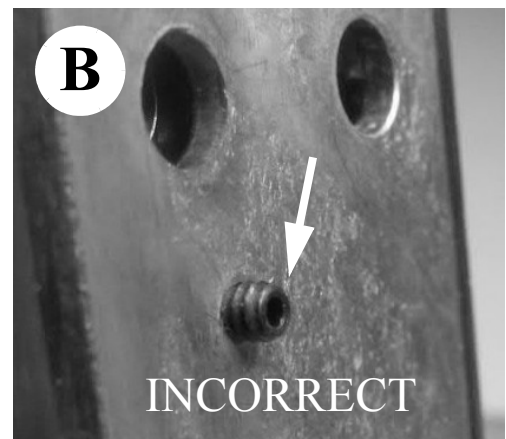
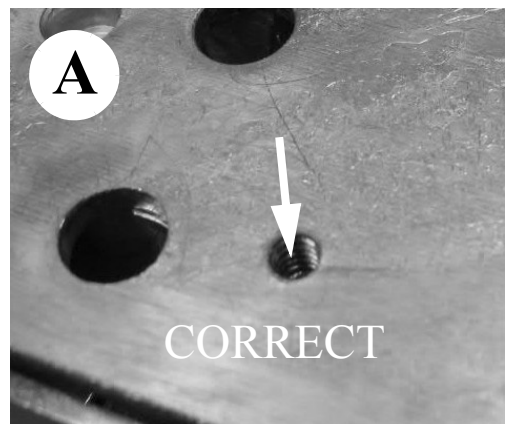

# KC9359/KC9359-2 INSTALLATION INSTRUCTIONS

## Installing the KC9359/KC9359-2

### 14) Prep for Exit Only or New Installation:

- Prep door for device according to Adams Rite® instructions.
- Do additional prep for rim cylinder using a 1-3/8" diameter hole instead of a 1-3/16" diameter.

**NOTE: This simplifies door prep. See Adams Rite® instructions.**

- Place transparent self-adhesive template on door
  - > Center template's circle on door's 1-3/8" hole.
  - > Align template's vertical guide lines parallel to door's edge.

**NOTE: Template can be lifted and repositioned as often as required.**

- Drill and tap the three #10-32 holes.

**NOTE: If optional blind nuts are used, see blind nut installation instructions for hole size and mounting method.**

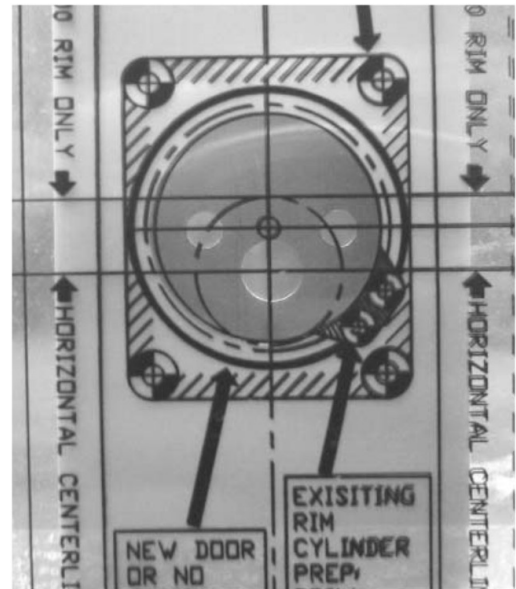

### 15) Prep with Existing Rim Cylinder:

- Remove exit device



- Remove rim cylinder.
  - > Refer to Adams Rite® instructions for more info.



# KC9359/KC9359-2 INSTALLATION INSTRUCTIONS

## Installing the KC9359/KC9359-2

### 16) Prep with Existing Rim Cylinder (continued):

- Place transparent self-adhesive template on door.
  - > Align template's vertical guide lines parallel to edge of door.
  - > Center 1-5/16" circle on existing cylinder hole.

**NOTE:** The lines on template's edges are for vertical guidance only. Do not line them up with edge of door.

**NOTE:** Template can be lifted and repositioned as often as required.

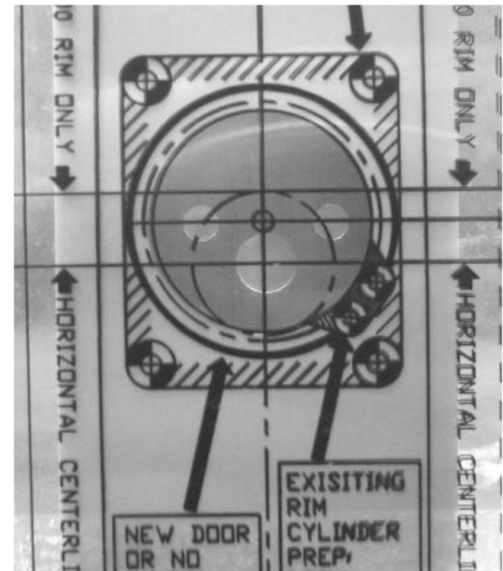

- Drill and tap three #10-32 holes.

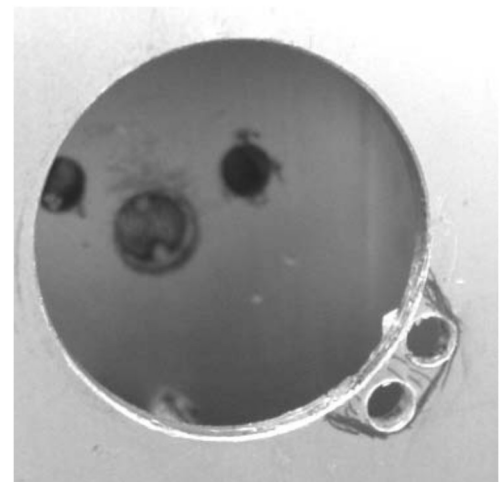

- Drill two 3/16" dia. holes
- Remove material.

**NOTE:** If optional blind nuts are used, see blind nut installation instructions for hole size and mounting method.

- Reinstall exit device.
  - > Refer to Adams Rite® instructions for more info.

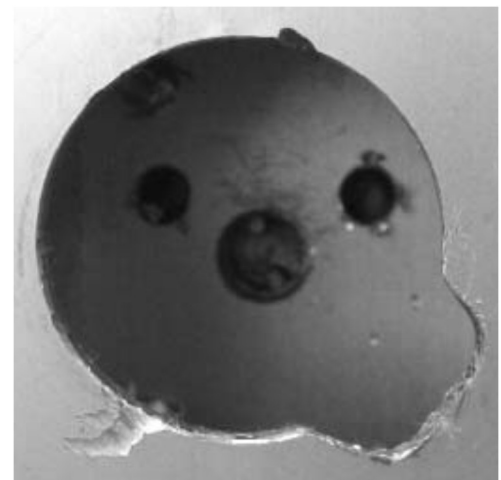

# KC9359/KC9359-2 INSTALLATION INSTRUCTIONS

## Installing the KC9359/KC9359-2

### 17) Prep with Existing Adams Rite® Lever Trim:

- Remove trim.
  - > Refer to Adams Rite® instructions for more info.
- Place transparent self-adhesive template on door.
  - > Align template's vertical guide lines parallel to edge of door.
  - > Center 1-5/16" circle on existing cylinder hole.

**NOTE: The lines on template's edges are for vertical guidance only. Do not line them up with edge of door.**

**NOTE: Template can be lifted and repositioned as often as required.**

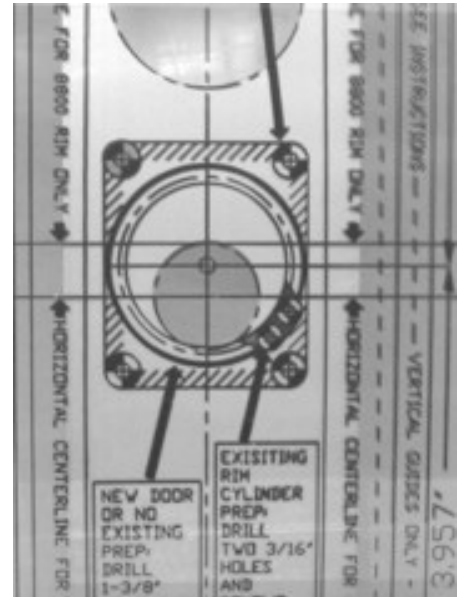

- Drill four 1/4" dia. holes.



- Remove material.



# KC9359/KC9359-2 INSTALLATION INSTRUCTIONS

## Installing the KC9359/KC9359-2

### 18) Prep with Existing Adams Rite® Lever Trim (continued):

- Drill and tap the three #10-32 holes.

**NOTE:** Omit middle hole (a) if it's too close to large trim prep hole to tap properly.

- If optional blind nuts are used, see blind nut installation instructions for hole size and mounting method.

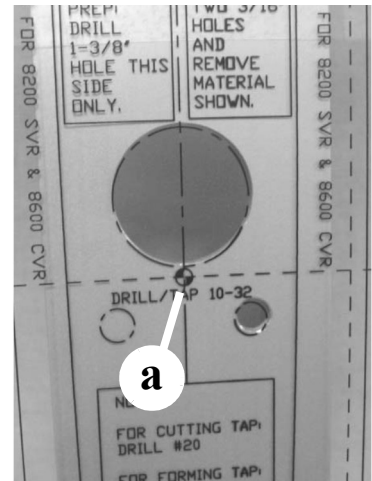

### 19) Install Adapter Housing:

- Using the supplied #8-32 screw, install the adapter housing.



### 20) Apply Trim Gasket:

- Peel paper backing from exterior gasket.
- Carefully apply gasket to trim's baseplate.



# KC9359/KC9359-2 INSTALLATION INSTRUCTIONS

## *Installing the KC9359/KC9359-2*

---

### 21) Position cam:

#### To position cam:

- Open door.
- Depress exit device's push pad.

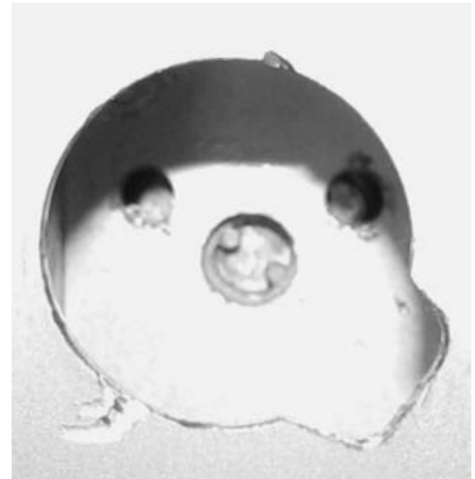

### 22) Place Trim On Door:

- Align trim for with exit device interface.
- Place trim on door.

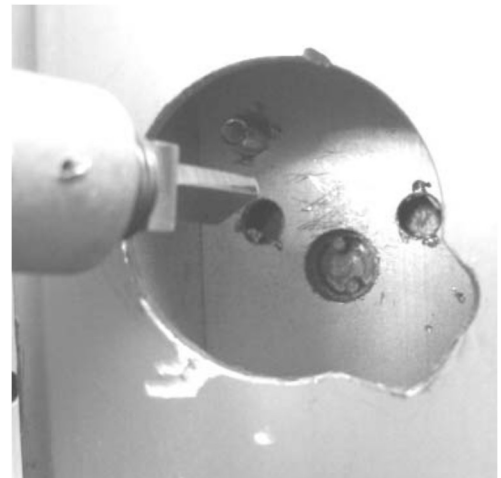

### 23) Partially Tighten Trim's Top Screw

- Using a ball-end, 1/8" hex wrench, partially tighten trim's top screw.

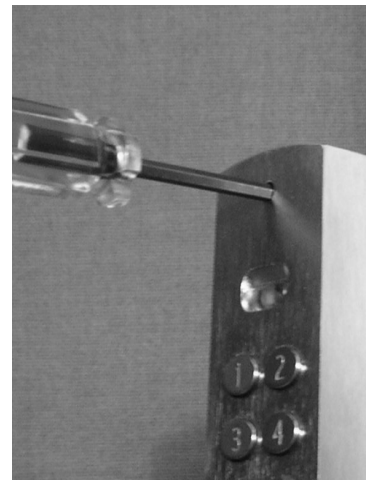



# KC9359/KC9359-2 INSTALLATION INSTRUCTIONS

## Installing the KC9359/KC9359-2

### 24) Remove Battery Cover:

- If not already done, insert key into cylinder and turn it counterclockwise.
- Using a small, flat blade screwdriver, loosen the battery cover screw (a) **ONLY TWO TURNS COUNTERCLOCKWISE**.
- Slide off battery cover (b) from bottom.
- Pull out battery pack from battery compartment. Battery pack is attached to a wire harness.

**IMPORTANT:** Do not cut or attempt to remove the battery pack's wire harness.

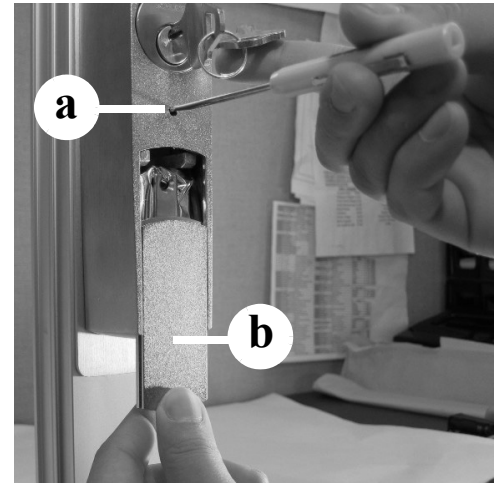

### 25) Install Batteries:

- Remove and retain battery bag.

**IMPORTANT: DO NOT DISCARD BATTERY BAG. IT IS IMPORTANT THAT IT IS REINSTALLED AFTER THE BATTERIES ARE INSTALLED IN BATTERY HOLDER.**

- Observe the polarity markings indicated on battery holder and install four, AAA batteries accordingly.
- Slide battery bag onto battery holder.



### 26) Fold Battery Bag:

- Fold battery bag over.

**IMPORTANT:** The battery bag is used to protect the batteries from moisture and to insulate them electrically from metallic parts.



# KC9359/KC9359-2 INSTALLATION INSTRUCTIONS

## *Installing the KC9359/KC9359-2*

---

### 27) Install Battery Pack:

- Install battery pack into compartment with bag opening facing down.
- Tuck wiring neatly into compartment

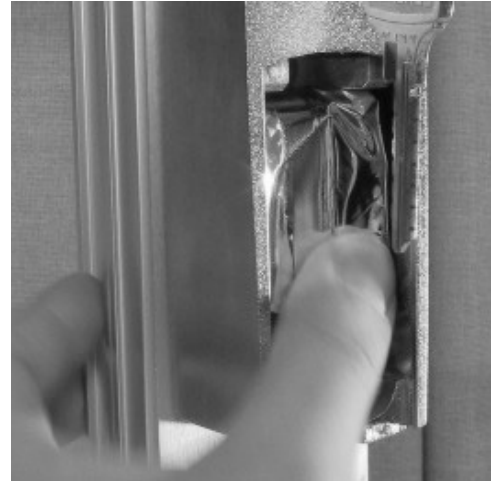

### 28) Install Battery Compartment Cover:

- Slide battery compartment cover on from the bottom.
- IMPORTANT: Use caution not to pinch the battery wires.***

- Tighten battery cover screw.
- Rotate key clockwise.
- Remove key.



### 29) Install Water Plug.

- Insert water plug (a) into top mounting screw hole.
- Using the end of a small Allen wrench or similar tool, push plug into hole past surface.

**INSTALLATION COMPLETE**

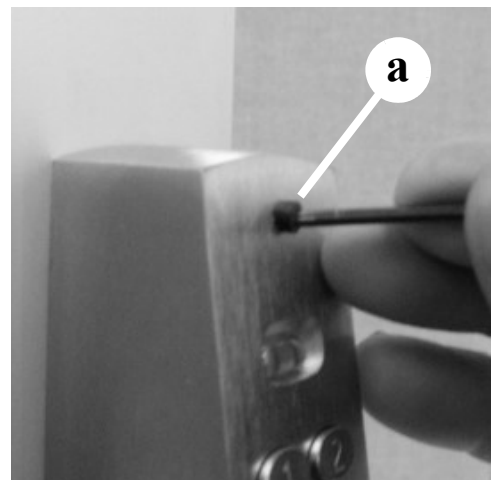

# KC9359/KC9359-2 INSTALLATION INSTRUCTIONS

## Test Operation / Dimensions

### Test Operation

1. Turnpiece should rotate freely.
2. Insert key into cylinder and rotate counterclockwise 180 degrees.
3. Rotate turnpiece counterclockwise to unlock device
  - > Door should be able to be opened.
4. Let go of the turnpiece and close the door
  - > Door should be locked.
5. Remove key.
6. Using the keypad, enter the default access code: **1 3 5 7 9**. The red LED should light each time a button is pressed and when **9** is pressed, the green LED should flash for five seconds during which time the turnpiece should be engaged and door should be able to be opened again.
7. Test exit device to make sure it is operating properly. See to Adams Rite® instructions for more info.

**SEE PROGRAMMING GUIDE FOR PROGRAMMING INFORMATION.**

### Dimensions

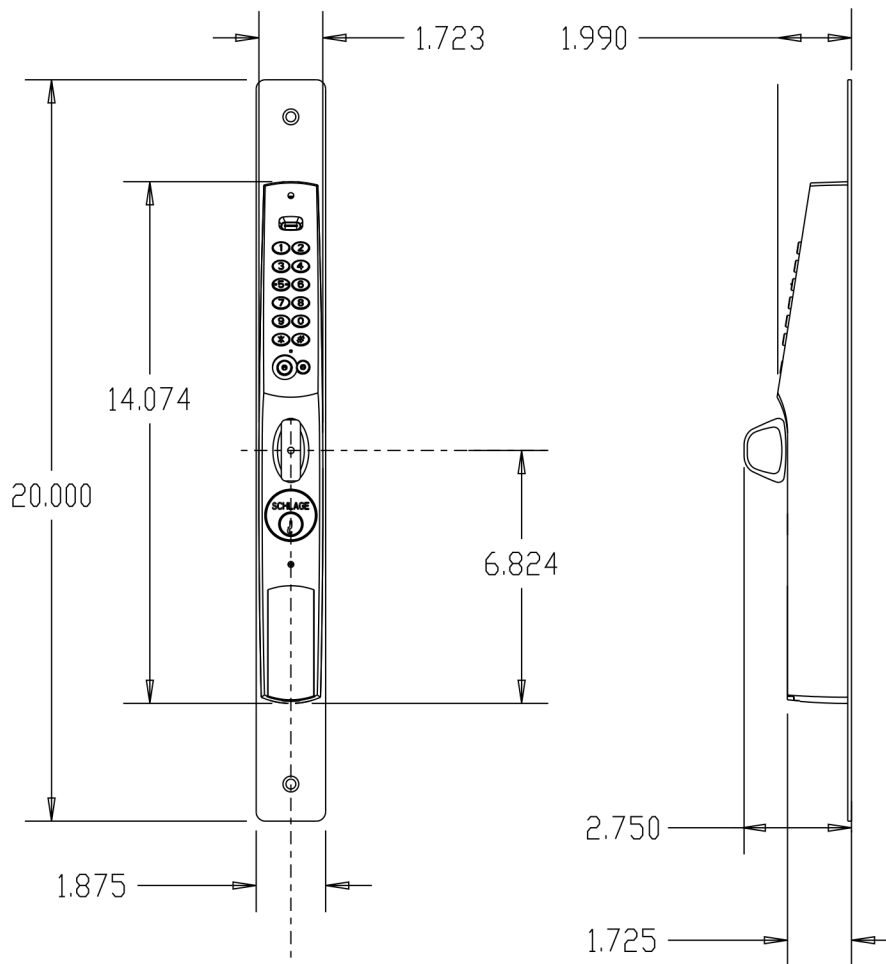

# KC9359/KC9359-2 INSTALLATION INSTRUCTIONS

*Notes*

---

## NOTES