

Additional Notes:
1 sheet, 1 fold

Revision History						Revision Description:					
D	E	F	G	H	K	E > Allegion rebranding.					
20156	062621										
Material						Edited By		Approved By		EC Number	Release Date
White Paper						R. Byun		M. Roberts		062621	05-14-2015
Notes						Title					
<ol style="list-style-type: none"> printed two sides printed black tolerance: ± .13 see sheet 2 for artwork printed in country may vary drawings not to scale 						F-Series Circuit Board Firmware Upgrade Instruction					
Creation Date			Number			Revision					
08-29-11			70200-0010			E					
Created By			Activity								
J. Ellis			3899 Hancock Expwy								
Software: Illustrator CS6			Security, CO 80911						Allegion Copyright © 2015		



70200-0010

F Series Circuit Board Firmware Upgrade



Installation Instructions

Periodically, enhancements to the HandKey or HandPunch are introduced that offer added functionality and performance. Should it be necessary to incorporate the enhancements into the F Series circuit board (HP-2000, HP-3000, HP-4000, HK-2 and HK-CR), use the following procedures.

▲ CAUTION: This procedure requires erasing the existing hand templates. Save the existing hand templates before proceeding.

1. Unlock the reader and rotate.

▲ CAUTION: If the unit is equipped with an optional battery backup, remove the J7 jumper before proceeding. Refer to figure 2 on the next page for location of J7.

2. Disconnect the power supply from the board.
3. Remove and tag all external connections to make correct re-attachment.
4. Remove HandReader from wall by sliding it to the right, away from the wall mount. See figure 1 below.

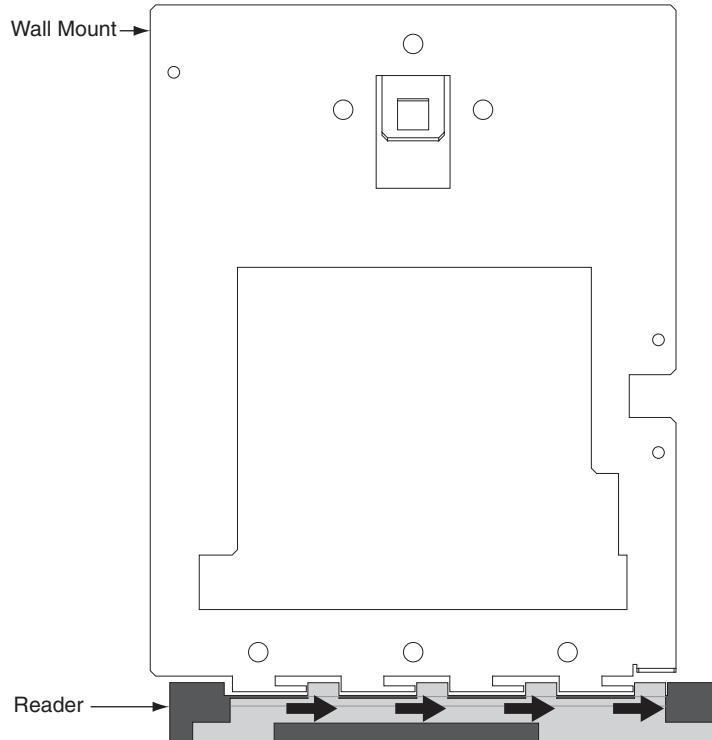

Figure 1

▲ CAUTION: Before removing back plate of reader, wear a grounding wrist strap to help aid in protecting the circuit board from any ESD damage that might occur from improper handling.

5. Set the reader on a firm surface such as a table. Remove the four screws that secure the back plate to the HandReader. Remove the grounding screw and/or ground lug (if present). See figure 2 on next page.

Customer Service

1-877-671-7011 www.allegion.com



© Allegion 2015
Printed in U.S.A.
70200-0010 Rev. 05/15-e

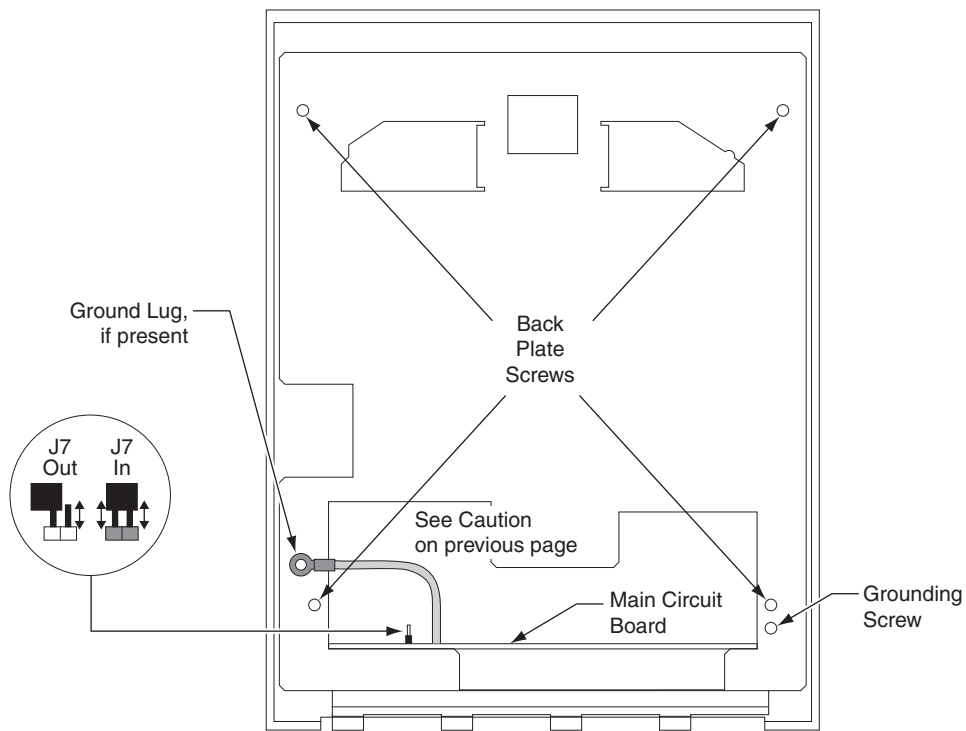

Figure 2

6. Remove the back plate.
7. Locate the cable that runs from the top panel circuit board to the main circuit board. Disconnect this cable from J9 on the main circuit board. See "1" on figure 3. To remove the J9 connector on the main circuit board (lower board), depress the retaining clip on the connector and pull upwards. See figure 4 below.

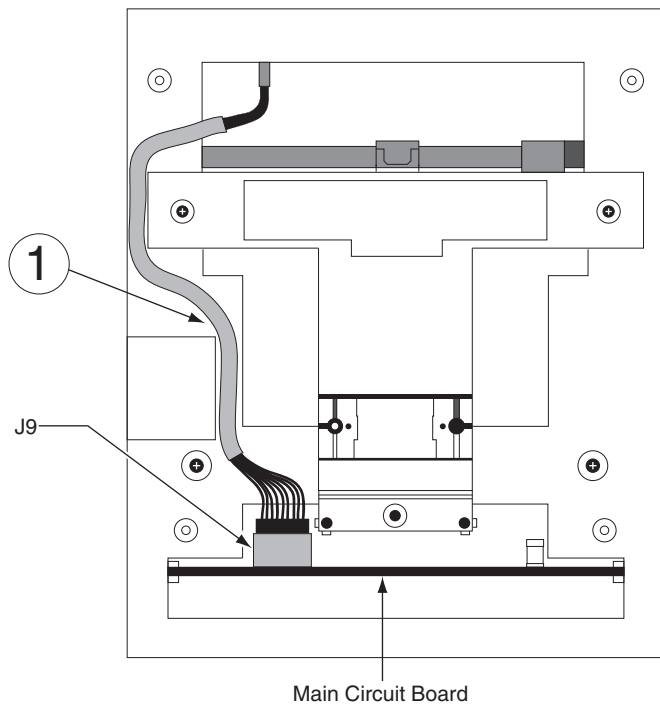

Figure 3

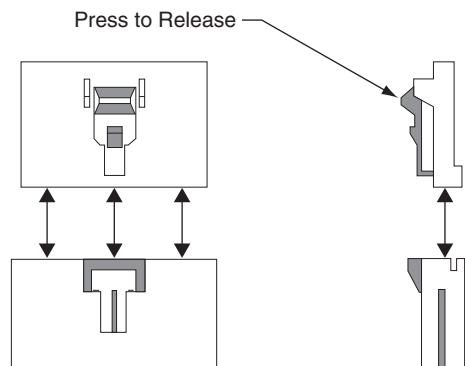

Figure 4

8. Carefully slide the main circuit board out until the ribbon cable between the camera assembly and J2 on the main circuit board is accessible. First, disconnect the J5 connector from the main board. To remove, depress the retaining clip on the J5 connector and pull upwards. See "2" on figure 5 on the following page. Next, remove the ribbon cable from J2 by gently pulling up on this cable, being careful not to pull down as damage may occur to the camera assembly. See "3" on figure 5 on the following page.

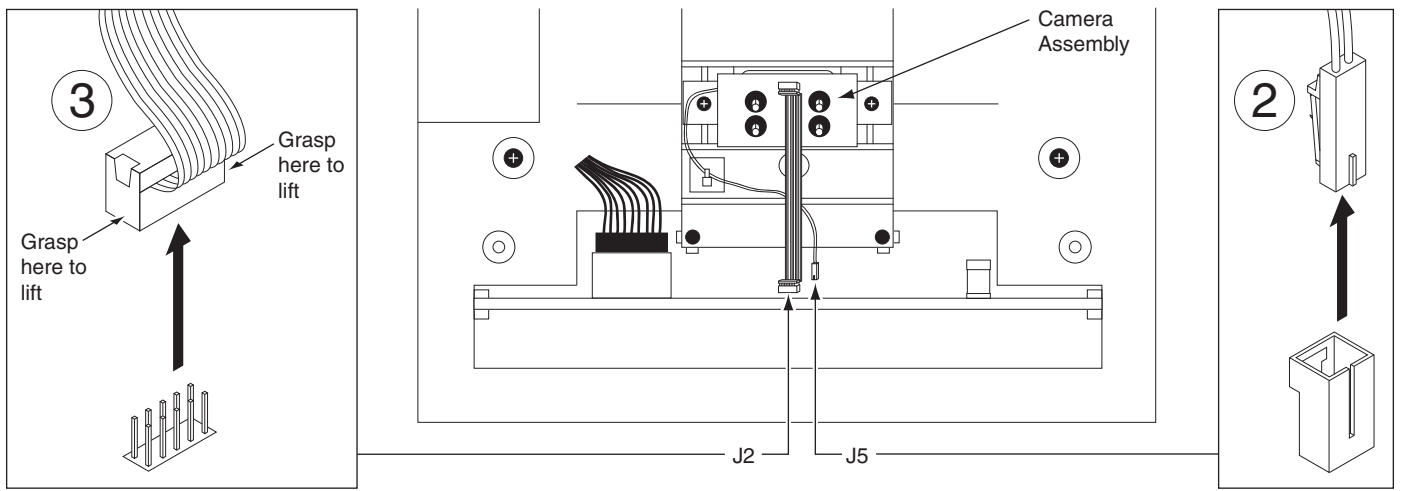

Figure 5

9. Carefully remove the main circuit board by sliding it free from the chassis.
10. On the bottom side of the board, locate the PROM socket labeled U24. Please take notice that there is a flat corner located in the lower right corner of the socket. This flat corner will align with a flat corner on the PROM. See figure 6 below.

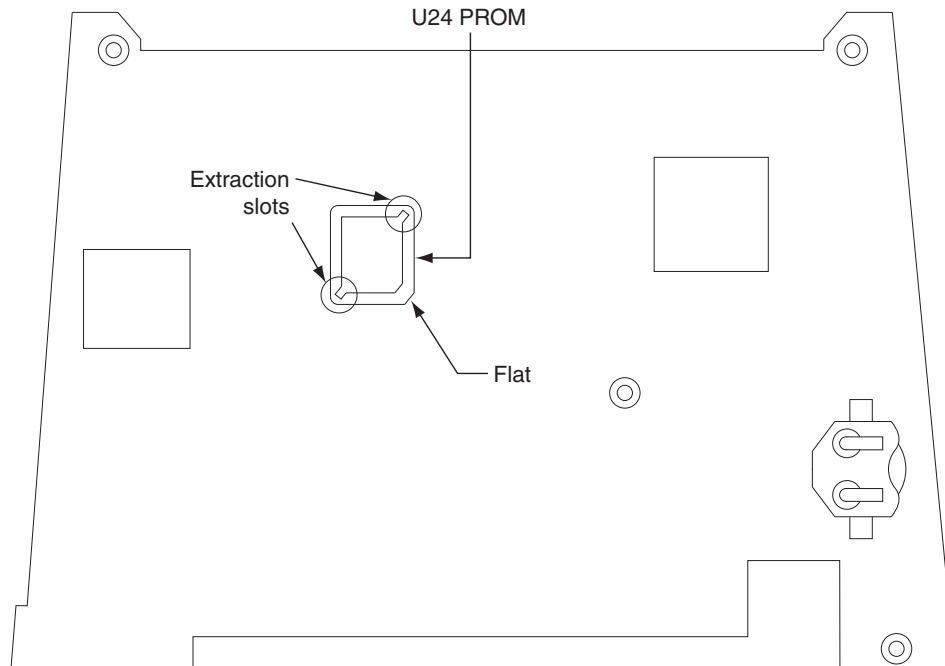

Figure 6

11. Remove the PROM currently installed in the U24 PROM socket using the steps below in conjunction with the provided PROM extraction tool.
 - a. Insert the extraction tips into the extraction slots of the socket until the tool bottoms on the socket. See figure 7, drawing number 1 for details.
 - b. Squeeze the tool handles until the PROM backs out of the socket. See figure 7, drawing number 2 for details.

▲ CAUTION: Do NOT pull upward on the tool to loosen the PROM – slowly squeeze the tool handles while maintaining a slight downward force toward the socket.

- c. Remove the PROM and tool.
- d. Inspect the PROM socket and socket pins for any damage or misalignment.
- e. Store the original PROM in a safe location so it does not get confused with the new PROM.

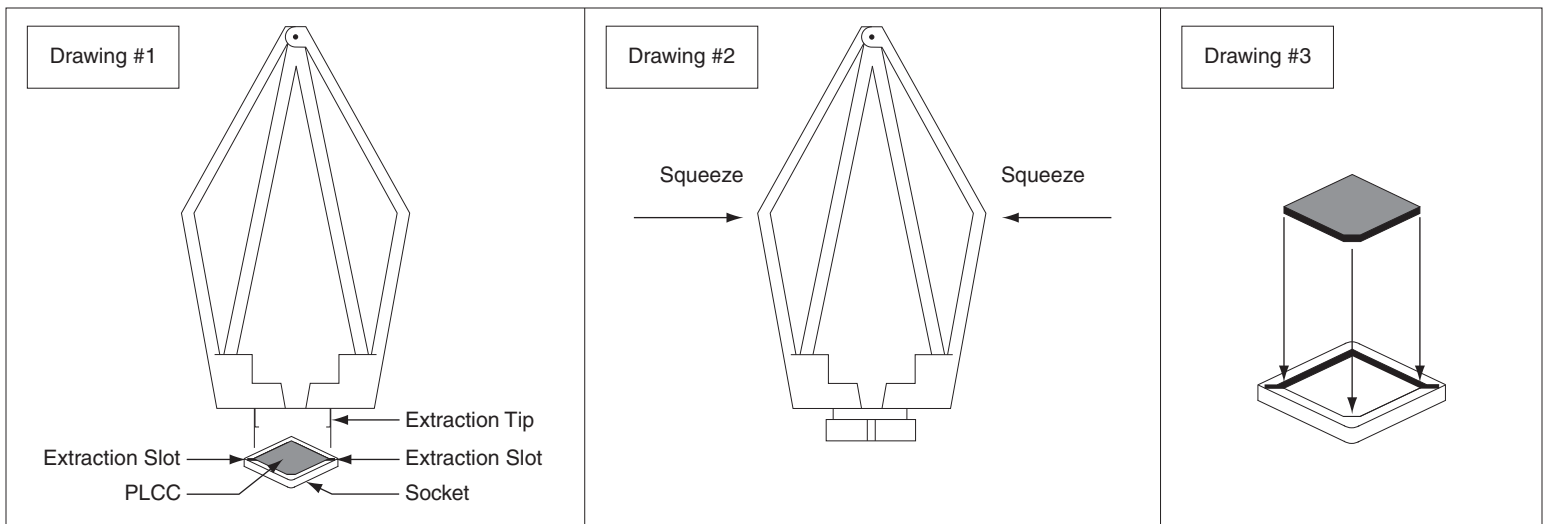

Figure 7

12. Install the new PROM in the U24 PROM socket using the steps below.
 - a. Inspect the pins of the new PROM for bent or misaligned pins.
 - b. Place the new PROM over the socket, aligning the flat corner of the PROM with the flat corner of the socket. See figure 7, drawing number 3 for details.
 - c. Gently press the PROM down into the socket until it snaps into place.
 - d. Inspect the PROM to insure that it has been fully seated in the socket.

Re-installing

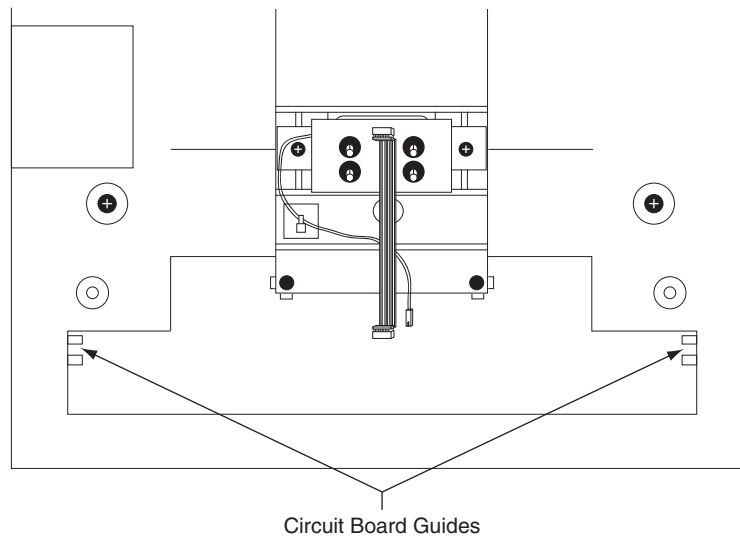

Figure 8

13. Being careful to align all pins, attach the camera cable to J2 on the main circuit board.
14. Plug in the J5 connector.
15. Locate the cable that runs from the top panel circuit board to the main circuit board. Connect this cable to J9 on the main circuit board. Make sure the connector snaps into J9.
16. Replace the back plate. Attach the grounding screw to the main circuit board using the lower right hole on the back plate. If a ground lug is present, do not allow it to come into contact with J7.
17. Secure the back plate with the four screws removed in step 5.
18. Line up the slots at the bottom of the reader's back with the four hinge pins at the bottom of the wall mount. Slide the reader to the left so the pins go in the slots. This fastens the reader to the wall and wall mount and forms a hinge.
19. Reconnect all external connections removed in step 3.
20. Power up the unit and install J7 (if applicable).
21. Secure the unit to wall mount with key. Upgrade is completed.